



DXi

POWERED BY **LAGUNA**

USER MANUAL



Table of Contents

Chapter 1: Introduction	1
About the Controller	1
DXi Controller Hardware Configurations	3
About This Manual	6
Icons Explained	7
Getting Help	8
Chapter 2: Overview	9
The Faceplate	9
The Buttons	10
The LEDs	11
The Screen	11
Menu Navigation	12
Chapter 3: Quick Start	13
Setting Current Date and Time	14
Creating a New Irrigation Schedule	14
Program Start Time	15
Water Days	16
Station Run Times	17
Program Hold	18
% Adjust	19
Manual Operation	20
Chapter 4: Setup	23
Flow	24
Learn Flow/Current	28
Omit by Date	29
Communication	30
• Submaster	30
• Cloud Connect	31
• Ethernet	32
• WiFi	32
• M7/M8 Radio	33
• Cellular	33
Current Checks	34
Time/Date	35
Firmware Update	35
FLOW MAX	36
Station Count	36
Master Valves & Pumps	37
Program Decoder	38
Chapter 5: Program Entry	39
Start Times	40
Water Days	40
Run Times	41
Quick Stations	41
Program Hold	42
OPT INs	43
Erase/Reset	45
% Adjust	45
Backup Programs 10 & 11	46
Chapter 6: Stations	47
Flow	47
Current	48
Cycle & Soak	49
Chapter 7: Reports and Diagnostics	51
Reports	51

Diagnostics - General	53
Diagnostics - Communications	55
Communications.....	57
Chapter 8: Alerts	59
Analyzing an Alert.....	60
Alerts and Corrective Action.....	62
Chapter 9: Rain Hold	67
Chapter 10: Manual Operation	69
Station.....	70
Simultaneous	71
Sequence	72
Program.....	73
Chapter 11: Review.....	75
Overview.....	75
System Review	76
Program Review.....	77
Station Review.....	79
Flow Review.....	80
About.....	80
Weather Review	81
Chapter 12: Troubleshooting.....	83
Communications Wiring Issues (Satellite to Satellite).....	83
Directory of Flow Chart Diagnostic Problems.....	86
Control Devices (Rain Sensors, Freeze sensors, Etc.).....	101
Appendix A: Specifications	103
Appendix B: Flow Sensors	105
Flow Sensor Installation Instructions	106
Flow Sensor Overview	106
Flow Sensor Offset and K Values.....	107
Flow Limit Checking	108
Flow Limit Violations.....	111
Appendix C: Current Alarms Within a Conventionally Wired DXi System.....	114
Appendix D: Setting Up a FLOW MAX System	121
Overview.....	122
Physical Configuration.....	124
Flow Max Setup Procedure	127
Flow Max Flow Limits	128
Satellite Controllers	129
Flow Max Worksheet.....	131
Flow Max Diagnostic Tools	134
Flow Max Warnings and Exception Conditions.....	136
Appendix E: Hardwired Communication Troubleshooting	137
Normal Operating Behavior:	138
Inspecting Field Wiring:	141
Appendix F: Grounding the Communication Cable	143
Glossary.....	147
Index	153
FCC Notice - Electromagnetic Compatibility.....	155
Toro LIMITED WARRANTY	156
California Proposition 65 Warning Information.....	157
Notes	159

Chapter 1: Introduction

Thank you for supporting Toro® and the Rain Master Laguna™ / DXi™ central control platform. As the long-awaited successor to the Evolution™ DX2 controller, we hope the DXi will exceed your expectations and contribute to Toro's legacy of innovation and service.

About the Controller

Toro believes in minimizing waste by maximizing water application efficiency. The DXi provides precise control of irrigation delivery systems through a flexible network that could fit almost any application. DXi will work with your Toro Laguna software to monitor, adjust, and report on irrigation schedules to your technical comfort level.

Hardware Features

Capacity:

- Up to 96 stations per satellite in conventional configurations, 200 stations per controller in two-wire (TWICE™) configurations.
- Up to 48 conventional stations and 152 two-wire stations in our hybrid models (for TWICE two-wire conversion projects).
- Three dedicated master valve (MV) outputs, either normally closed or normally open.
- Two auxiliary 24VAC relays for pumps, lights, etc.
- Three inputs to connect flow sensors/meters and three inputs for rain, wind, and ET pulsed data devices. Note that these devices would be independent of the optional LAGUNA wireless weather solutions, which are all wireless.
- Three alarm inputs
- An expansive, 4.4" LCD back-lit display with rapid menu navigation and "digital

ink” for high visibility in the sun.

- Integrated cabinet access lighting or “fridge light” and pivoting brackets for improved setup and service access (select models).
- Transparent, custom – fit plastic covers for all circuit boards for added protection against the elements and pests.
- Many system communication options, including cellular, UHF Radio, Ethernet-to-Radio, Ethernet, Hardwire, WiFi and more!
- Lightning protection up to 18kV.
- Integrated amperage meter to enhance internal diagnostics and troubleshooting
- Up to 21 simultaneous station-related operations (sixteen valves, three MVs, and two pumps).

Scheduling and Programming Features

- 16 conventional programs with up to 12 start times per program as well as two additional "grow in" programs.
- Exclusive DX series Individual Station Control (ISC™): Treat every active station as an individual program
- Customizable scheduling calendar with up to 48 exclusion days
- Programmable MV and Station Delay
- Global water window (Manual can override)

Maintenance and Alarm Diagnostic Capabilities

- Flow monitoring. Overflow, underflow, unscheduled flow, and catastrophic occurrence monitoring and reporting.
- Electrical alarm with station shutdown and program advance for station/s over current, shorts, damaged wires, and/or faulty solenoids.
- Power outage restoration alarms.
- LED indication for station outputs.
- Electrical self diagnostic test to identify specific station output faults.
- Manual test mode that can advance stations while displaying valve electrical current and station flow data.

Communication Features

The DXi is capable of communicating with the Central computer over a variety of communication technologies.

Ethernet	Standard on all DXi systems.
Cellular	Optional accessory for Central to field controller communication.
WiFi	“Short range” standard WiFi to Central, sold as an optional accessory.
Ethernet-to-Radio	Part number DXI-ETHER-RF-RPTR Sold as an optional stand-alone accessory.
UHF Radio	Sold as an optional stand-alone or embedded accessory.
Serial cable	Serial communication to Central or Diagnostic PC.

DXi Controller Hardware Configurations

Controller hardware can be specified in hundreds of different product configurations. The controller that was purchased by Toro customers was specified to have a certain hardware configuration. These configurations are a combination of the following product characteristics:

- Whether it is a Sentinel or a Laguna
- One of six different enclosures: SWM, PWM, PSB, SPED, PPED and DPSB
- Whether it has a conventional output station or uses two-wired outputs (exception is SPED which can come as a “Hybrid”: two-wire AND conventional output support)
- The number of conventional outputs (multiples of 8)
- Communication option/s, if any. This could be cellular, WiFi or UHF radio. Communication option hardware is just that- optional. Communication to the cloud or to central software is still accomplished through standard Ethernet. Communication option is only needed in cases where Ethernet is not available.
- Optional WOB controller kit (only on Sentinel models)
- Pro Max remote control receiver kit option

Each of the above listed product characteristic is associated with a product code on the product’s label. The result of these combinations is an encoded label. This label can then be decoded by the customer to determine if he/she has purchased the right controller for their needs.

The listing below shows all the controller characteristics along with their codes:

Controller Model

DXi	DXi Irrigation Controller
-----	---------------------------

Firmware

DXi-FMW-LAGUNA	DXi With Laguna Firmware
DXi-FMW-WMS	DXi with Sentinel Firmware

Enclosure Type

PWM	Painted Wall Mount Enclosure
SWM	Stainless Steel Wall Mount Enclosure
SPED	Stainless Steel Pedestal Enclosure, Type 1
PSB	Stainless Steel Pedestal Enclosure, Type 2
PPED	Plastic Pedestal Enclosure
DPSB	Stainless Steel Pedestal Double Wide Enclosure*

Station Count

TW	200-Station 2-Wire Output Gateway
08	8-Station Conventional Output
16	16-Station Conventional Output
24	24-Station Conventional Output
32	32-Station Conventional Output
40	40-Station Conventional Output
48	48-Station Conventional Output
56	56-Station Conventional Output, DPSB Enclosure Only
64	64-Station Conventional Output, DPSB Enclosure Only
72	72-Station Conventional Output, DPSB Enclosure Only
80	Station Conventional Output, DPSB Enclosure Only
88	Station Conventional Output, DPSB Enclosure Only
96	Station Conventional Output, DPSB Enclosure Only
HY08	8-Station Conventional Output With TW Output Gateway, SPED Enclosure Only
HY16	16-Station Conventional Output With TW Output Gateway, SPED Enclosure Only
HY24	24-Station Conventional Output With TW Output Gateway, SPED Enclosure Only
HY32	32-Station Conventional Output With TW Output Gateway, SPED Enclosure Only
HY40	40-Station Conventional Output With TW Output Gateway, SPED Enclosure Only
HY48	48-Station Conventional Output With TW Output Gateway, SPED Enclosure Only

Communication Add-on

M8C	Cellular Kit
M8W	WiFi Kit
M8U	UHF Radio Kit

Other Add-ons

P	ProMax Remote Receiver Kit
E	WOB Controller- 900MHZ XTND Radio Kit (WMS DXi Only)
PE	Pro Max Remote Receiver Kit with 900MHZ XTND Radio Kit (WMS DXi Only)

Some examples:

A product label that reads DXi-PWMTWM8WE is therefore a DXi Painted Wall Mount controller (PWM) with a Two-Wire Output (TW), a Communication option that uses WiFi (M8W) and a WOB Controller radio kit (E). Because of the presence of the WOB controller radio kit, this controller can only support Sentinel Firmware (DXi-FMW-WMS).

A product label that reads DXi-SPED40M8UPE is a DXi Stainless Steel Pedestal controller (SPED) with 40 conventional output station controls (40), a UHF radio communications option (M8U), a Pro Max remote control receiver (P) and a WOB controller radio kit (E). Because of the presence of the WOB controller radio kit, this controller can only support Sentinel Firmware (DXi-FMW-WMS).

A product label that reads DXi-DPSB64PE is a DXi Double Wide Stainless Steel Controller (DPSB) with 64 conventional output station controls (64), a Pro Max remote receiver (P), and a WOB controller radio kit (E). Because of the presence of the WOB controller radio kit, this controller can only support Sentinel Firmware (DXi-FMW-WMS).

A product label that reads DXi-SPEDHY48M8U is a DXi Stainless Steel Pedestal (SPED) with hybrid two-wire and conventional output support for 48 stations (48), with UHF radio as the communication option. Because there is no WOB controller radio kit in the product, it could either be a Sentinel or a Laguna controller. The controller's firmware can be identified by reading the "About" screen under the Review button function on the face plate.

About This Manual

This manual is divided into five sections:

1. A **Quick Start** tutorial on quickly getting an irrigation program going as well as other common irrigation tasks.
2. A **Reference** section with every command explained.
3. A **Maintenance and Troubleshooting** section to help you, the operator, resolve any problems or questions you might have quickly and effectively.
4. **Appendices**
 - **A: Specification**
 - **B: Flow Meters**
 - **C: Current Monitoring**
 - **D: Flow Max**
 - **E: Hardwired Communication Troubleshooting**
 - **F: Grounding the Communication Cable**
5. A **glossary** and **index**.

Icons Explained



A note to clarify.



Important



Warning! Risk of electric shock



Press the specified button.



Rotate the Control Dial.



Press the Control Dial.



The box indicates which field can be changed.
When the value flashes, it is ready to be changed.

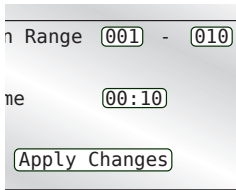

Adjustable Fields.



to switch between the different fields.



to switch between values in date, time, and run time fields.

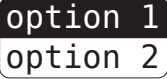

Press the Control Dial to adjust values in this field.
There are typically two values in a field like this.

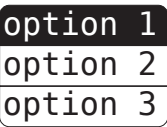

Change values in this field with the Control Dial.



For numeric fields only.
Change number values with the Control Dial.

Getting Help

Toro strives to build safe, durable, and easy to use product. If, however, you encounter a problem that is not easily resolved with the troubleshooting solutions offered in **"Chapter 12: Troubleshooting" on page 83**, please contact an authorized Toro product expert for assistance via phone or email.

U.S./Canada:

Phone: 1-800-777-1477 (7:30 am–4 pm, M–F, PT)

E-mail: irrigationsupport@toro.com







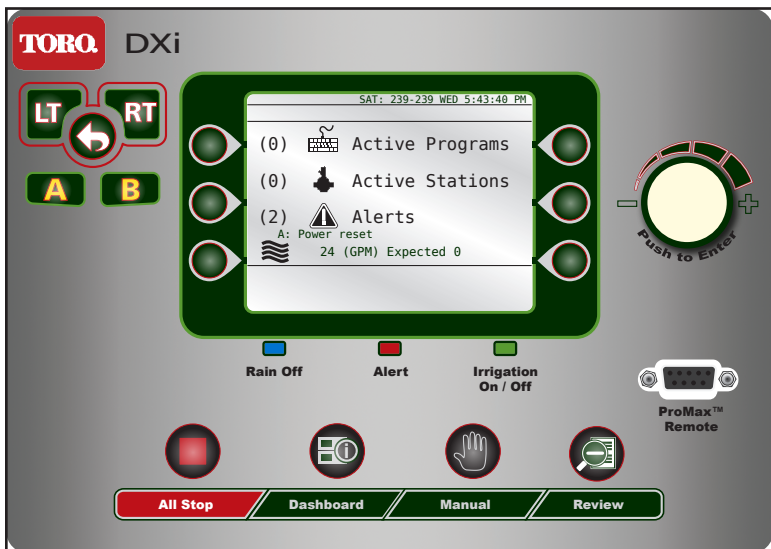

Chapter 2: Overview

Because not all irrigation applications are identical, the DXi controller has been designed to allow users to establish a wide variety of individual programmable options. These options include changing global settings, program configurations, station settings, communication type and sensor shutdown criteria.

The Faceplate



The Buttons

Button	Function
	<p>Control Dial</p> <p>Rotate to switch between fields on a screen and change values within those fields.</p> <p>Press to enter a desired field and to save the value.</p>
	<p>Left, Right, and Back buttons</p> <p>To navigate screen and menu selections.</p>
	<p>“A” button functionality is defined on the screen when operable.</p>
	<p>“B” button functionality is defined on the screen when operable.</p>
	<p>Command button</p> <p>To execute the on-screen command closest to that particular command button.</p>
	<p>All Stop</p> <p>To stop all current irrigation activity.</p>
	<p>Manual</p> <p>To manually operate the controller.</p>
	<p>Dashboard</p> <p>To return the controller to the “Dashboard” screen.</p>
	<p>Review</p> <p>To review a variety of predefined topics.</p>

The LEDs

The DXi has three LEDs beneath the main LCD screen. Each LED illuminates for a specific reason:



Rain Off (blue)	Illuminated when the Rain Off command is active. All irrigation activity is suspended when this light is on.
Alert (red)	Illuminated when a user alert for the operator has been triggered, such as after a loss of power or station operation issue. Alerts must be manually cleared in the Alert submenu.
Irrigation (green, red, or no illumination)	Illuminates green when irrigation is actively in operation. Illuminates red when no valid program is scheduled to irrigate for the day. No illumination when a valid program is scheduled to irrigate today, but is not actively irrigating.

The Screen

The Liquid Crystal Display (LCD) screen on the DXi controller is 4.4” QVGA monochrome display screen.

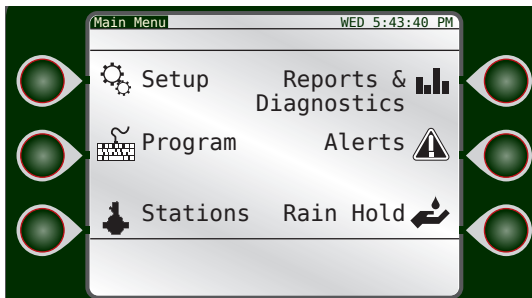



The main menu

On both sides of the screen are three command buttons for quick and easy execution of the button’s assigned command.

Menu Navigation

Navigating menus and executing commands in the DXi is easy with the various buttons and the Control Dial.

To navigate the typical DXi screen, we will use the below as an example.

Press  and  to move between the different “top” screens.

Some fields have preset options.
 Press  to switch between them.

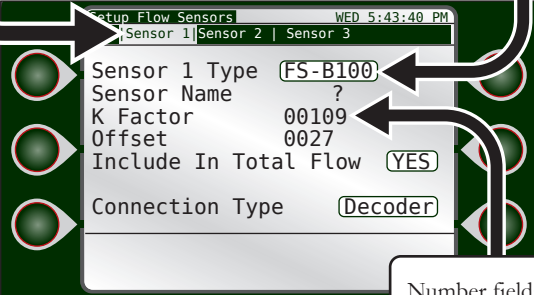

Number fields must be adjusted by .

Navigating and Executing

1.  to navigate between adjustable fields.
The “active” field will have a black box around it.

2.  to enter the “active” field.

3.  to adjust the value.

 Some fields have preset options like “Custom” vs. “Data Ind”. Other fields are numeric and are adjusted incrementally.

4.  to set desired option.



5. Repeat steps 1 - 4 for all adjustable fields.

Chapter 3: Quick Start

This chapter is a step-by-step tutorial for rapid and basic controller setup. For the demonstration, we will set up an irrigation schedule with 2 start times: 6:15am and 8pm daily, 1 cycle at 10 minutes per station.

 *The Quick Start guide does not address advanced features such as sensors (Chapter 4), flow (Appendix B), ET, or FLOWMAX (Appendix C).*

Before we can program an irrigation schedule, we must enter the date and time.

To get to the Setup screen from the Dashboard, press the Control dial  or any one of the Command buttons .

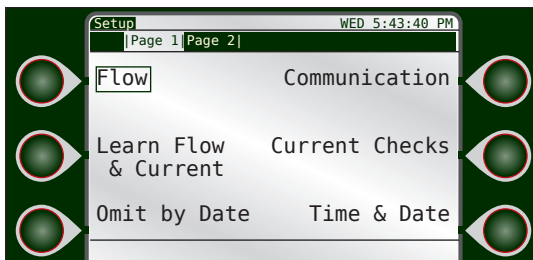

The Setup Screen

Setting Current Date and Time

1)  Setup

2)  Time/Date

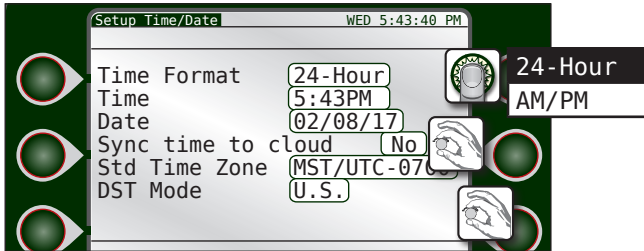

3)  Switch between the 3 time/date fields.

4) Using the navigation techniques from page 14, adjust fields as necessary.

5) Repeat as necessary for the other fields. When done, press



Station Count

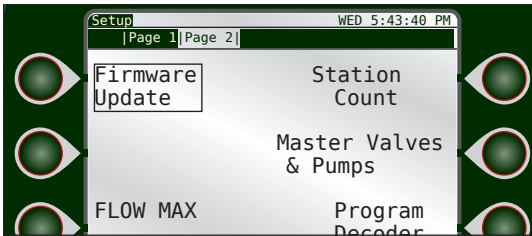

Page 2 of the Setup menu shows Station Count.

Setting the correct number of stations for the DXi system is required for proper controller operation. The station count variable dictates how many stations participate in the Learn Current/Flow events. If the wrong number of stations are entered, the Learn Current and Learn Flow events do not operate correctly.

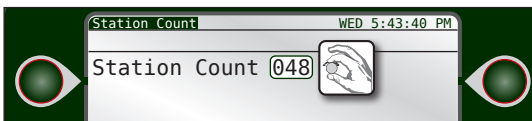

Communication with Central

DXi controllers can communicate with a Central computer running Laguna so that the Central can manage multiple controllers. For information on setting up this system-wide communication, please go to page 30.

Creating a New Irrigation Schedule

Now that the date and time are set, we can set up the irrigation schedule.

Program Start Time



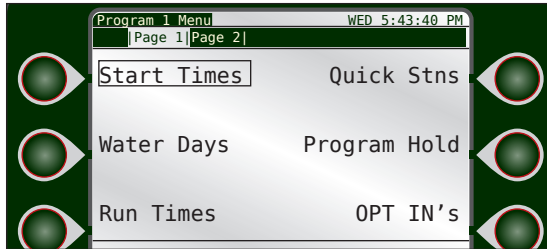

- 1)   Program
- 2)  Program 1

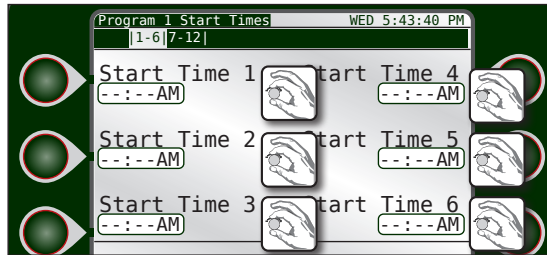

- 3)  Start Times



It is possible to have 12 start times per program.

- 4)  and  to adjust the first start time to 6:15am.
 - 5)  and  to adjust Start Time 2 to 8:00pm.
-  Press 'A' to clear start times.

- 6) When done, press .

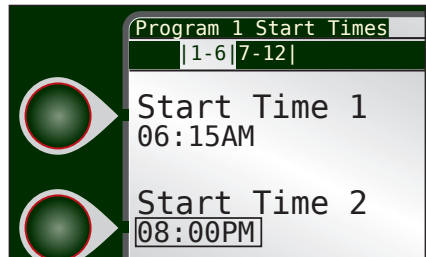

Start times set!

Water Days

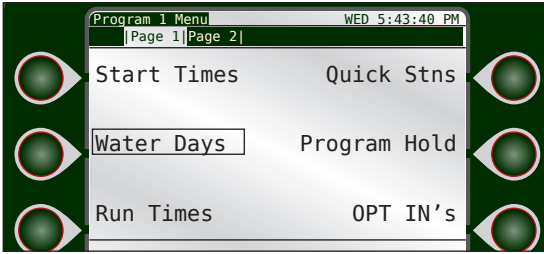

1) Water Days

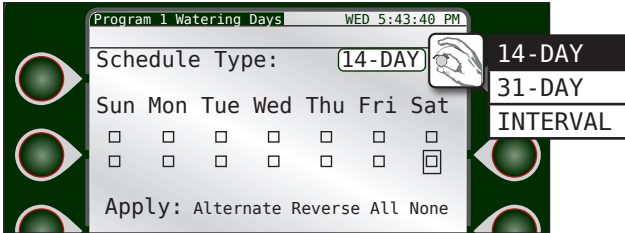

- 2) Enter **Schedule Type** field. 3) Change to desired schedule. I chose **31-DAY**.

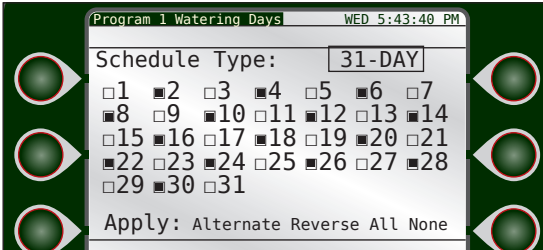

- 4) Set Schedule Type. 5) to **Alternate**.

- 6) Set **Alternate**. 7) When done, press

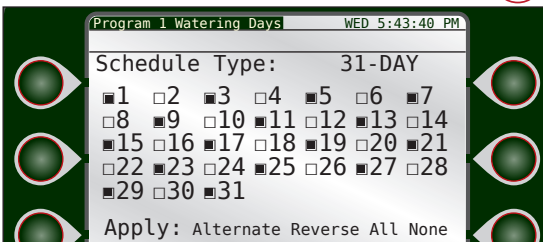

Alternate days are active.



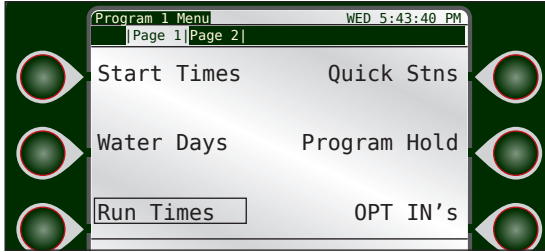

Station Run Times

1)  Run Times

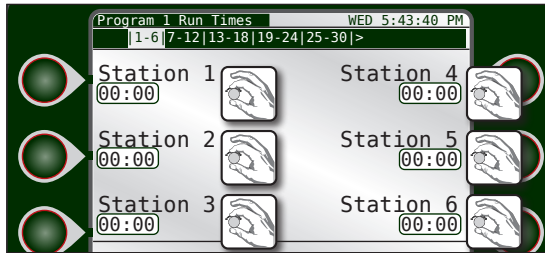

- 2)  Enter **Station 1** hours field. Our run time will only be for ten minutes, so we can switch to the minutes field.



- 3)  Switch to minutes field.
- 4)  Adjust desired run time in minutes.
- 5)  Set Station 1 run time.
- 6)  Switch to next Station field.
- 7) Repeat steps 2-6 for as necessary for as many stations as desired.

 Press 'A' to clear run times.

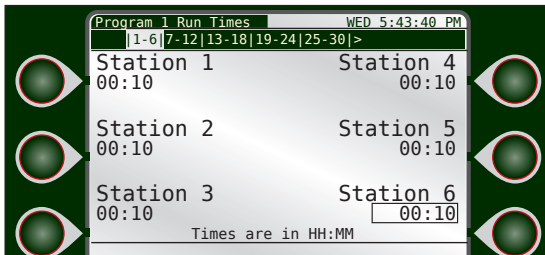

Stations 1 - 6 set with ten minute run-times.

 Run time can be entered as either HH:MM or MM:SS. See "Run Times", Chapter 5 for instructions on how to switch between the two formats.

Program Hold

A storm is coming! Irrigation will not be needed for a few days. Let's activate a Program Hold on Program 1.

1)   Program

2)  Program 1

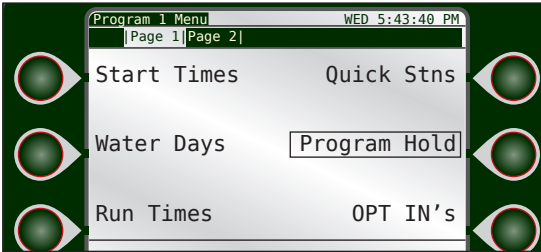

3)  Program Hold

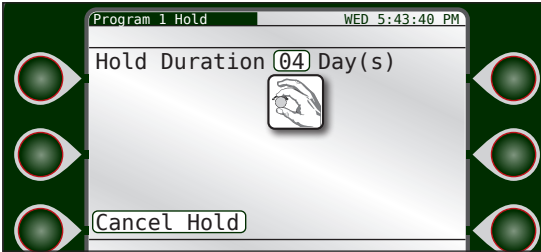

4)  Enter **Set Day(s)** field.

5)  Change to desired days. 4 days to dry out.

6)  Set value.

7) When done, press 

 *Activating a Program Hold will cause the Rain Off LED to illuminate.*

% Adjust

The weather overall is getting cooler.

Let us decrease the overall amount of irrigation for this program.

1)   Program

2)  Program 1

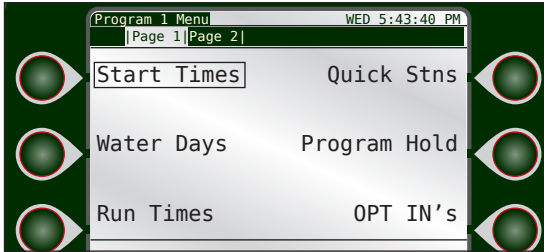

3)  to get to the Page 2 Program 1 Menu screen.

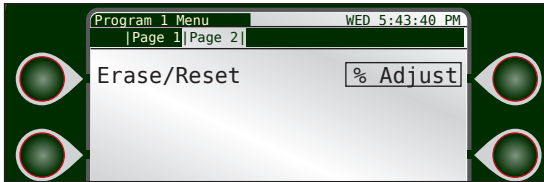

4)  % Adjust

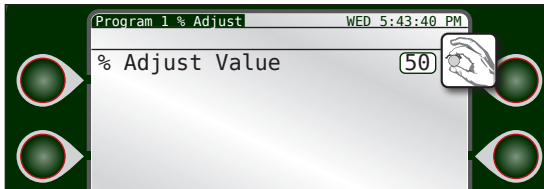

5)  Enter % Adjust field.

6)  Change to desired %.
I reduced to 50%.

7)  Set value.

8) When done, press 

 Above, we set our run times to ten minutes per station.
A 50% runtime would therefore cut that in half, to five minutes.

Manual Operation





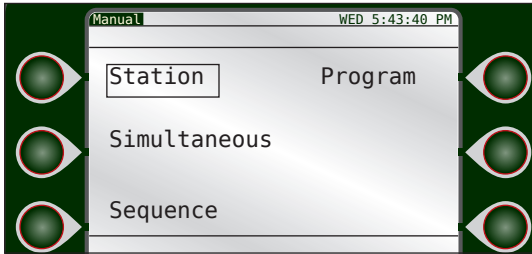



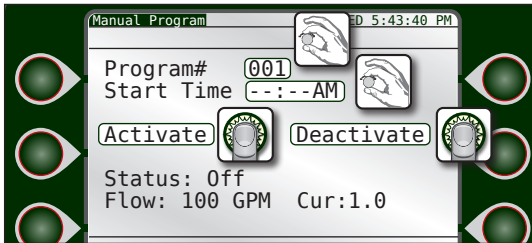



The grass is a little dry. Let us run a manual program operation at 10pm to help keep that grass green.

- 1) Press the  Manual button.



- 2)  Program



- 3)  Enter **Program#** field.
- 4)  Select program to run. I chose **1**.
- 5)  Set Program value.
- 6)  Navigate to **Start Time** field.
- 7)  Enter **Start Time** field. Hours field will flash.
- 8)  Change hour value to 10.
- 9)  Switch to minute field.
- 10)  Switch to AM/PM field.
- 11)  Change to PM.
- 12)  Set value.
- 13) When done,  to the **Activate** field and  .
The operation will execute this evening and save the grass.

 *Programs started by Manual Operation run only once.*

Reference

The rest of this manual is dedicated to explaining every function and command available to the DXi controller, organized by the Main Menu categories below.

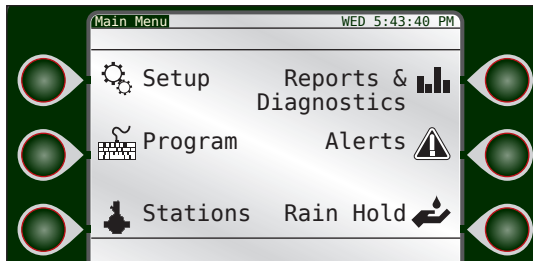

Command	Chapter
Setup	4
Program	5
Stations	6
Reports & Diagnostics	7
Alerts	8
Rain Hold	9

Chapter 4: Setup

This chapter describes every function within the Setup section of the controller.

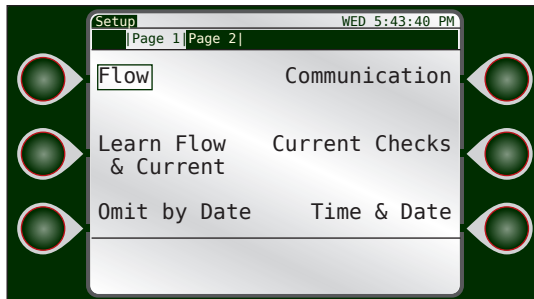

All step-by-step directions are started from the above Setup screen.

 Press  or  to get to Page 2 and/or 3 of the Setup options.

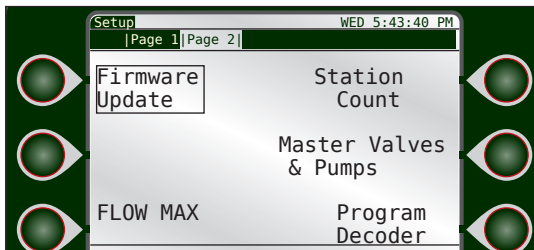

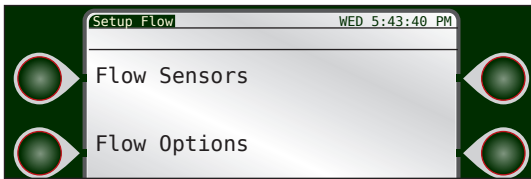

Second screen of Setup options

Flow



Flow Sensors

Flow Sensors can calculate and report the amount of water, in gallons per minute, travelling through a pipe. For a complete explanation on flow sensors, including basic instructions on how to install a flow sensor, please see **Appendix B: Flow Sensors**.

1.  Flow
2.  Flow Sensors
3.  to navigate to field to set. Fields that can be changed are: **Sensor Type**, **K Factor**, **Offset**, and **Include In Total Flow** calculations or not.

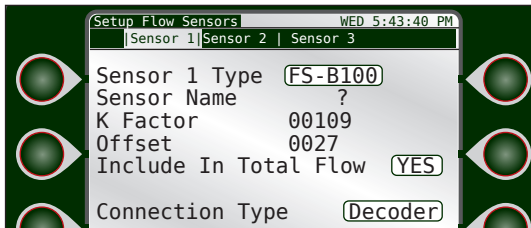

Include in Total Flow: If checked No, the flow sensor data from this sensor will be ignored for Total Flow count. Note the flow data is still recorded and graphed.

Type: Select from Custom, FS-B100, FS-B125, FS-B150, FS-B200, FS-B250, FS-B15, FS-10, FS-15, FS-20, FS-30, FS-40, FS-60, FS-150, FS-200, FS-300, and FS-400.







K-factor: The number of pulses generated in a flow meter used to calculate volumetric throughput.

Offset: K and Offset together represent a linear scaling of the flow meter revolutions to the flow in the units the customer desires.



The K-Factor and offset numbers are automatically adjusted for all available flow sensors except the Custom setting. See **Appendix B: Flow Meters** for K-factor and Offset numbers for common flow meters with their respective 'K' and Offset settings.

Connection Type: Set **Local** for conventionally-wired flow sensors and **Decoder** for a 2-wire flow decoder.

4.  to enter that field.
 5.  to switch between options.
 6.  to set desired option.
-  Press  or  to the next sensor.

Flow Options

Flow Options establishes flow limits to aid in the detection of possible flow problems.

1.  Flow Options

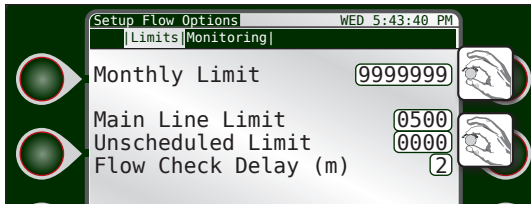

Limits

Monthly Limit: The number, in total gallons, that the irrigation system should not exceed per month. If it does, the DXi controller will either generate an alert (and keep watering) or simply stop watering until a new month begins. Watering can also be resumed by increasing the monthly limit.

Main Line Limit: The number, in gallons per minute, the flow of the main line shall not exceed. If the calculated flow ever does exceed this number, an alert will be triggered condemning all irrigation until cleared. The number should be set to a value *higher* than the flow if all simultaneous stations (six) are “on” but *lower* than if there is a main line break.

Unscheduled Limit: During periods of no programmed irrigation activity or no manually activated irrigation, the flow in a system should be zero. The Unscheduled Limit number, then, is the number in gallons per minute set to trip an alert if flow is detected during these times of inactivity, condemning all automatic irrigation until cleared.

Unscheduled flow conditions may be due to broken water lines, defective valves, faulty solenoids, and/or more.

Flow Check Delay: When a valve is activated, the initial flow rate may be significantly higher than the valve’s “steady” state. This could be due to drainage of water lines, waiting for pump water, or other. The initial high flow rate could therefore trigger many unwanted and premature alerts. This Flow Check Delay delays the calculation of flow for a period of two to nine minutes to allow the flow to stabilize.

To set this number accurately, observe which station takes the longest time for its GPM rate to stabilize. Round this time period to the next minute and use that rounded value as the Flow Check Delay value

 Press  or  to get to “Monitoring” Flow Options.

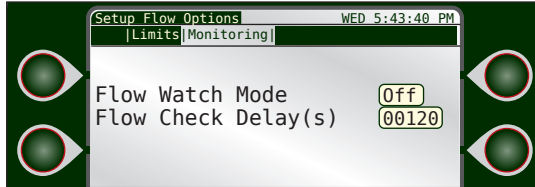

Monitoring Flow

Once the station flow limits have been established, the flow limit checking (upper and lower limits) may be enabled or disabled. When upper limits have been enabled, all station upper limits will be enforced on an individual station basis. When lower limits have been enabled, all station lower limits will be enforced on an individual station basis.



The default is disabled, meaning no limit checking is performed. However, the GPM flow and total monthly flow are still calculated. Monthly limit, main line limit, unscheduled flow, and flow check delay are always enforced regardless of the flow limit monitoring settings.

To Enable Max and/or Min Flow Limit Monitoring:

- 1)  to switch between the check boxes.
- 2)  to turn on or off desired option.

Learn Flow/Current

For the DXi controller to issue meaningful alerts when there is a flow or current problem, the proper flow and current rates must be “learned” by the system. The Learn Flow/Current command therefore teaches the DXi system the nominal (ideal) current and flow settings to each valve and station. One would typically activate the Learn command for either a new system or when a when a new flow meter has been installed.

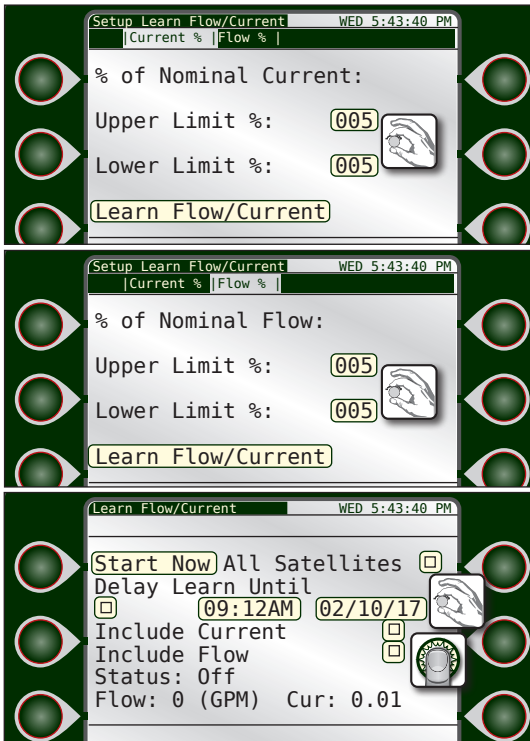

The Learn Flow/Current command consists of three screens:

Current %'s: Setup the Nominal Current limits. Use the Control Dial to switch between and adjust the Upper and Lower Limit fields. Recommended value for Upper Limit and Lower Limit is 30% for both.



Flow %'s: Setup the Nominal Flow limits. Use the Control Dial to switch between and adjust the Upper and Lower Limit fields. Recommended value for Upper Limit and Lower Limit is 20% for both.

Use the Control Dial to activate the **Learn Flow/Current** command, triggering the 3rd screen above.



If the “All Satellites” check box is checked, the learn function will be performed on the submaster and all connected satellites.

On the 3rd screen, two things:

-  If your new system does *not* have a flow meter installed, be sure the **Include Flow** checkbox is blank.
-  If you are running the Learn Flow/Current command due to a new flow meter being installed, be sure the **Include Current** checkbox is blank.

Omit by Date



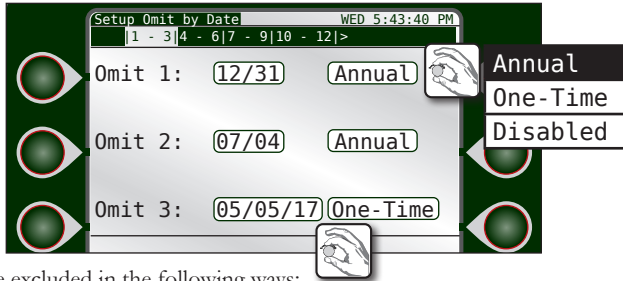





The DXi allows up to 48 days to be excluded from irrigation per year.



Dates can be excluded in the following ways:

- annual** - the exclusion occurs once per year, every year
- one-time** - the exclusion occurs only on the date specified
- disabled** - the excluded date is *not* excluded

Steps

- 1)  **Omit by Date**
 - 2)  to navigate to field to set. Fields that can be changed are: month, date, year (if not “Annual”), and the omit type.
 - 3)  to enter selected field.
 - 4)  to switch between options.
 - 5)  to set desired option.
 - 6) Repeat steps 1 - 4 for all days to omit.
-  Press  or  to get to the next group of Omit Days.

Communication

Submaster

If the Submaster option is active, that means the DXi controller has a direct link to the Central computer. The controller can communicate with the Central in any one of five methods:

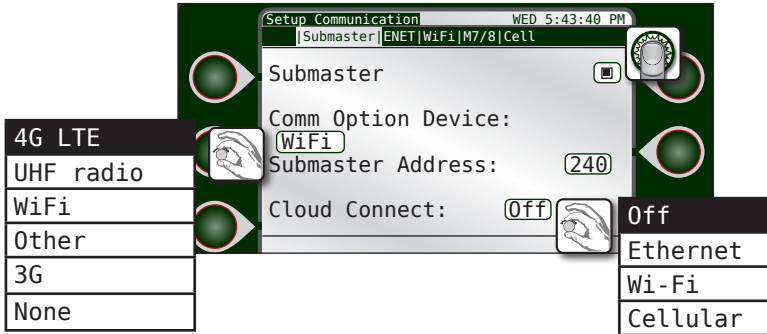

- 4G LTE
- UHF radio
- Wifi
- 3G
- Other

If a device is detected, the controller will set this option.

The **Submaster Address** can be any number between 0 and 999. If you were to have more than one DXi controller as a Submaster attached to any one Central computer, be sure they have different Submaster addresses.

Use the Control Dial to activate, select a communication method, and assign an address for these fields.

Press  or  to get to "Ethernet" screen.

Cloud Connect

The Toro DXi product line provides “Cloud Connect” capability. With Cloud Connect, users will have access to the ProMax Connect™ mobile app to enhance their onsite maintenance experience. In addition, Cloud Connect provides users with enhanced diagnostics and Toro customer support. A DXi controller must use Ethernet, Cellular or WiFi communication to utilize the DXi Cloud Connect capability.

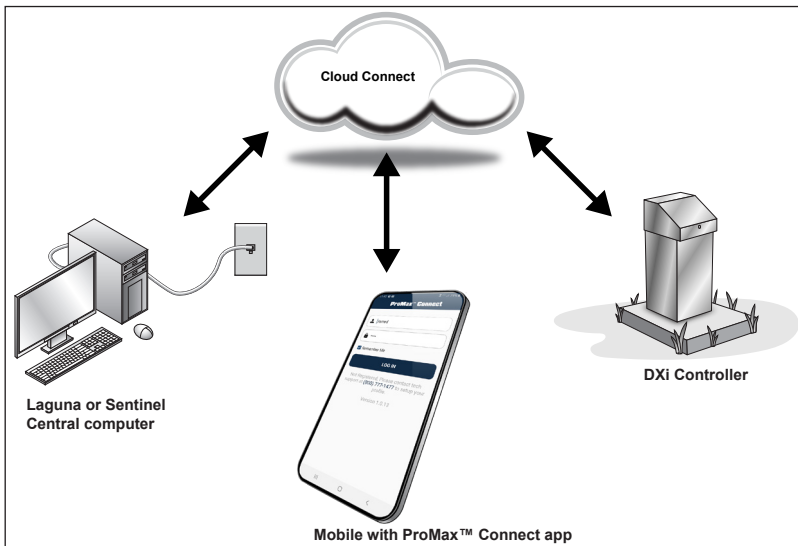

Cloud Connect utilizes a cloud server to bridge communication between the controller in the field and the user. Users can access the controller via Laguna™ central software or the ProMax Connect app.

Cloud Connect Port Settings

For controllers that are connected via Ethernet or WiFi, all communication between the DXi controller and Laguna central software is routed through the Toro cloud server. Network security is maintained by limiting inbound and outbound access to a known URL and port. Network administrators should ensure that firewall settings do not prevent use of the following:

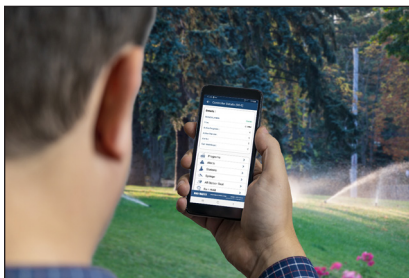

- Outbound Ports 5101-5108 for inbound and outbound from the DXi controller to the Rain Master cloud server, URL: DX3.cloudconnect.rainmaster.com
- Outbound Port 10001 for inbound and outbound from Laguna central software to the Rain Master cloud server, URL: laguna.cloudconnect.rainmaster.com

Ethernet

For Ethernet connectivity configuration, it is necessary to set the Laguna port and whether to use DHCP for TCP/IP settings.

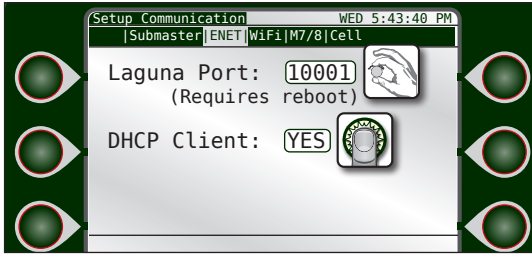

The Laguna ports defaults to 10001. If a separate WLAN port is necessary, use a port dedicated exclusively for LAGUNA (a rare-use case).

Most networks today use DHCP client. Set the DHCP Client setting to YES.

WiFi

The Toro DXi product line provides a WiFi option for communication to Laguna central software. The WiFi option allows for bi-directional communication from irrigation controllers to Laguna central software. WiFi offers advantages over traditional UHF radio networks including faster data rates, no FCC licensing requirement, data security, and availability of 3rd party tools for range-testing and signal strength. (Cellular communication offers the same advantages as WiFi over radio but has fees associated with data usage.)

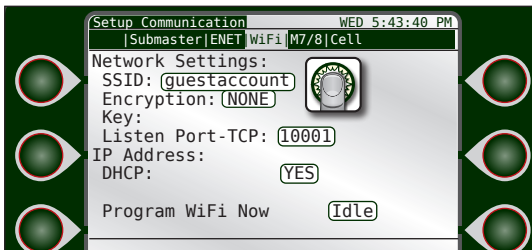

WiFi Setup

Connecting the DXi WiFi module to a wireless network requires the same steps as any wireless network device, such as, selection of the network, network password and password encryption type

The WiFi menu is used to select the wireless network to connect to (SSID). Enter the network password (KEY) and select the password encryption type (Encryption).



The controller does not have the ability to scan for available WiFi networks; the WiFi network name must be entered in manually (case sensitive).



When inputting SSID or KEY, a user can select uppercase, lowercase, numbers or characters by scrolling the wheel.



Pressing the 'B' button will "close out" the edit at the cursor position, deleting any characters to the right of the cursor.

Once all fields have been updated, select 'Program WiFi Now' to save settings to the WiFi communication modules memory.

When complete the field will update to 'complete'.

Changing Frequency on an M7/M8 Radio

1. Push Enter (Control Dial) to get into the sub menu.
2. Press the Setup key, then the Communications key.
3. Scroll or tab over to the M7/8 tab.
4. Highlight the frequencies to be changed and hit Enter. Use the Control Dial to change each number of the frequency. Hit Enter when done setting each number.
5. Select either M7 or M8 by highlighting and hitting Enter.
6. Scroll down to Program Radio Now and hit Enter.

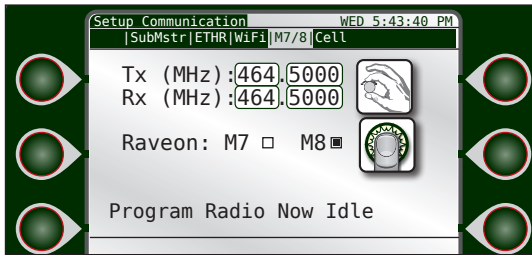

The M7 radio is used in the Base Station connected to the central computer.
The M8 is the radio mounted inside an irrigation satellite.

Cell

The Cell page provides two troubleshooting functions that can be used if the controller disconnects and fails to reconnect to the cloud. Listen ports are for advanced configurations and should only be changed/modified a qualified Toro service professional.

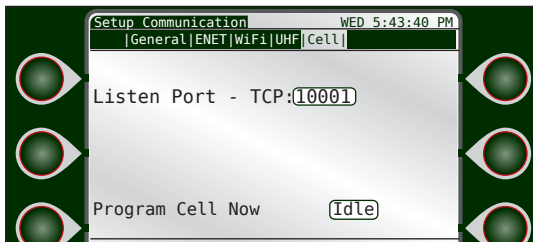

Current Checks

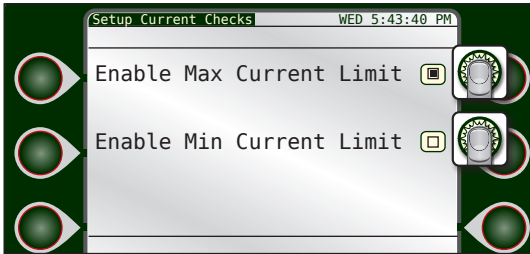

The DXi controller allows the operator to limit and view the controller's output current (Amps) usage. Much like established flow limits aid in the detection of problems with the system, establishing current limits aids in detection of field wiring problems associated with any station. Monitoring features include:

- Display of the total, instantaneous current on a per station basis
- Automatic termination of station output and reporting of station status when the preset maximum current is exceeded
- Automatic termination of station output and reporting of station status when current stays below the pre-set minimum
- Review of station status reports via the Warning/Alarm display
- Automatic current limit setup.



For a complete explanation on current monitoring, please see **Appendix C: Current Monitor**.

To Enable Max and/or Min Current Limit Checking:





- 1)  to switch between the check boxes.
- 2)  to turn on or off desired option.

 Current limits can be set manually (**Stations-->Current**) or "learned" (**Setup-->Learn Flow/Current**).

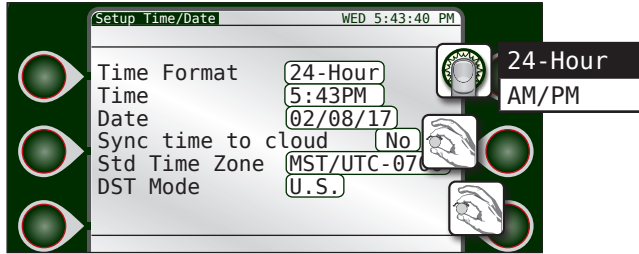
Time/Date

The date and time can be set at any time on the DXi controller.



- 1)  to switch between fields.
- 2)  to enter highlighted field.
- 3)  to adjust values in that field.
- 4)  to set desired option.
- 5) Repeat steps 1-4 as needed.

Firmware Update

Toro continually strives to enhance the performance and functionality of its controllers. Occasionally, a firmware update might be necessary for your controller.

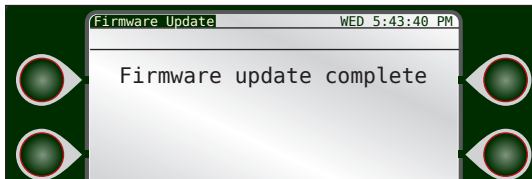

Steps

1. Download the latest firmware driver from Toro's website. Copy file to root drive on a USB drive in folder labeled "FirmwareUpdate". Be sure your DXi controller is on.
2. Accessing the TM from the bottom, insert the USB thumb drive with the latest firmware update on it into the USB slot.
3. The controller will display a message and beep to let you know it has detected a USB thumb drive.
4. Navigate to **Setup** --> **Page 2** --> **Firmware Update**. .
5. The DXi will update the firmware. Once complete, the DXi will display reset.
6. Remove the USB thumb drive.



An instructional video on how to update firmware is located on the Toro website, www.rainmaster.com.

FLOW MAX

FLOW MAX is software that allows the DXi to intelligently share resources and manage operations for satellites using a single point of connection. The shared resources may include common pumps, master valves, and/or flow meters.

A FLOW MAX system is comprised of a number of DXi controllers (typically 3 to 5) with the first controller set up as the submaster. The remaining satellites are set up as slaves.

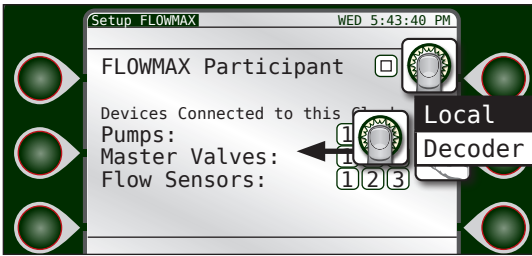

FLOW MAX provides a means to detect station flow limits and main line breaks within design and programming parameters. All controllers participating within a FLOW MAX system must be programmed as participants from each of their respective control panels.

In order for flow volumetric totals to be tracked/logged at the controller and in Laguna central software, the selection must be made under "Devices connected to this Clock" for the flow sensor point of connection.

Please see **Appendix D: Setting Up a FLOW MAX System** for a complete explanation on FLOW MAX and setting up a FLOW MAX system.

Station Count

It is required to manually change the station count. The station count variable dictates how many stations participate in the Learn Current/Flow events. If the wrong number of stations are entered, the Learn Current and Learn Flow events do not operate correctly. If the station count is set higher than the number of local stations actually connected, the balance will be addressed as 2-wire stations.

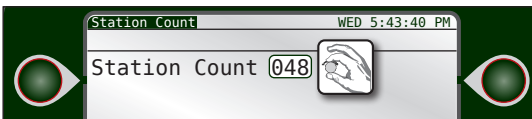

Master Valves & Pumps

This screen allows the operator to setup up current limits for the master valves and pumps that can be connected to the DXi controller.

The master valve can be set as either Normally Closed (N.CL.) or Normally Open (N.OP.)

It is also possible to have the DXi controller "learn" the different current settings for the MV or pump installed.

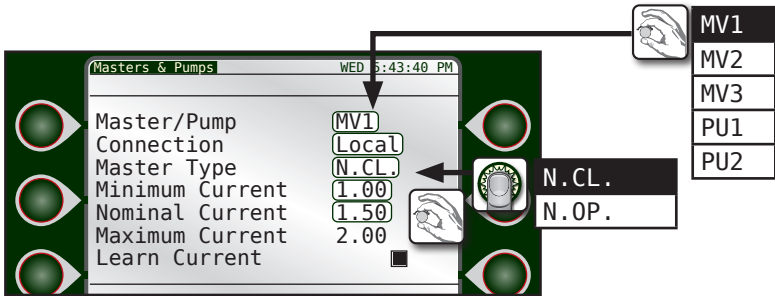

Connection

Used to distinguish between a 2-Wire or conventional MV / Pump.



Program Decoder

This screen allows the operator to program any decoder plugged into the Programmer port of the 2-wire card for the DXi controller.

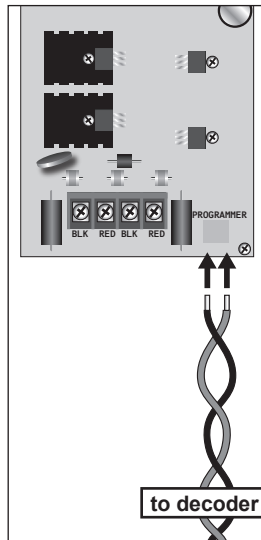
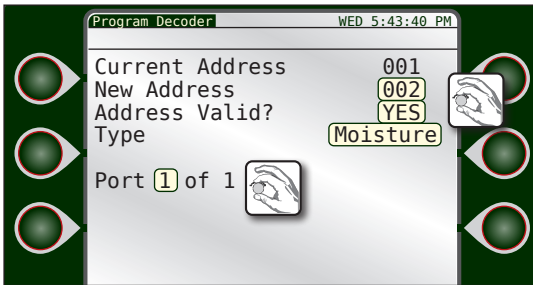
1. Connect the desired decoder. The DXi will read the current address and the type of decoder (station, flow, or moisture) and display that information.



2. In the New Address field, change the value to desired address. Push Control Dial to enter.
3. Be sure to mark the decoder with its new address.

-  A station decoder address is its station number.
-  A station decoder cannot use the same state address/number as a conventional station.
-  Valid station decoder/address range is 1 - 200.

Fixed address ranges are used for MVs / Pumps.

Master Valves 1 - 3 and Pumps 1 - 2 use the following fixed addresses:

MV1 = 201	Pump 1 = 204
MV2 = 202	Pump 2 = 205
MV3 = 203	

Moisture decoders are addressed 1 - 16 based on the irrigation program to which they are assigned to monitor. For example, moisture decoder 2 will monitor irrigation program 2.



Flow decoders are addressed 1 - 3 based on the flow sensor number. For example, flow decoder 3 will be assigned to flow meter 3.

For more information on 2-wire decoders, see **Appendix D**.

Chapter 5: Program Entry

The DXi controller allows the user to program irrigation schedules for up to sixteen programs. For an irrigation program to be considered valid, it must contain:

- at least one start time
- at least one active irrigation day
- at least one station assigned to the program
- and a run time assigned to each station

 Press  or  to get to Page 2 of Program Menu.

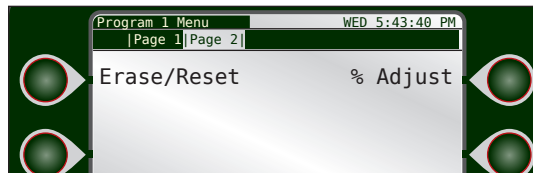
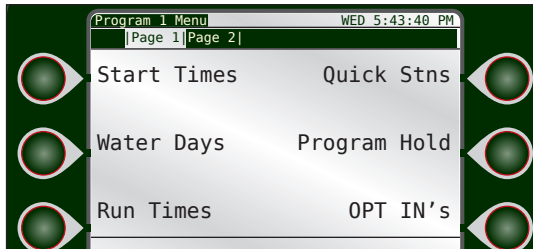

Second screen of Program 1 Setup

Start Times

The DXi controller is capable of handling 12 start times per program. The Start Time is defined as the precise time of day that a given irrigation or auxiliary program begins.

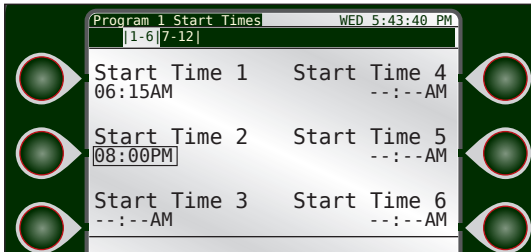

The procedure to set Start Times was covered in **Chapter 3: Quick Start**.



Be sure that a program's Start Time does not conflict with the previous program's Run Time. If there is overlap, the second start time will be skipped and irrigation will not occur.

Water Days

The DXi controller offers three modes with which to create an irrigation schedule.

- **14-day:** Create an irrigation schedule over a two-week water cycle.
- **31-day:** Create an irrigation schedule over a 31-day water cycle.
- **Interval:** Create an irrigation schedule with a specified number of days between irrigation.

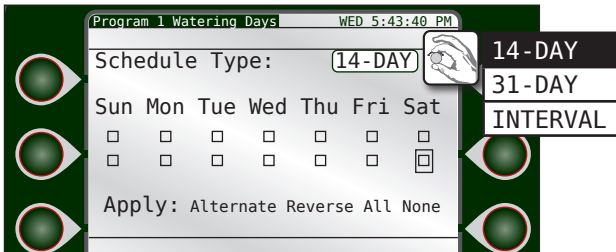

Using the Control Dial, operators can individually assign active irrigation days within the 14-day or 31-day time frame. Operators can also select **Alternate** or **Reverse** for quick assignment of irrigation days.

The procedure to set Water Days was covered in **Chapter 3: Quick Start**.

Run Times

The DXi controller allows the user to individually set a run time for each station. The procedure to set Run Times was covered in **Chapter 3: Quick Start**.

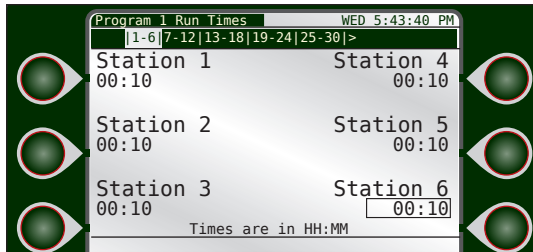

To switch between entering run times in hours:minutes vs minutes:seconds, see OPT INs, page 43.







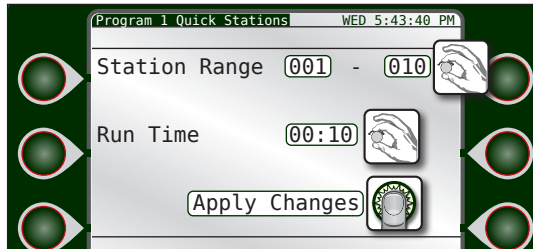





Quick Stations

Quick Stations allow the user to quickly enter a run time for a range of stations instead of individually assigning them as done in chapter 3.

This is handy for stations that share similar vegetation type and sun exposure.



Steps

1.  to enter the first **Station Range** field.
2.  to change the value of the first station.  to set.
3.  to switch to the second **Station Range** field.  to enter.
4.  to change the value of the second station.  to set.
5.  to switch to the **Run Time** field.  to enter.
6.  to change the run time value.  to set.
7.  to switch to the **Apply Changes** field.
8.  to execute.

Program Hold

A Program Hold can be set, suspending all irrigation activity *for that program only* for the specified number of days or until manually canceled.

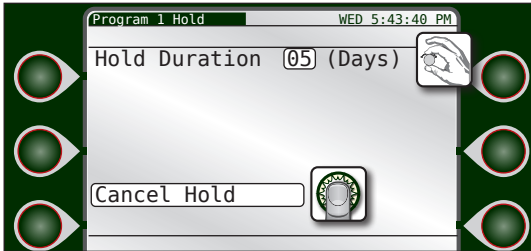

 Actively setting a Program Hold for a program will cancel all activity for that program, including non-irrigation activity (see OPT INs next page).



 To set a Program Hold for **all** irrigation programs, do so from the Main Menu screen utilizing the Rain Hold feature.

The procedure to set a Program Hold was covered in **Chapter 3: Quick Start**.

To Cancel a Program Hold

- 1)  so that the **Cancel Program Hold** field is highlighted (see above).
- 2)  to cancel.

OPT INs

OPT INs essentially tells the DXi controller to include a Pump or Master Valve in irrigation operation.

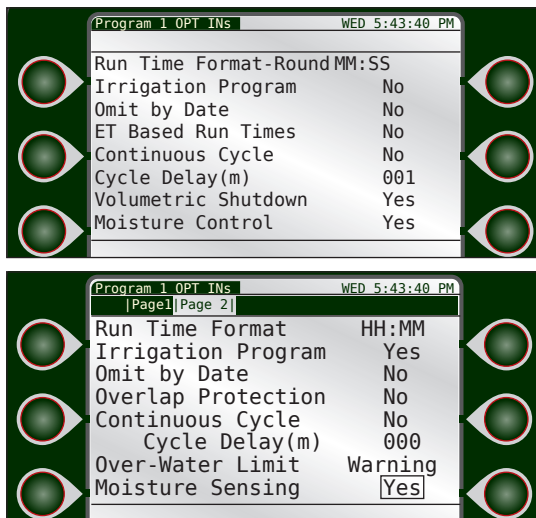

Pumps: Check the physical connections on the main DXi board to determine what numbers to opt in for installed pump/s (if any).

Master Valves: Check the physical connections on the main DXi board to determine what numbers to opt in for installed master valves/s (if any).

MV/P Start Delay (sec): This is the amount of time, in seconds, that the Master Valve and Pump will wait after a Program's start time before operating. The reason for this is to make sure irrigation channels are open before water starts being pumped and flowing. A pump can be damaged if it begins pumping with no outlet for the water.

Inter-Station Delay: Yes or No. This is the delay between when one station ends irrigation and the next in the program begins. Setting a delay between stations helps to avoid water hammer.

ISD Delay (sec): This is the length of the Inter-Station Delay in seconds.

MV/P Inter-Station: Off or On. Allows a user to select if a MV/Pump is activated in-between station activations in a program. If an operator has opted to use an Inter-Station Delay of thirty seconds, for example, then he/she might want the pump and master valve to stop working during that delay.

Run Time Format: Allows the user to switch between entering station run times in hours:minutes and minutes:seconds. The runtime format is displayed on the run time screen (see page 41).

Irrigation Program: Yes or No. Defines if the program is a program that runs irrigation (sprinklers, sprays, rotors, etc.) or a non-irrigation program used to control non-irrigation items (lighting, fountain, etc.).



Rain Hold events will only suspend operation of irrigation programs and not non-irrigation programs. Non-irrigation programs will also not be effected by Flow related alarms such as: Main Line Limit, Unsheduled Flow, Monthly Water Limit, or station flow alarms.

Omit by Date: Yes or No.

If set to Yes, the specified program will not irrigate on days set under the Omit by Date/s command, under Setup-->Omit by Date.

If set to No, any and all Omit by Date/s will be ignored.

Overlap Protection: Yes or No. Overlap protection prevents programs from running on top of each other. This is handy to prevent too many stations from activating at once and also to prevent two programs activating the same station at the same time.

Continuous Cycle: Yes or No. Continuous Cycle runs an irrigation program over and over again during a user-defined Cycle Start and End time. The **Cycle Delay** is how long the cycle waits, in minutes, before starting again. It is similar to setting Cycle and Soak for an individual station, but for an entire program.



If Continuous Cycle is turned on for a program, it is necessary to go back to the program's Start Times and define the Cycle Start and Cycle End times.

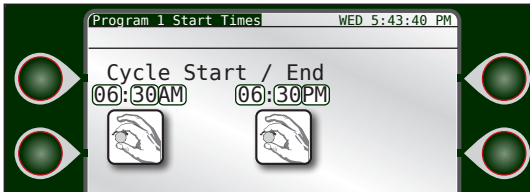

A twelve hour water window defined during which Program 1 will run over and over.

Over-Water Limit: Warning or Stop. If the monthly irrigation limit is exceeded, this option determines if the DXi controller generates an alert (but keeps irrigating) or stops watering completely.

Moisture Sensing: Yes or No. Moisture sensing enables data logging and collection of moisture data. For complete installation and setup instructions for a moisture sensor, please see Toro document 373-1021, TW-DAC-SOIL Moisture Sensor Installation Guide.

Establishment Programs

Programs 15E and 16E are designated establishment programs that expire after a user defined duration. Establishment programs are used for growing seed, when frequent watering is needed at first but not after maturity.

Establishment programs are setup the same as a traditional program, except the establishment start and end dates must be defined.

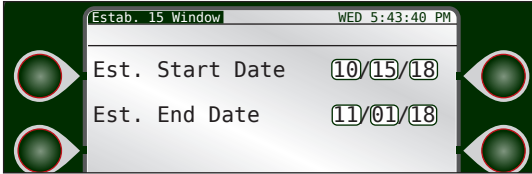





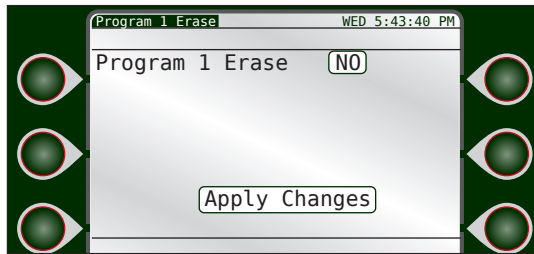

Erase/Reset

To Erase a Program

1.  to Program Menu Page 2.



2.  to YES/NO field.  to enter.
3.  to change to YES.  to set.
4.  to Apply Changes field.  to set.

% Adjust

Setting the % Adjust Value field affects irrigation only for that specific program. For example, if you set a % Adjust value of 50% for Program 1, run times that are set to 20 minutes will only run for ten. Program 2 run times will be unaffected.

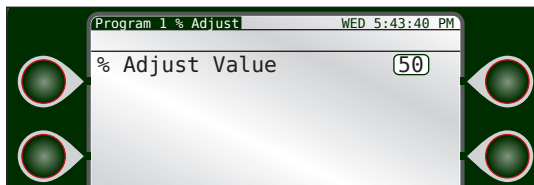

If you set the % Adjust value to 150% for Program 2, run times set for 20 minutes will now run for 30. Program 1 run times will be unaffected.

The procedure to set % Adjust was covered in **Chapter 3: Quick Start**.

Backup Programs 10 & 11

Programs 10 and 11 are utilized as backup irrigation programs when using Laguna central software Advanced Irrigation Management (AIM) or Advanced ET generated Independent Station Control (ISC) algorithms. If an ISC fails to download from central to the controller for more than 24 hours, the controller will run the backup programs irrigation schedules.

It is strongly recommended to utilize Backup programs when using AIM or Advanced ET generated ISCs in order to maintain any Master Valve or Pump association to a station.



Programs 10 & 11 serve as conventional programs if not using AIM or Advanced ET generated ISCs.

Chapter 6: Stations

The Stations command allows the user to:

- define minimal, nominal, and maximum flow and current amounts for every station in a system
- set parameters for Cycle and Soak to reduce water runoff.

Flow

This screen allows the operator to manually set the minimal, nominal, and maximum flow amounts for every station in a system.

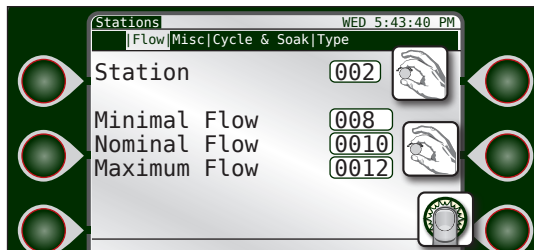

The operator can manually set the minimal, nominal, and maximum settings for each station, or simply check the **Learn Flow** checkbox at the bottom of the screen. When the Learn Flow/Current command (chapter 5) is activated, the fields for those stations will be filled in automatically.

Current

This screen allows the operator to manually set the minimal, nominal, and maximum current amounts for every station in a system.

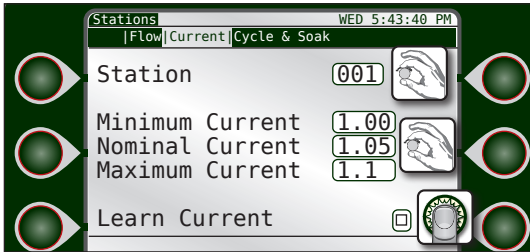

The operator can manually set the minimal, nominal, and maximum settings for each station, or simply check the **Learn Current** checkbox at the bottom of the screen. When the Learn Flow/Current command (chapter 5) is activated, the fields for those stations will be filled in automatically.

Cycle & Soak

Cycle and Soak was developed as a method to ensure the soil absorbs as much of the irrigation water as possible, minimizing water run-off.

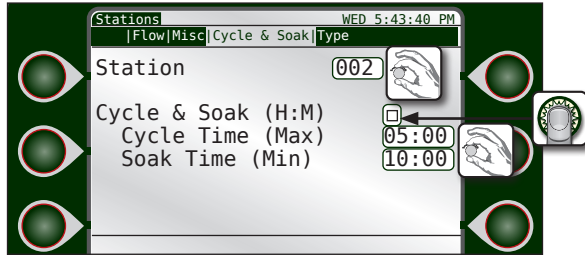

Imagine the run time for station 2 is fifteen minutes. However, station 2 irrigates a slope with a walkway at the bottom. If the station irrigates for fifteen minutes straight, most of that water will simply run off the hill and onto the hardscape and be lost. Cycle and Soak is a way to eliminate or drastically reduce that waste.

Cycle Time (Max) - This is how long the station will run in “chunks” towards the overall run time. If station 2 run time is 15 minutes, then, according to the settings above, station 2 will irrigate for 5 minute "chunks" until that run time is met.







Soak Time (Min) - Between those irrigation cycles is the soak time in which no irrigation takes place. Water is allowed to absorb into the soil. After the specified “soak” time, irrigation will resume for another Cycle Time or until the station run time is met.



Soak time may be longer than the minimum time specified.

A DXi will execute irrigation for other stations in a program during a soak time, instead of waiting idle, in order to optimize a user's water window.

Steps

- 1)  to select the desired station.  to set.
- 2) Turn on Cycle & Soak for that station by .
- 3)  to adjust Cycle Time.  to set.
- 4)  to adjust Soak Time.  to set.

Chapter 7: Reports and Diagnostics

Reports

The DXi controller can generate three types of reports: controller events, water usage, and soil sensor status.

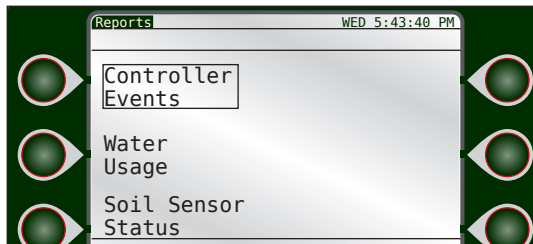

Controller Events

Controller Event reports show controller information such as station start and stop times, station duration, and more. The information displayed will be similar to the information displayed in the Laguna central software, **Reports -> Irrigation Statistics** reports.

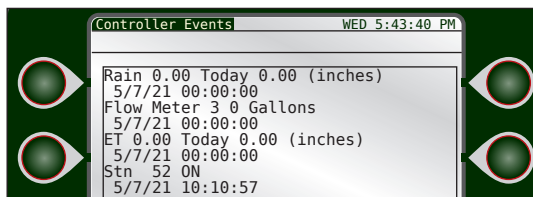

Water Usage

The Water Usage report contains statistics on monthly water usage. This report can also compare current usage to the previous year.

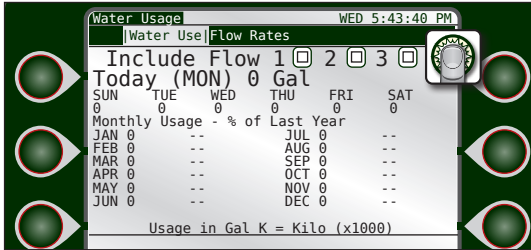

It is possible to view water usage by individual flow meter, all three, or any combination thereof.

 *Water usage flow totals are calculated and populated at 12:00 am, each day.*

Flow Rates

The Flow Rates screen contains real-time flow rate information for the (up to) three flow sensors attached to the DXi controller.

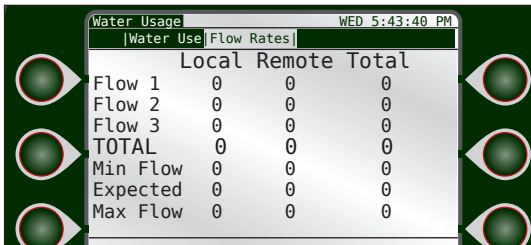

Any flow read via a controller's local flow input1, flow input2, or flow input3 will be displayed under local flow.

Any flow read via a downstream/upstream FLOWMAX participating controller's local flow input1, flow input2, or flow input3 will be displayed under remote flow, if the downstream/upstream satellite specifies the flow sources point of connection.'

Soil Sensor Status

The Soil Sensor Status report contains information about soil sensor statistics.

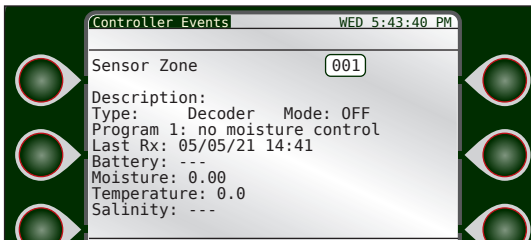

Diagnostics - General

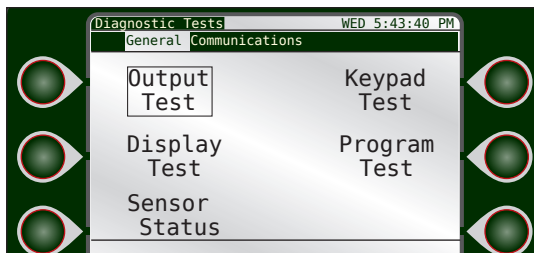

Output Test

The Output Test verifies controller output functionality. Use the Control Dial to set the range of stations to test, adjust the duration (test time per station), and to manually start and, if desired, stop the test.

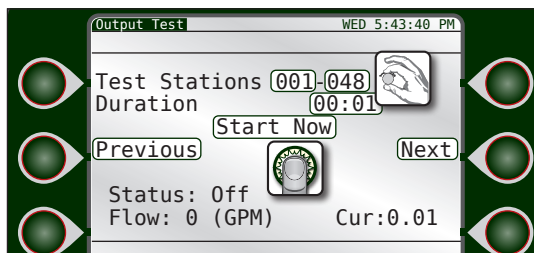

The DXi controller will display flow and current information as it cycles through the stations.

Sensor Status

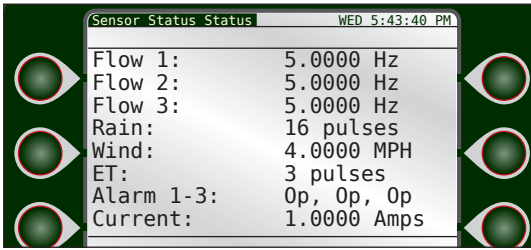

The Sensor Status test displays critical information about each device attached to the system.

Program Test

The Program Test turns on every station within a particular program for the specified Duration (minutes: seconds).

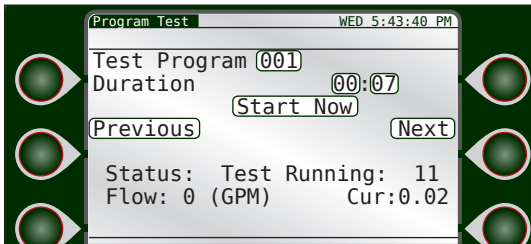

to select a Program to test.



to set the duration for each station of the program in the test.



Start Now to start the Program test.



Previous to test the previous station again.



Next to switch to the next station in the program.



Associated MV's or Pumps will not be activated during Program Test.

Display Test

The Display Test turns on ever pixel on the display to ensure every pixel is functioning.

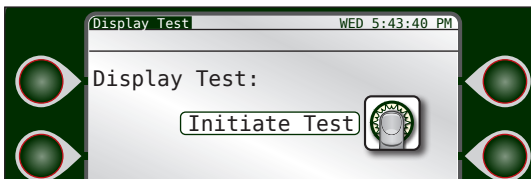

Keypad Test

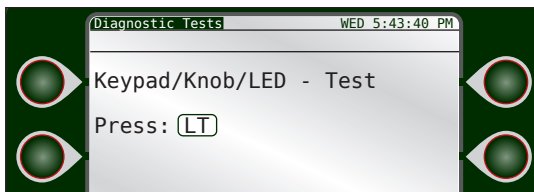

The Keypad Test is to confirm the buttons and Control Dial on the faceplate are functioning properly. The test prompts the user to press each button as directed.

To bypass the test, touch nothing and the test will cancel within five to ten seconds.

Diagnostics - Communications

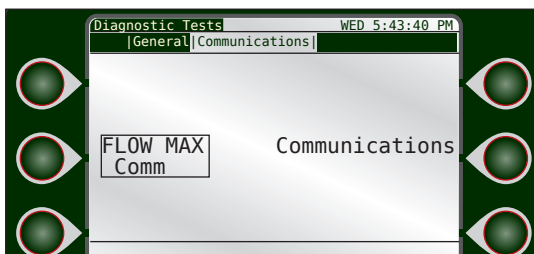

Second screen of Diagnostics

FLOWMAX Communications

FLOWMAX Communications diagnostics screen displays communication information between the submaster and satellites in the FLOWMAX group.

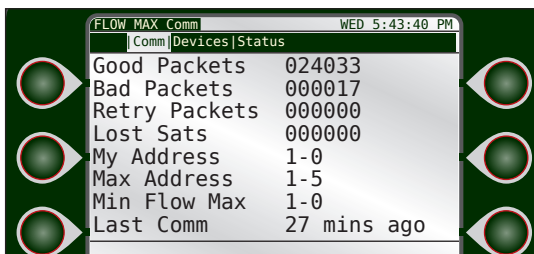

FLOWMAX Devices

FLOWMAX Devices diagnostics screen displays gallons per minute flow information for any and all attached flow sensors and devices. Additionally, the operator can quickly see how many master valves and/or pumps are active to the system, and if the point of connection is at the submaster or satellite.

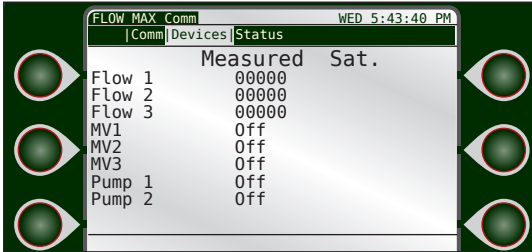

FLOWMAX Status

FLOWMAX Status diagnostics screen displays all the possible reasons irrigation activity could be suspended and whether or not that reason does trigger such a suspension.

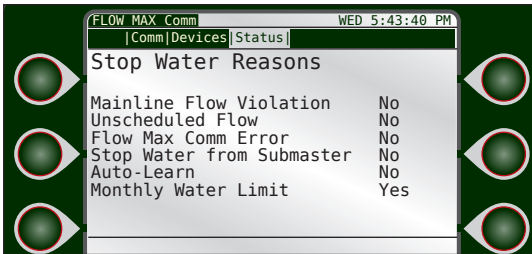

Communications

ENET

The TCP/IP diagnostic screen displays TCP/IP configuration information, including your controller's IP address, DNS, NetMask, and Gateway.

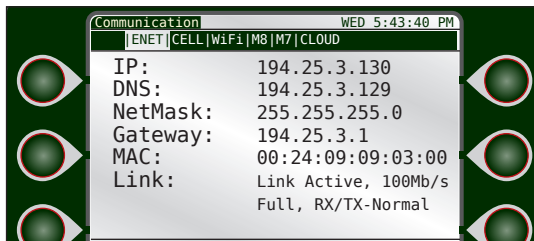

Ethernet link status is a handy tool to determine whether you have a valid network connection or not.

CELL

The Cellular diagnostic screen displays cellular configuration information.

Select the **Refresh Status** command to confirm successful cellular communication.

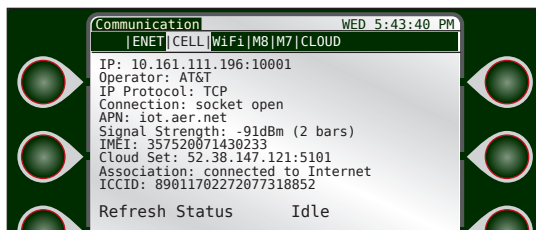

WiFi

The WiFi diagnostic screen displays WiFi configuration information.

Select the **Refresh Status** command to confirm successful WiFi communication.

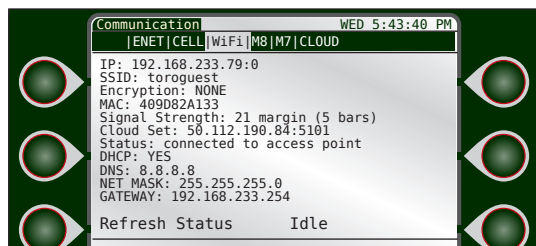

M8

The M8 diagnostic screen displays M8 radio configuration information.

Select the Refresh Status command to confirm successful cloud communication.

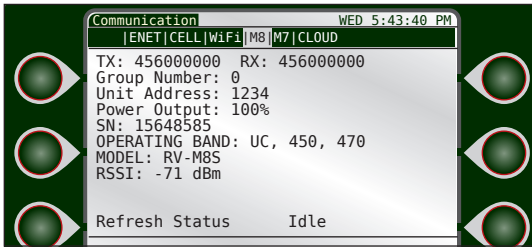

M7

The M7 diagnostic screen displays M7 radio configuration information.

Select the Refresh Status command to confirm successful cloud communication.

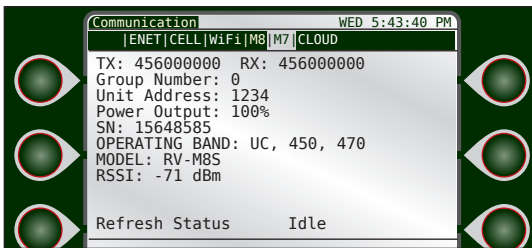

CLOUD

The CLOUD diagnostic screen displays Toro cloud configuration information.

Select the Refresh Status command to confirm successful cloud communication.

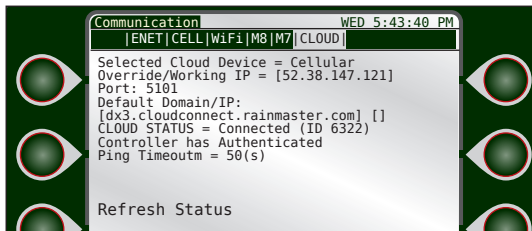

Chapter 8: Alerts

The DXi series controller automatically alerts the operator when problems occur or certain conditions arise. The controller may trigger an alert in response to over 11 different conditions. Each condition is date/time stamped and includes additional information which may be helpful in troubleshooting the problem. Up to 100 alerts may be saved in the controller at one time. The user may delete alerts at any time.

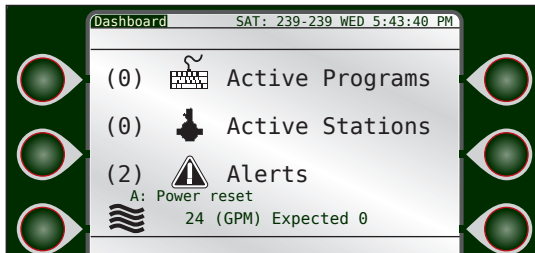

Some alerts, such as a main line limit violation, require immediate attention as all irrigation activity is condemned until the alarm is cleared.

Most alerts, due to the controller's programming, do not necessitate immediate operator attention. For example, consider a station with a broken head (FLOW UPPER LIMIT warning). Upon detection of this failure, the DXi controller will:

1. Turn the failed station off.
2. Mark the station as condemned (will not water again until the alarm/warning is cleared).
3. Advance to the next scheduled station in the program.
4. Report the failed station as a warning.

Upon review of the alert, maintenance personnel would repair the problem and then clear the alert at the controller. (Clearing the alert re-enables all irrigation at the station).

Any time an alert is triggered, the DXi screen displays the alert type.

Analyzing an Alert

Alerts can be accessed for analysis from the Main Menu.

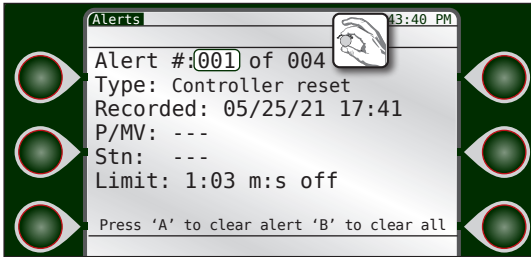

Alert #: Displays the alert number out of the total number of alerts.



to cycle through the alerts.

Type: There are eleven different types of alerts. See **Alert List** below.

Recorded: Displays the date and time the alert was triggered.

P/MV: If the alert was related to a pump or master valve, the number of the pump or master valve would be displayed here.

Stn: If the alert was station specific, the number would be displayed here.

Limit: If the alert was limit related (for example, the DXi controller measured a low flow limit violation), the limit field would display the lower limit value and the measured flow value.

Clearing Alerts

1.  to scroll through alerts.



to clear an alert.



To quickly clear all alerts, scroll to the last alert logged and clear, this is the alert type 'Clear to Erase All Alerts'.

Alert List

Alert	Alert Code (displayed with Laguna central software)
RESET	1101
HIGH TEMPERATURE	1102
STATION COMMUNICATION ERROR	1103
MASTER VALVE HIGH CURRENT	1104
FLOW LOWER LIMIT	1105
FLOW UPPER LIMIT	1106
WATER LIMIT	1107
MAX STATION LIMIT	1108
START DELAY OVERLAP PROTECTION	1109
START BLOCK MAX STATIONS	1110
START BLOCK PROGRAM RUNNING	1111
SATELLITE OFFLINE	1112
SATELLITE ONLINE	1113
HW COMM FAIL	1114
FM COMM FAIL	1115
FM STOP WATER	1116
FM MULTIPLE FLOW METERS	1117
FM MULTIPLE PUMPS	1118
FM MULTIPLE MASTER VALVES	1119
CURRENT_UPPER_LIMIT (Maximum)	1120
CURRENT_LOWER_LIMIT (Minimum)	1121
MAIN_FLOW_LIMIT	1122
UNSCHEDULED_FLOW_LIMIT	1123
STATION_SHORT_CIRCUIT	1124
AUTO_LIMITS_ABORTED	1125
Flow Max Communication Restored	1126
Flow Max Station Advance	1127
Power ON	1128
DAILY_RAIN_LIMIT	1129
HOURLY_RAIN_LIMIT	1130
WIND_EXIT_CONDITION	1131
WIND_ENTER_CONDITION	1132
UPLOAD_REQUEST	1133
CLEAR_ALL_ALERTS	1134
STATION_OPEN_CIRCUIT	1135
STATION_OVER_CURRENT	1136
DECODER_PORTS_EXCEEDED	1137
DECODER_NO_AC_VOLTAGE	1138
MV CURRENT UPPER LIMIT	1139
MV CURRENT LOWER LIMIT	1140
PUMP CURRENT UPPER LIMIT	1141
PUMP CURRENT LOWER LIMIT	1142
FLOW MAX LOWER LIMIT (Submaster only)	1143
FLOW MAX UPPER LIMIT (Submaster only)	1144

These alerts and any corrective action to end the alert condition are explained in full below.

Alerts and Corrective Action



For all alerts, upon resolution of the specific problem, be sure to CLEAR all alerts at the controller.

Reset

Reset alerts are triggered by the controller restarting due to either:

1. a power reset
2. a request by the user or firmware to restart

Clear the alert at the **Setup** - -> **Alerts** screen.

High Temperature

This alert is triggered when the main board temperature sensor exceeds a threshold value.

Station Communication Error

This alert is triggered when communication fails between the TM and the specific station output board terminal.

Master Valve High Current

The controller expects a certain current delivered to the Master Valve to trigger operation. If the measured current is greater than the expected current, within the preset tolerances, a High Current alert will be triggered.

Flow Lower Limit and Flow Upper Limit

The Flow Lower Limit and Flow Upper Limit alerts are triggered when the measured flow is either less than or greater than the expected flow, + or - preset tolerances. Both alerts display the station number (**Stn:**) which was on at the time of the limit violation, the Master Valve (MV1) and/or the Pump, the GPM reading (12) as measured by the flow meter, and the limit value set for the station. Upon detection, the controller automatically terminates irrigation on the station and advances to the next station in the program. Condemned stations will not irrigate again until the warning has been cleared.

Flow Lower Limit alert may be caused by:

- A malfunctioning valve
- Incorrectly established individual station limits
- Large variations in static water pressure
- Improper regulation
- Line impediments

Flow Upper Limit alert may be caused by:

- Stuck valve (from previous station)
- Broken pipes/heads
- Unreasonable or inaccurate individual station limits
- Large variations in system water pressure

Flow Alert Troubleshooting

1. If station limits are suspected, manually turn each station on and observe the nominal GPM readings.
2. Compare the GPM reading with the limit setting to insure that adequate margin exists (typical: 50% below nominal).

Water Limit

The controller has exceeded its monthly watering allocation (set in the Setup-->Flow->Flow Options screen). If the program has been set up to stop watering, no further irrigation will occur until day one of the next month. If the program has been set to provide an alert only, and the alert is cleared, then this alert will reappear (though watering continues).

Corrective Action

The Monthly Limit can be increased.

Max Station Limit

This alert is triggered when the controller has attempted, either through manual operation or scheduled operation, to activate more than sixteen stations at one time.

Corrective Action

1. Try to locate the "overstacked" schedule program.
2. If the alert was triggered by an overstacked manual operation, for example setting too many simultaneous stations to execute at once, there is nothing to be done other than not to exceed the simultaneous station limit again.

Start Delay Overlap Protection

This alert is triggered when the DXi attempts to start a second program when the first program is still active and Overlap Protection (under Program-->OPT INs) is active for that first program.

Start Block Max Stations

This alert is triggered when the DXi controller attempts to operate more than the number of maximum stations at one time.

Start Block Program Running

This alert is triggered when the operator has programmed the DXi controller to start a program that is already running. For example, Program 1 starts at 6am every morning and runs for three hours. At 8am, the operator attempts to manually run Program 1 from the Manual menu. An alert is generated.

Satellite Offline / Online

This alert is triggered when the satellite loses / reestablishes contact with the submaster.

Hardware (HW) Communication Failure

Set on submaster to indicate it lost communication with a satellite **not** configured for Flow Max.

FlowMax (FM) Communication Failure

Set on submaster to indicate it lost communication with a satellite configured for Flow Max.

FlowMax Stop Water

This alert is triggered when the controller is in a stop watering state.

FlowMax Multiple Flow Meters

This alert is triggered when the specified flow meter is defined on more than one controller in the Flow Max group. DXi will add flows together for multiply defined flow meters.

FlowMax Multiple Pumps

This alert is triggered when more than one controller in the flow max group has the specified pump defined. DXi will operate all multiply defined pumps in tandem.

FlowMax Multiple Master Valves

This alert is triggered when more than one controller in the flow max group has the specified master defined. DXi will operate all multiply defined masters in tandem.

Current Upper / Lower Limit

This alert is triggered when actual current was above maximum current or below the minimum current allowed.

Main Flow Limit

This alert is triggered when flow exceeded main line flow limit.

Unscheduled Flow Limit

This alert is triggered when flow exceeded unscheduled flow limit.

Station Short Circuit

This alert is triggered when decoder reports short circuit on initial power up. Short circuit is defined as 1Amp or higher.

Auto Limits Aborted

This alert is triggered when auto limits process was terminated before completion.

FlowMax Communication Restored

Flow Max configured satellite triggers this alert when it has established or restored communication with the Submaster.

FlowMax Station Advance

This alert is triggered when the satellite is a FLOWMAX participant and received station advance from a FLOWMAX related alarm.

Power ON

This alert is triggered when the controller resets and restarts after a power disruption.

Daily / Hourly Rain Limit

This alert is triggered when rain exceeded daily / hourly rain limit.

Wind Exit / Enter Contition

This alert is triggered when wind was below / above limit for prescribed time, wind shutdown is ended / started.

Upload Request

User has indicated they wish controller settings to be uploaded by the central.

Clear All Alerts

Clearing this alert will clear all alerts, and all underlying flags that may have been orphaned if alerts were overwritten.

Station Open Circuit

This alert is triggered when decoder reports open circuit.

Station Over Current

This alert is triggered when decoder reports over current after initial power up. Over current is defined 1Amp or higher.

Decoder Ports Exceeded

This alert is triggered when decoder reports too many ports on.

Decoder No AC Voltage

This alert is triggered when decoder reports no AC voltage.

MV Current Upper Limit

Indicates Master Valve current draw exceeded the maximum allowed. Alert will display the measured current and maximum limit.

MV Current Lower Limit

Indicates Master Valve current draw was below the minimum allowed. Alert will display the measured current and minimum limit.

Pump Current Upper Limit

Indicates Pump current draw exceeded the maximum allowed. Alert will display the measured current and maximum limit.

Pump Current Lower Limit

Indicates Pump current draw was below the minimum allowed. Alert will display the measured current and minimum limit.

FLOW MAX Lower Limit (Submaster Only)

Indicates actual flow was below minimum flow allowed. Alert will display measured flow and lower limit.

FLOW MAX Upper Limit (Submaster Only)

Indicates actual flow was above maximum flow allowed. Alert will display measured flow and upper limit.

Chapter 9: Rain Hold



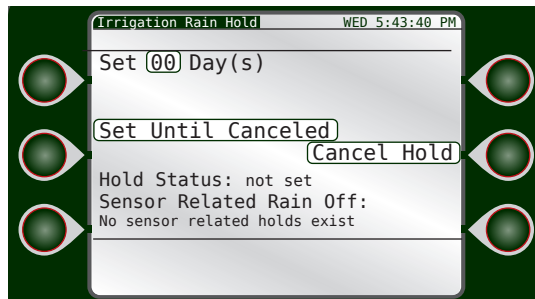

There are several ways in which a DXi can be placed in Rain Hold. This chapter will focus on a globally set Rain Hold. For a local program level Rain Hold, please refer to Chapter 6, Program Hold. A global Rain Hold can be set manually via Main Menu -> Rain Hold. When activated, Irrigation Rain Hold will suspend irrigation activity for the specified number of days (or until canceled).

Additionally, a Rain Hold can be set via a tipping bucket rain sensor, rain switch sensor, freeze switch sensor and/or Laguna central software. A sensor related Rain Hold event will be displayed at the bottom of the screen. For connecting sensors to a DXi controller, see **Appendix B**.





Non-irrigation programs (such as lighting or for a fountain), are NOT placed on a Rain Hold with this command.



To Place a Rain Hold for a specified number of days:

- 1)  Enter **Set Day(s)** field.
- 2)  Change to desired number of days.
- 3)  Set value.
- 4) When done, press .

To Place a Rain Hold for an indefinite period of time:

- 1)  to **Set Until Canceled** field.
- 2)  to activate indefinite rain hold.

To Cancel a Rain Hold

- 1)  to the **Cancel Hold** field.
- 2)  to cancel.



Canceling a Rain Hold here does not cancel a Rain Hold set for an individual program.



*Rain Hold by Program is found under **Chapter 5: Program Entry**.*

Chapter 10: Manual Operation

Operators can manually activate irrigation for a single station, a group of stations, or a program. There are four manual options:

- **Station:** Activate a single, specific station for a specified amount of time.
- **Simultaneous:** Allows an operator to activate multiple stations as they are activated. The DXi can operate sixteen stations simultaneously.
- **Sequence:** Stations can be activated in a non-linear sequence.
- **Program:** Execute the specified program at the specified time.

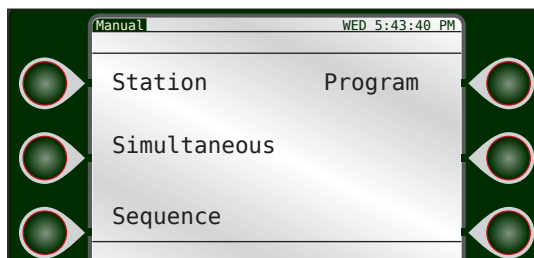

Station

It is possible to manually activate any station within the DXi system.

Master Valves and/or Pumps can be activated independently of stations by selecting station '000' then enabling the desired Master Valves and/or Pumps to active.

The DXi monitors current and--if a flow meter is installed--flow.

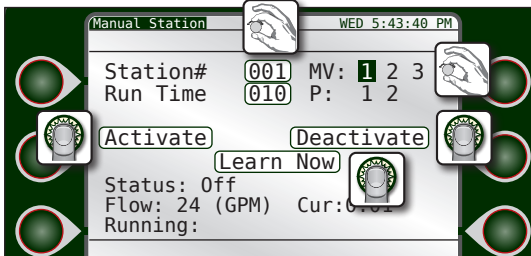

To Activate Manual Station Operation:

- 1) to enter **Station#** field.
- 2) to select desired station. Set it.
- 3) and to enter, adjust, and set Run Time.
- 4) Navigate to the **Activate** field. to begin the manual station. Irrigation will begin immediately.

As stations are activated, the master valve (MV) and/or pump (P) associated with that station will be highlighted, indicating they will activate along with that station. It is possible to manually enable and disable the master valve/s and pump/s, although Toro does NOT recommend that.

To Deactivate Manual Station Operation:

- 1) to **Deactivate** field.
- 2) to deactivate.

Learn Now

The **Learn Now** command can be executed to manually learn flow and current settings for the specified station. Learn Flow and Learn Current must be turned on under **Setup --> Stations --> Flow** and **Current** screens.

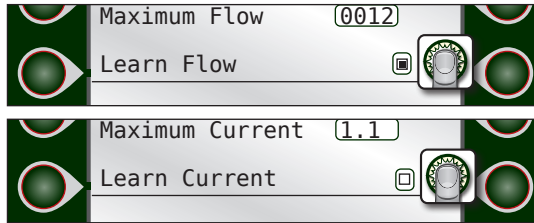





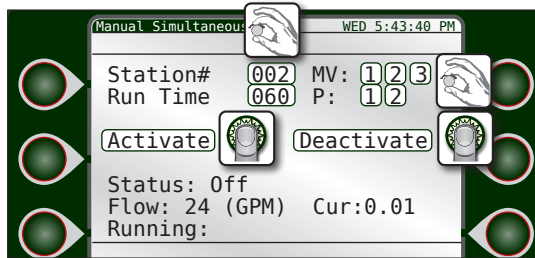

To use the Learn Now function for current measurements, only one station can be activated (as in, no multiple stations, master valves or pumps).

Simultaneous

The DXi controller can operate up to sixteen stations simultaneously. As you activate stations, the DXi monitors flow and current.





To Activate Simultaneous Operation:

- 1)  to enter **Station#** field.
- 2)  to select desired station.  Set it.
- 3)  and  to enter, adjust, and set Run Time.
- 4) Navigate to the **Activate** field.  to begin the manual station. Irrigation will begin immediately.
- 5) User must activate each station, then has the option to activate another. Repeat steps 1-4 to activate up to fifteen more stations.

 *As stations are activated, the master valve (MV) and/or pump (P) associated with that station will be highlighted, indicating they will activate along with that station. It is possible to manually enable and disable the master valve/s and pump/s, although Toro does NOT recommend that.*

To Deactivate Simultaneous Station Operation:







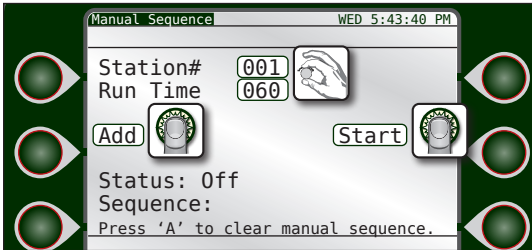



- 1)  to **Deactivate** field.
- 2)  to deactivate.

Sequence

Sequence allows stations to be activated in a non-linear sequence.



To Activate a Sequence Operation:

- 1)  to enter **Station#** field.
- 2)  to select desired station.  Set it.
- 3)  to **Run Time** field.
- 4)  to set a run time.  Set it.
- 5)  to **Add** field.  to add station to the sequence.
- 6) Repeat steps 1 - 5 to add as many stations as desired to the sequence.
- 4) To begin the manual program,  to **Start** field.  to start. Irrigation will begin immediately.

To Cancel a Manual Sequence Operation:

Once a Sequence operation has started, the **Start** field will read **Stop**.

- 1)  to the **Stop** field and .
- or -



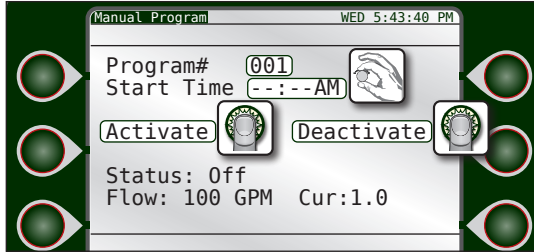

- 1) Hit the **All Stop** button  (which stops all irrigation, not just the Sequence).

Program



Manually executing a program will run the program at the specified start time.



To Activate a Manual Program Operation:

- 1)  to enter **Program#** field.
- 2)  to select desired program.  Set it.
- 3) Use the Control Dial to enter, adjust, and set the remaining fields.
- 4)  to begin the manual program.
Irrigation will occur at the specified start time.

To Deactivate a Manual Program Operation:

- 1)  to **Deactivate** field.
- 2)  to deactivate.

Chapter 11: Review

Overview

The review screen allows the user to review all facets of the controller setup and programming, including System Review, Program Review, About, Station Review, Flow Review, and Weather Review.

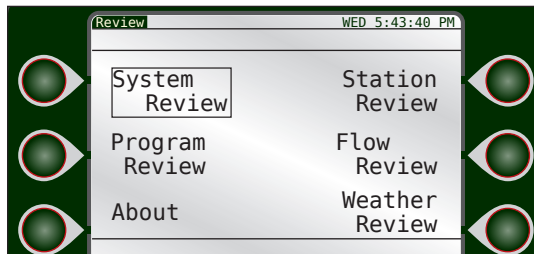

System Review

The System Review section allows a user to review all valid programs, including establishment programs, standard programs, and ISC programs.

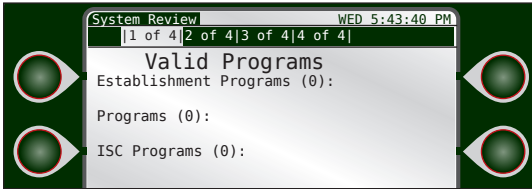

The second of 4 screens displays the satellite type and firmware revision.

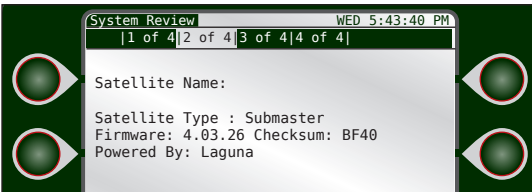

The remaining pages display the omit days for the controller.

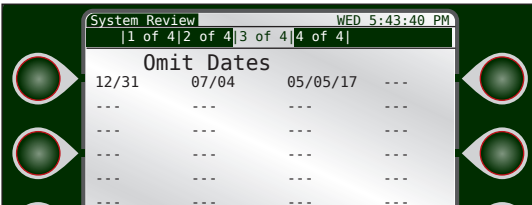

Program Review

Program Review displays five screens of information related to the selected irrigation program.

1/5:

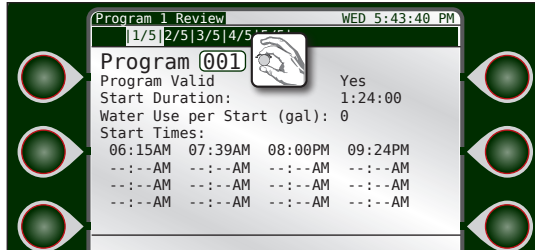

- **Program Valid:** Yes or No. For a program to be valid, it must have four settings: a Start Time, a Run Time, water days, and assigned stations.
- **Start Duration:** Displays how long the entire irrigation program will run in hours and minutes.
- **Water Use per Start (gal):** Displays the number of gallons the irrigation program uses. Water usage is calculated based off the nominal station flow value. See **Chapter 7, Stations** for entering nominal flow values or performing a Learn Flow
- **Start Times:** Shows the start and end times for each program start.



When toggling between program numbers, it is common for the controller to have a 1-2 second delay before populating the data.

2/5:

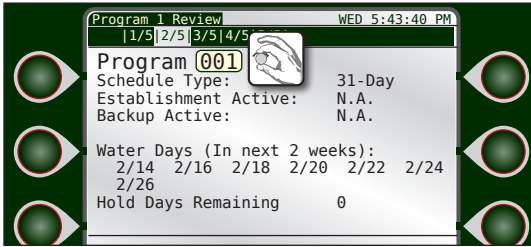

- **Schedule Type:** Displays what type of schedule is set for this program, either 31-Day, 14-Day, or Interval.
- **Establishment Active:** Pertains to programs 15E & 16E, which utilize an establishment or grow in period for new seed. See chapter 6, Program Entry for details on establishment programs 15E and 16E
- **Water Days (in next two weeks):** Displays the dates of the irrigation days over the next two weeks.
- **Backup Active:** Pertains to programs 10 and 11, which are utilized as a backup irrigation programs when using Laguna central software Advanced Irrigation Management (AIM) or Advanced ET generated Independent Station Control (ISC) algorithms. If an ISC fails to download from central to the controller for more than 24 hours, the backup program will run its irrigation program.
- **Hold Days Remaining:** Pertains to how many local program level Rain Hold days remain for that program. Global Rain Hold events are not relevant here.

3/5:

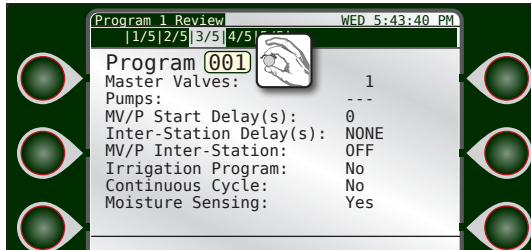

This screen displays the OPT IN's set for the specified program.

- **Master Valves:** All master valves associated with that program.
- **Pumps:** All pumps associated with that program.
- **MV/P Start Delay(s):** The number in seconds of the MV/P Start Delay.
- **Inter-Station Delay(s):** Whether or not there is an inter-station delay.
- **MV/P Inter-Station:** If a MV/Pump is activated in-between station activations.
- **Irrigation Program:** Displays whether the program is an irrigation program or a non-irrigation program.
- **Continuous Cycle:** Displays whether the program will continuously cycle.
- **Moisture Sensing:** Displays whether the program uses moisture sensing from an attached soil sensor or not.

4/5:

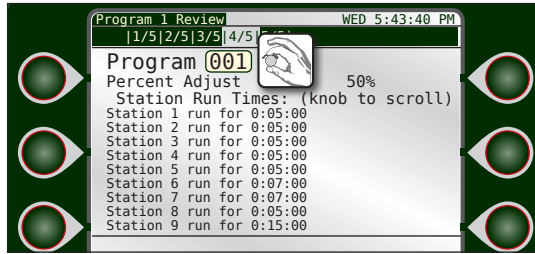

- **Percent Adjust:** Displays the Percent Adjust set in *Chapter 5: Program Entry*.
- **Station Run Times:** Displays how long each station will run, taking into account the Percent Adjust setting.
- Turn the Control Dial to see more station run times.

5/5:

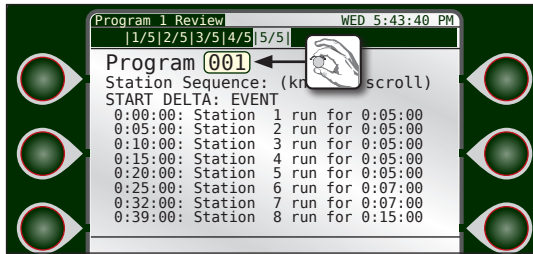

- This screen displays the exact timing for each station from the start. Cycle and Soak behavior is taken into account.

Station Review

Station Review shows irrigation information for each station attached to the controller.

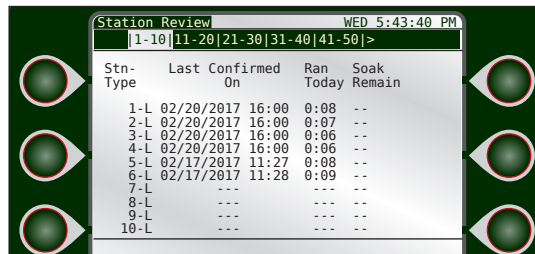

- **Station Type:** "L" - local conventional station
 "D" - 2-wire decoder station
- **Last Confirmed On:** The last date and time that station was active.
- **Ran Today:** The number of minutes the station was active.
- **Soak Remain:** Displays the Soak time left (if any) from the Cycle and Soak setting.

Flow Review

Flow Review displays information about the various flow meters (if any) that are added to the system, as well as the system Flow Limits.

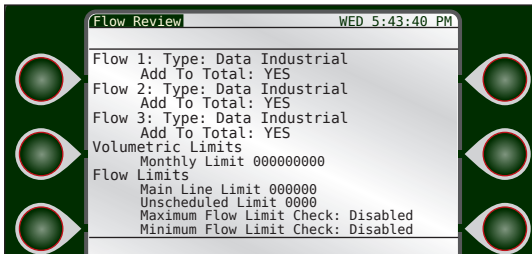

All of this information is set under **Setup** --> **Flow**.

About

Version

Displays the controller name, version, checksum, build, bootloader type/version, the controller serial number (set at factory), and Cloud ID (set at factory).

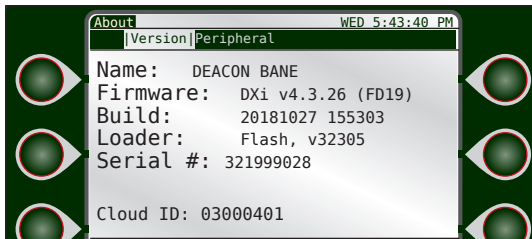

Peripheral

Displays any attached peripheral ID and firmware version.

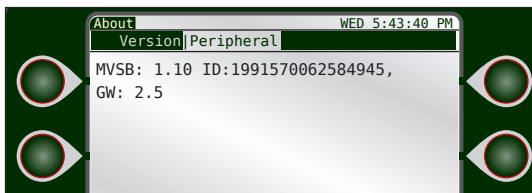

Weather Review

Review

This screen shows recent weather information for the previous week such as rainfall in inches, ET in inches, and current wind speed. Appropriate sensors and/or data sources must be attached to generate this data.

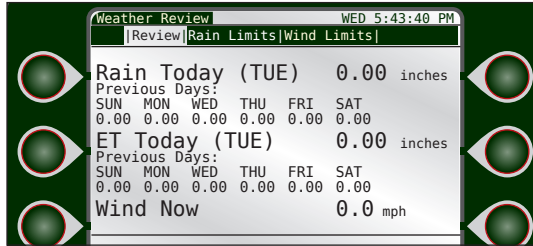

Rain Limits

Rain Limits screen displays both the hourly and daily threshold limits and totals. If rain limits are met or exceeded, the controller will issue an alert which the user can respond to from the Laguna central computer.

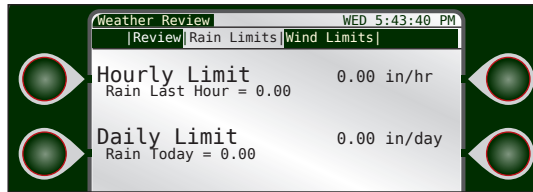

 Thresholds can only be set via Laguna central software.

Wind Limits

Wind Limits screen displays the wind shutdown and resume settings. If wind is measured at or above the Wind Shutdown speed for the Duration Required, the controller will issue an alert which the use can respond to from the Laguna central computer.

 Thresholds can only be set via Laguna central software.

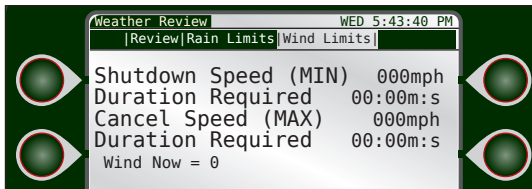

Shutdown speed: The minimum wind speed (for the duration specified) to trigger an irrigation shutdown.

Cancel speed: The maximum wind speed that cannot be exceeded for the duration specified that cancels, automatically, a wind speed shutdown.

Duration Required: Time interval required for a shutdown or resume limit to be valid.

Chapter 12: Troubleshooting

This chapter describes the resources available to troubleshoot field wiring problems, broken heads, pipes and mainlines, AC power problems, monitoring of water usage, and more.

In order to take full advantage of all the capabilities of the DXi controller as a maintenance tool, refer to the following manual sections for operational information and proper setup:

- **Flow Monitoring:** See **Appendix B: Flow Meters**
- **Broken field wiring, short circuits, and faulty valve solenoids:**
See **Appendix C: Current Monitor**

Communications Wiring Issues (Satellite to Satellite)

All alerts are systematically retrieved and recorded by the Central Control Computer. Central software has reporting tools to comprehensively sort, organizer and filter alerts by various parameters.

DXi satellite groups use a daisy chain configuration, that will result in failed communication to all downstream devices at the point of failure. Here is an example:

A FLOWMAX group is hardwired together consisting of four satellites

Submaster_001-00 <-> Satellite_001-01 <-> Satellite_001-02 <-> Satellite_001-03

If the communication line is severed between satellite 001-01 and 001-02, all satellites downstream of 001-01 lose communication with the submaster. In this case, that would be Satellite_001-02 and Satellite_001-03. This would result in alerts at the submaster for loss of communication with the given satellites and an alert at satellites 001-02 and 001-03 for loss of communication with the submaster.

Submaster

If the submaster loses communications with one of its hardwired satellites, a hardware (HW) communications failure is detected (below). An entry is made in the submaster's alert list.

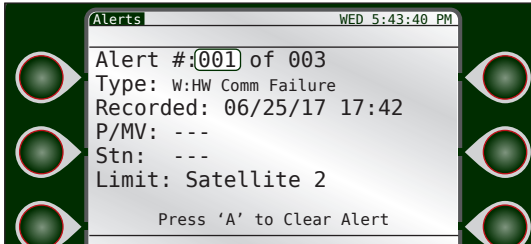

Satellite

When a satellite loses hardware communication, it is "off-line". When communication is re-established, it is "on-line" (see Alert below). When a satellite becomes off-line or on-line, an entry is logged in the satellite's alert list.

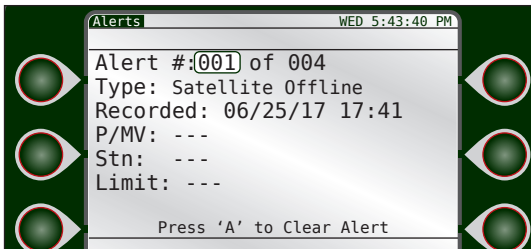

Communication Wiring Issues (Satellite to Station):

For both conventional and 2-wire decoder stations, if a satellite cannot communicate with a given station, a specific alert will be generated.

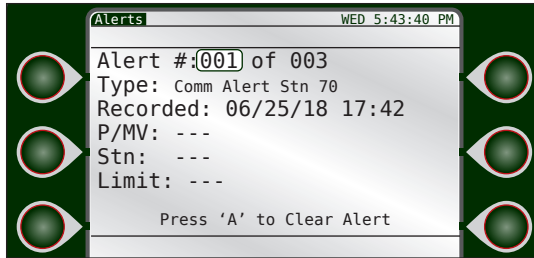

For conventional stations, verify the cable connection to the output board responsible for that station. Verify the output board has the proper power and status LEDs illuminated. Under the "Review -> About" menu, verify the Opt. FW for the given output board is displayed. If the cable connection is good but the power/status LEDs are not illuminated correctly, or the Opt. FW cannot be read, contact a Toro service representative.

For 2-wire decoder stations, verify the cable connection to the 2-wire output board. Verify the 2-wire output board has the proper power and status LEDs illuminated. Verify the field wiring connection to the 2-wire output board. In the field, check the field wiring and connections to the given station.

Diagnostics

The DXi controller utilizes several advanced tools for communication troubleshooting. These tools are used by RMIS service personnel to diagnose and correct field communication problems. These tools are detailed in **Chapter 7: Reports and Diagnostics**.

Directory of Flow Chart Diagnostic Problems

Problem / Symptom	Page
Multiple Stations Do Not Water (Many station lights on)	85
Short Circuit Shutdown	86
Automatic Program Does Not Start	87
Flow Sensor Reading Always Zero	89
A Station/Valve Does Not Water	92
Display is Blank	95
Program Starts-But Does Not Water	96
Program Starts-But Stations Shut Off Immediately	97
Monthly Flow Violation Occurred But Program Still Operates	98

Multiple Stations Do Not Water (Many station lights on)

Station LED for the suspect zone turns on, and other station LEDs turn on.

If a zone does not water but that station's red LED light turns on as well as other various LEDs for other stations, the field "common" wire for those stations is not connected (floating) to the controller. Check the field wiring common connection at the controller and at the field junction where they may be tied together. Check for continuity of the common line from the controller to the field valve.

The following schematic diagram illustrates a sample wiring configuration of four solenoids connected to station outputs:

Controller Station Output Board

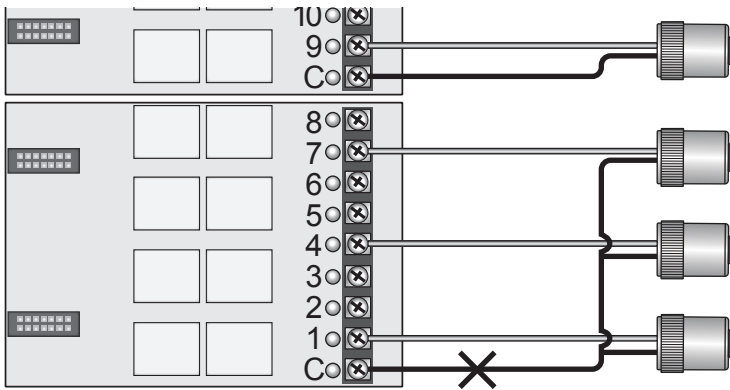

The solenoids connected to station outputs 1, 4, and 7 share one common line return to the station output board. Station #9 is shown as a normal operating station, which is connected independently from the other stations (not sharing the common connection).

If the common line is broken or open (as shown by the cross marks), current does not flow and the solenoid is not energized. This condition is possible whenever groups of field valve wiring configurations are tied together to one common return line.

In the example above, if station 1, 4 or 7 are activated, the station LEDs for 1,4 and 7 will all illuminate but the solenoids will not energize.

Note: Station 9 LED will not be illuminated and solenoid will not be energized because station 9 does not share a common with station 1, 4 or 7.

Short Circuit Shutdown

A short circuit shutdown event is generated when the total cumulative current draw of all conventional outputs (stations, MV's and Pumps) measured by the MV/Sensor board exceeds 2.75Amps. An alarm will be generated and the MV/Sensor board will sever the common connection to all conventional outputs, preventing them from energizing. The severed common connection can be quickly diagnosed by the illumination of the shutdown LED (reads 'OFF' on main board cover).

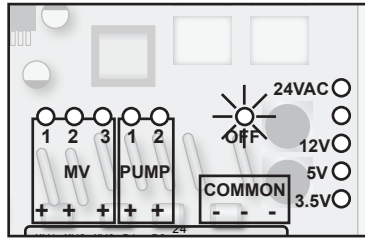

Once the alarm is cleared, the MV/Sensor board will reset the common connection.

Note: In the event of a short circuit shutdown, no station LEDs will illuminate if activated. If a MV or Pump is activated, all MV and Pump LEDs will illuminate in the same manner as station outputs sharing a common connection will, as described in the previous section.

Automatic Program Does Not Start

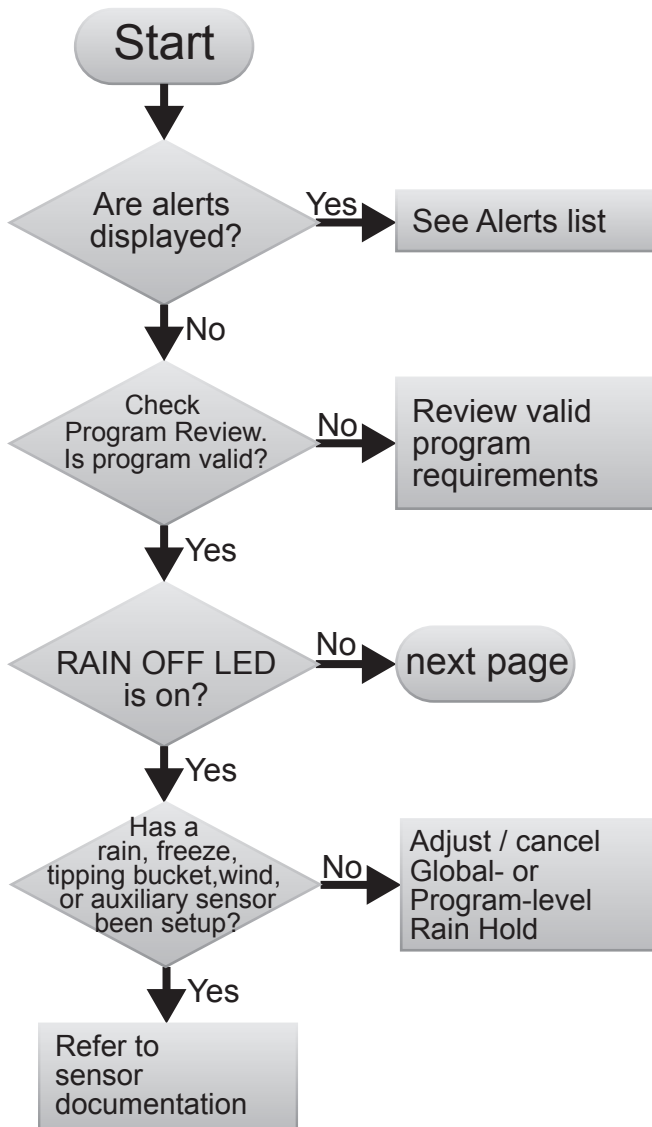

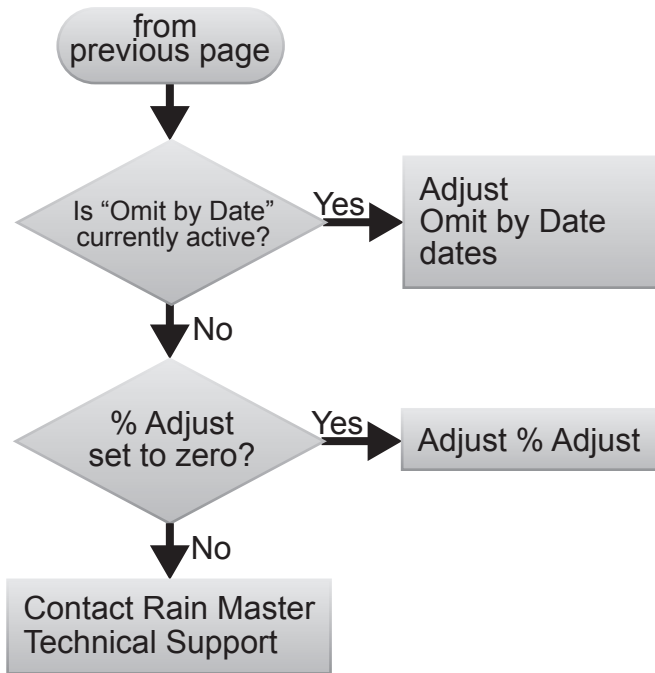
Automatic Program Does Not Start (continued)

Flow Sensor Reading Always Zero

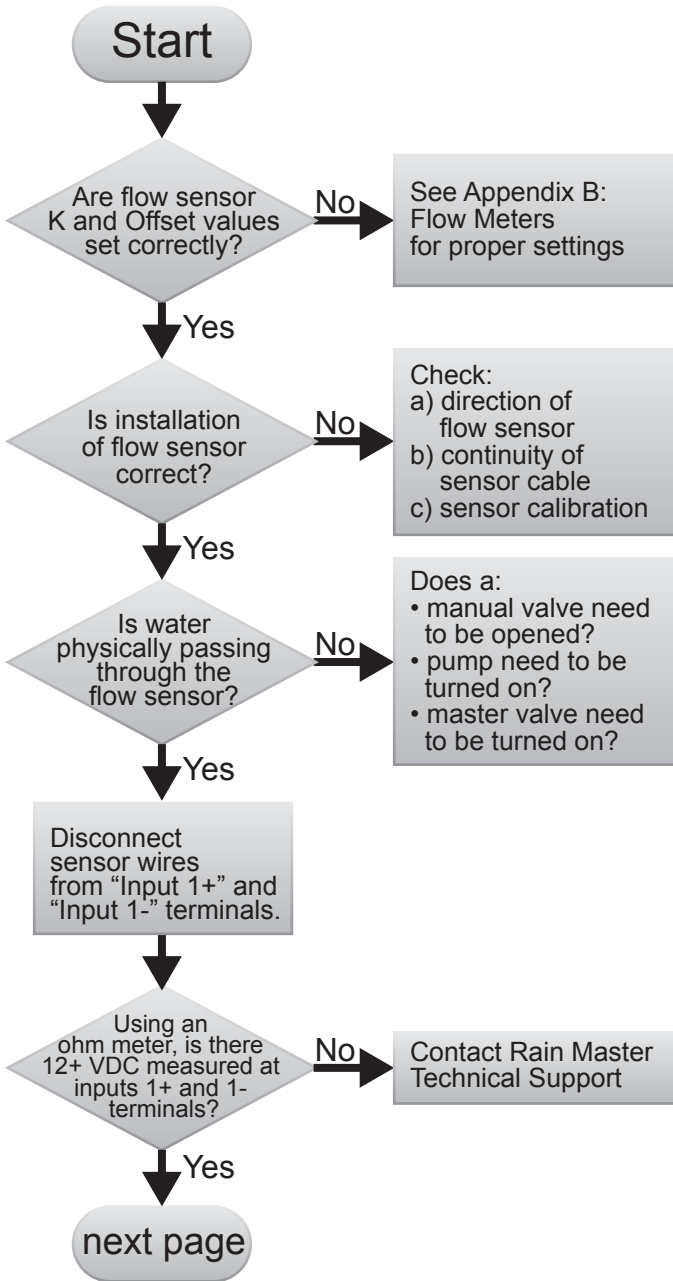

Flow Sensor Reading Always Zero (continued)

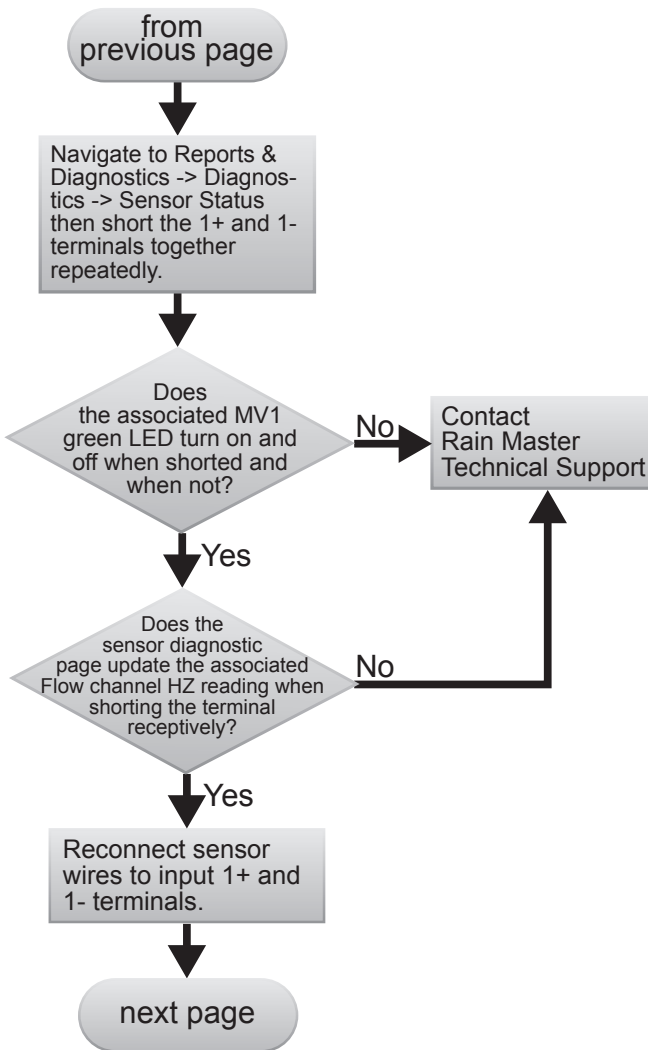

Flow Sensor Reading Always Zero (continued)

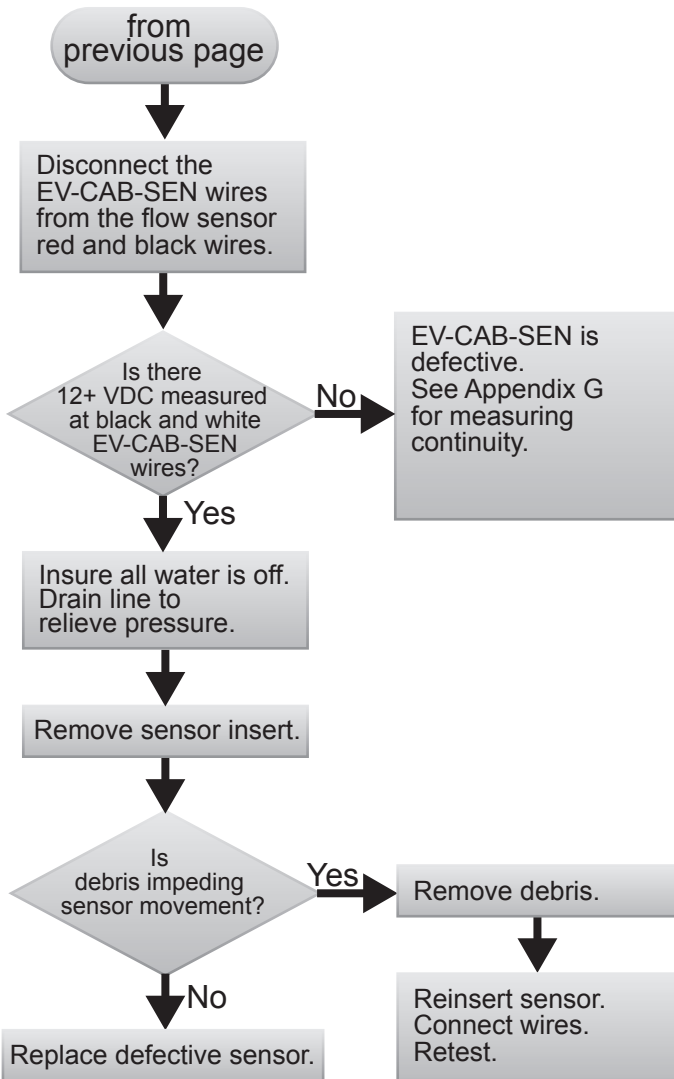

Station / Valve Does Not Water

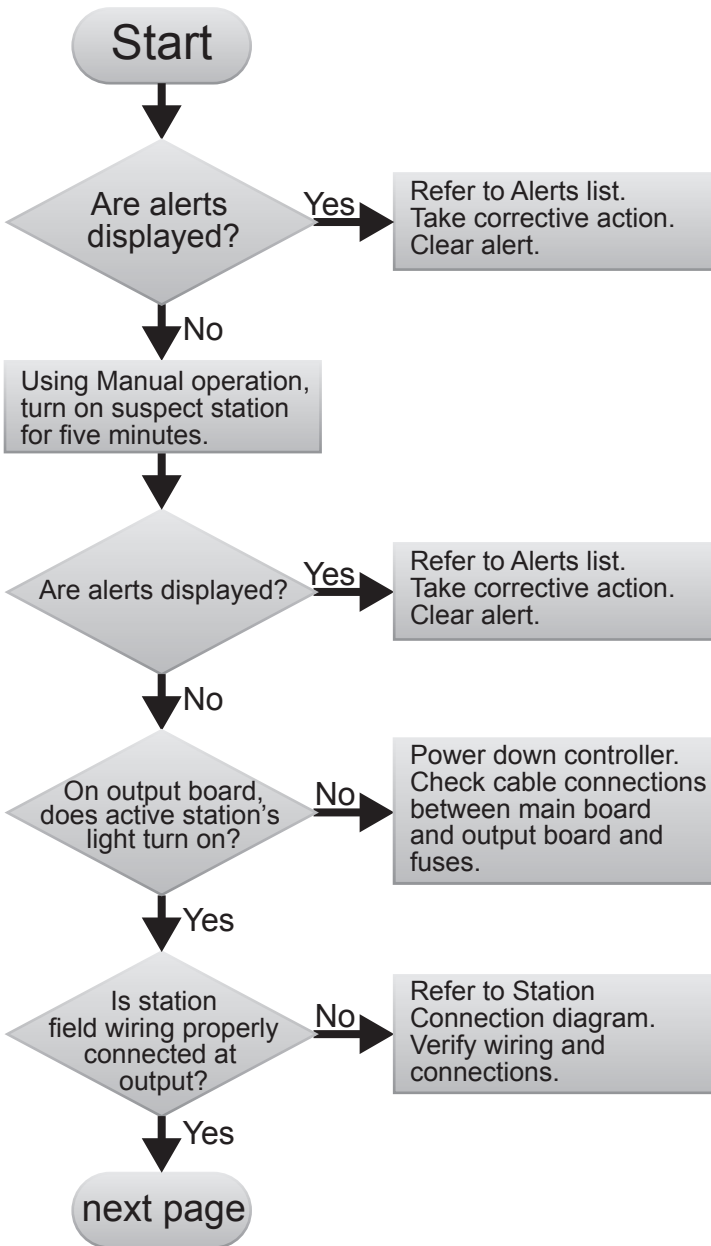

Station / Valve Does Not Water (continued)

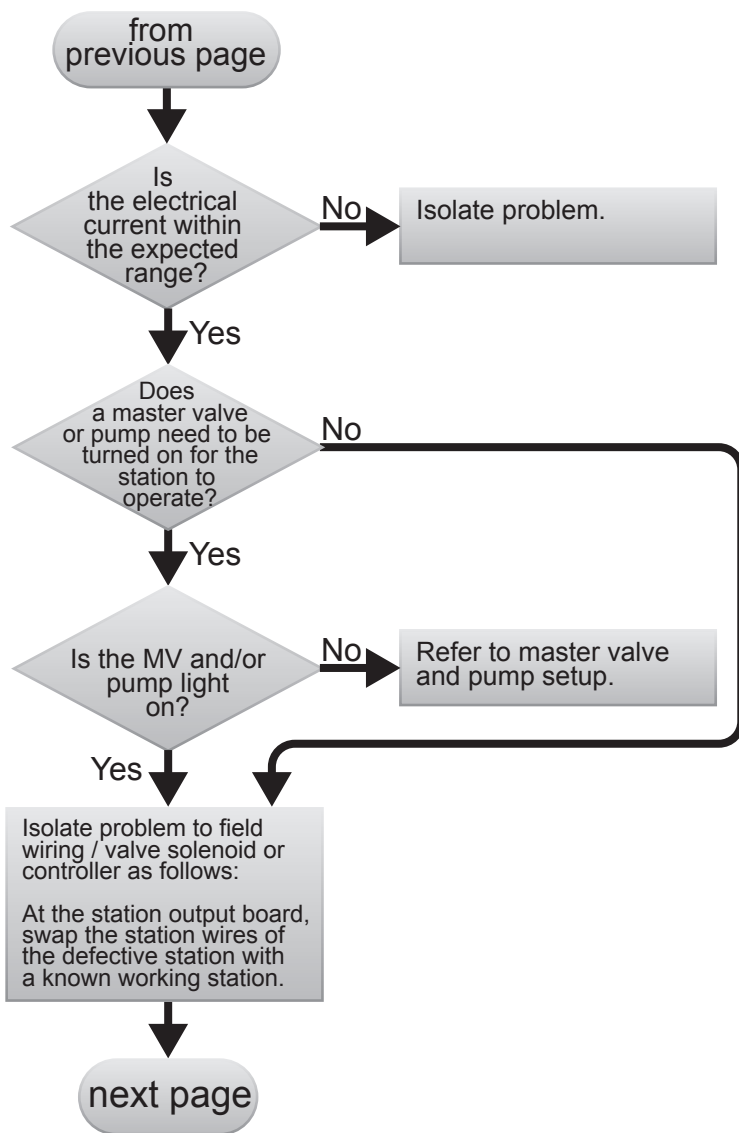

Station / Valve Does Not Water (continued)

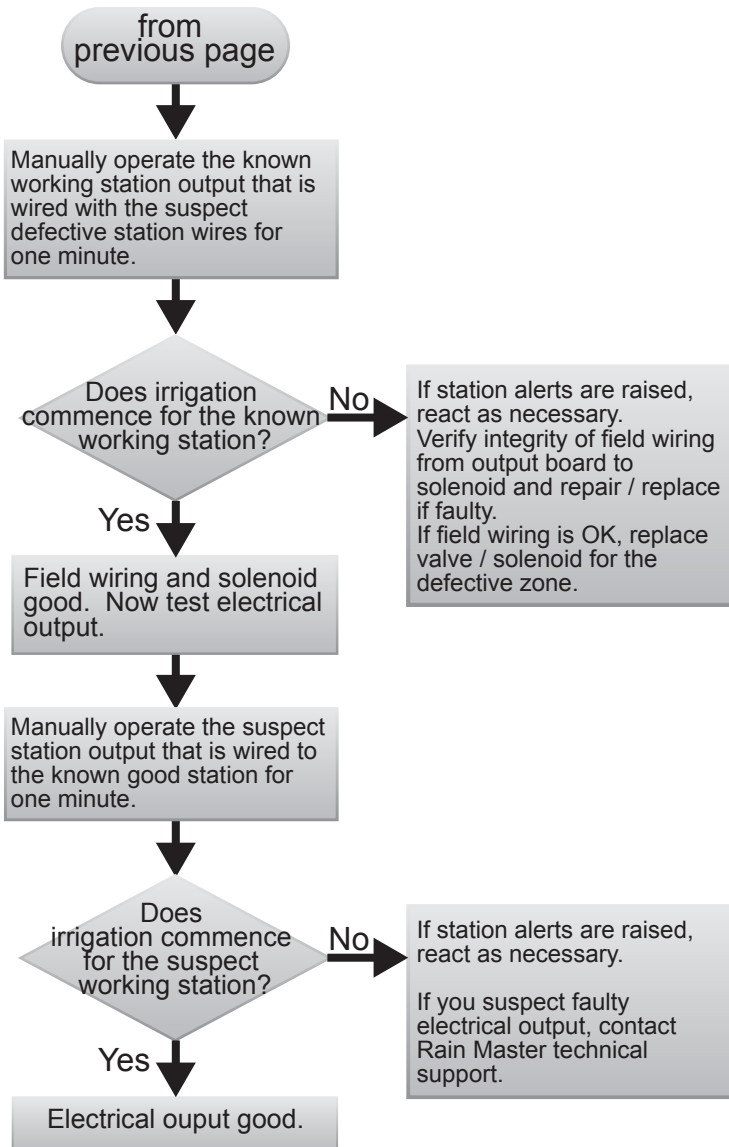

Display is blank

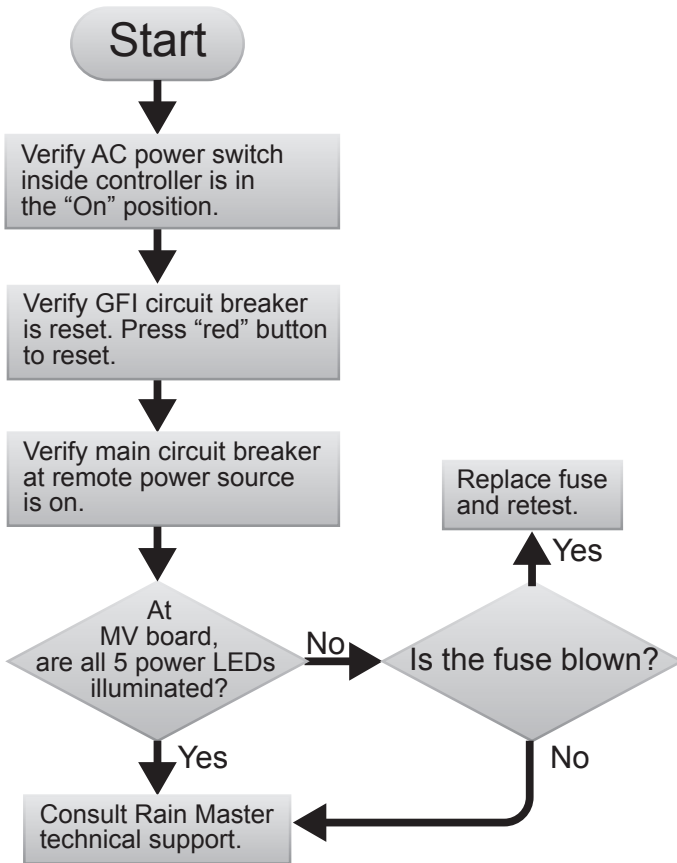

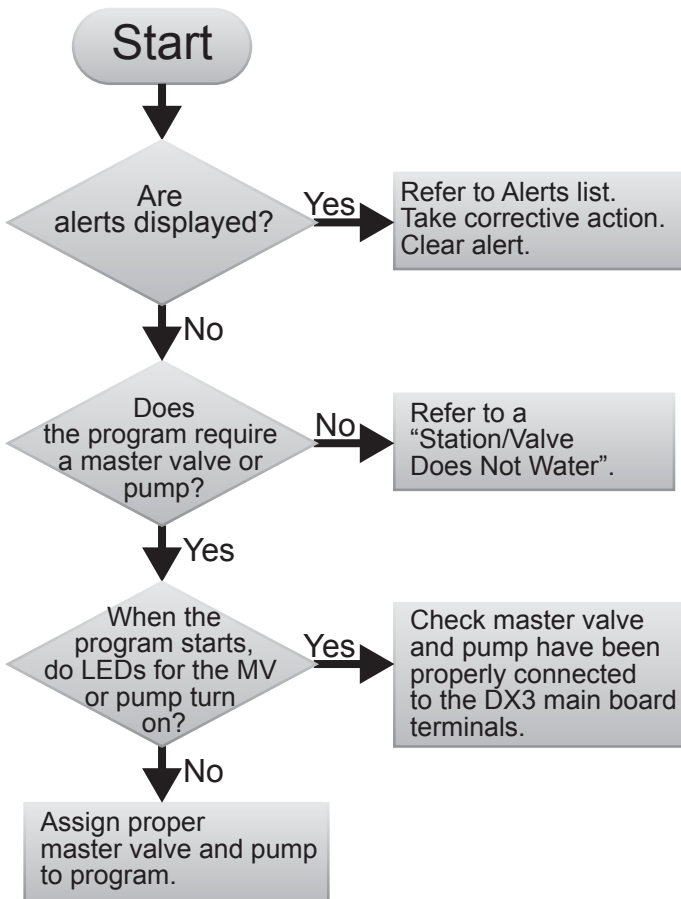
Program Starts But Does Not Water

Program Starts But Stations Shut Off Immediately

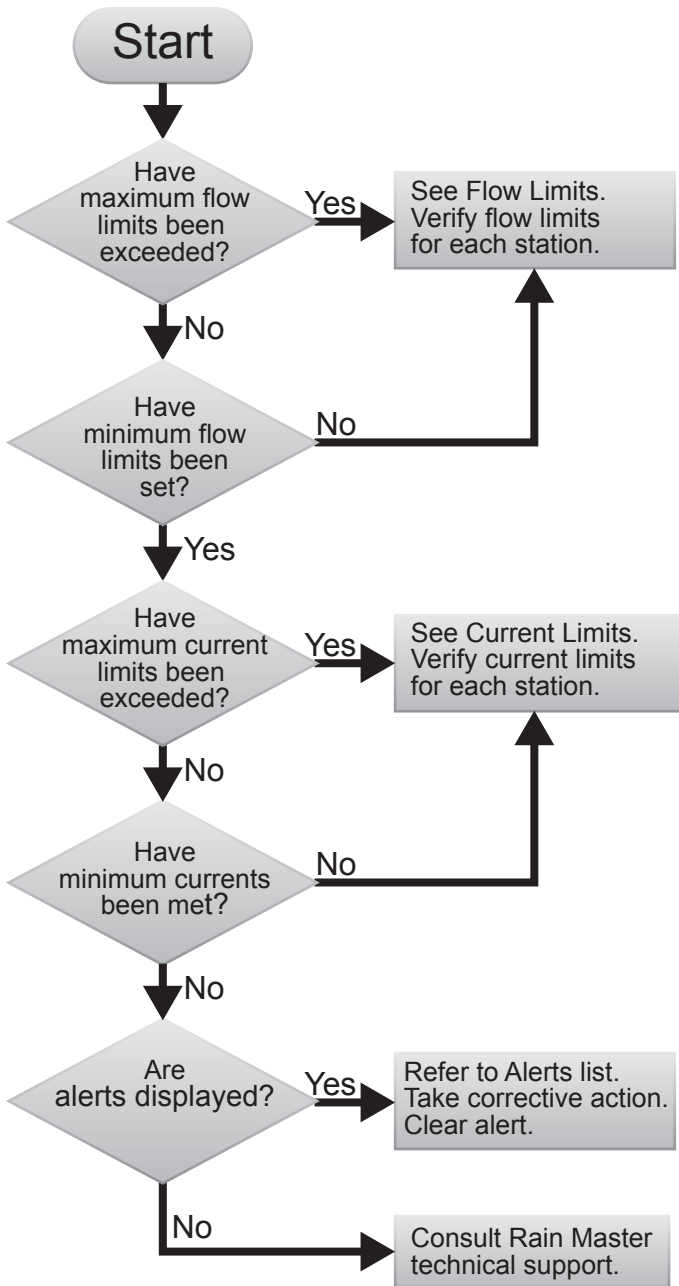

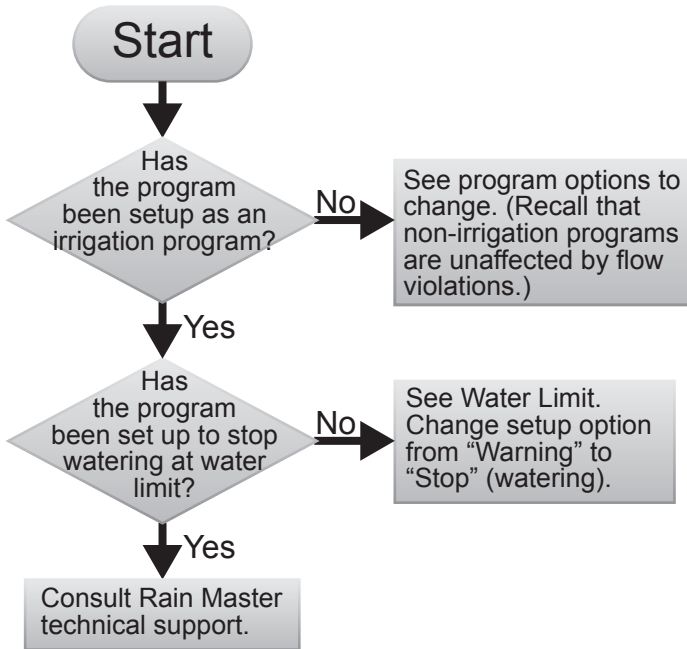
Monthly Flow Violation Occurred But Program Still Operates

Control Devices (Rain Sensors, Freeze sensors, Etc.)

Many commercial sensor devices available in today's market take advantage of the common ground configuration to control watering operations. Devices such as rain sensors, freeze sensors, moisture sensors, etc. employ a control system which interrupts the common ground line of watering stations to control the shutdown of stations.

These devices have inherent limitations:

1. They exhibit "contact bounce" or jitter when the on/off threshold is reached. This may have adverse affects on pump systems.
2. Since they interrupt common lines, non-irrigation programs such as lighting programs are also affected.
3. It may be difficult to identify/interrupt the "common" wire if multiple commons come in from the field.

The DXi avoids these limitations with two dedicated contact closure inputs available at the MV/Sensor board, Alarm Inputs 1 and 2. Rain or freeze sensors can be connected that will accomplish the controller shutdowns without breaking the common ground line.

Appendix A: Specifications

Cabinet Dimensions:

- Wall Mount: 11" W x 16" H x 5.625" D (27,9cm W x 40,6cm H x 14,29cm D)
- Pedestal Mount:

PSB: 16.5" W x 38" H x 17.25" D (41,9cm W x 96,5cm H x 43,8cm D)

SPED: 16" W x 34" H x 16" D (40,6cm W x 86,4cm H x 40,6cm D)

Temperature Range:

- Operating: +14°F to +140°F (-10°C to +60°C)
- Storage: -22°F to +149°F (-30°C to +65°C).

Power Specifications:

- Internal Transformer, Class 2, UL Listed, CSA Certified (or equivalent)

Input: 120 VAC, 60 Hz, 1A

Output: 24 VAC, 50/60 Hz, 100 VA max

- Junction Box Power Outlet: 120 VAC, 5 AMP max
- Maximum Load Per Station: 2.5A @ 24 VAC @ 77° (25°C)
- Maximum Load Per Master Valve: 2.5A @ 24 VAC @ 77°F (25°C)
- Maximum Load Per Pump Output: 2.5A @ 24 VAC @ 77°F (25°C)
- Total cumulative output load (station, MV, and pump): 2.75A
- Total Maximum Load: 4A @ 24 VAC.

Output Surge Protection (excluding 2-wire decoder models):

20KV common, 18KV normal.

Controller Memory:

The DXi utilizes Non-volatile Random Access Memory technology to protect all user-defined program and setup data from loss in the event of a power failure. Time and date settings will be maintained without power for approximately 1 day.

Appendix B: Flow Sensors

The DXi controller provides a variety of user-configurable, flow-related features for up to three flow sensors, referred to as Flow #1, Flow #2, and Flow #3. Flow sensors may be of both conventional and/or decoder type.

DXi flow features/capabilities include:

- Display of instantaneous flow rate in gallons per minute (GPM) for all three meters as well as total (Flow #1 + Flow #2 + Flow #3). Flow rates are updated every ten seconds.
- Display of monthly flow accumulations in gallons for all three flow meters as well as total (Flow #1 + Flow #2 + Flow #3). Flow accumulation in gallons is updated every minute.
- Automatic termination of watering based upon flow limit violations:
 - Main line flow rate for controller (GPM)
 - Maximum flow rate per station (GPM)
 - Minimum flow rate per station (GPM)
 - Maximum flow accumulation per month (gallons)
 - Unscheduled flow rate for controller (GPM)
- Automatic condemnation and reporting of stations violating flow limits. Alert information is provided in **Chapter 8: Alerts**.
- Automatic establishment of station upper and lower flow limits (Learn mode).

Flow Sensor Installation Instructions

The plastic cover of the DXi main board shows all inputs and terminal polarity. To install a Irritrol or Toro flow meter:

1. Power down the DXi controller.
2. Connect the white and black wires as shown.

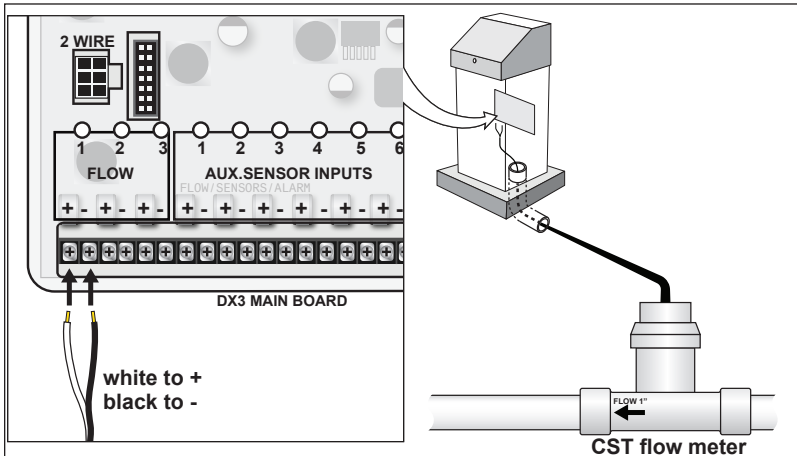

3. Return power to the controller.
4. To configure the flow sensor, go to **Setup-->Flow-->Flow Sensors**. See **Chapter 4: Setup** on how to navigate the Flow Sensors screen. Use the "Flow Meter Offset and K Values" tables (next page) to properly calibrate the flow sensor.

For complete installation and setup instructions of a Flow decoder, refer to Toro document 373-1022, TW-DAC-FLOW Decoder Installation Guide.

Flow Sensor Overview

To establish flow limit checking either on a controller or individual station basis, verify the following:

- Flow meter is installed properly.
- Correct Offset and K values are entered.
- Station Upper Limits have been established. See "Max Flow Limit".
- Station Lower Limits have been established. See "Min Flow Limit".
- Main line flow limits have been established. See "Main Flow".
- Total Monthly Flow has been set. See "Flow Options".
- Unscheduled Flow Limit has been defined. See "Unscheduled Flow Limit".
- Upper and lower limit checking is enabled. See "Enable/Disable Limit Checking".
- The appropriate flow limit check delay has been established. See "Delay Limit".
- Selection of at least one of the three flow meters.

See "Setup -> FLOWMAX, devices connected to this clock."

If all above steps are completed, typical accuracy values of flow sensor readings are approximately within 1%.

Flow Sensor Offset and K Values

Each flow meter installation must include entry of the "offset" value and "K" values for proper calibration of the meter. The DXi controller supports the complete line of Toro and Irritrol-branded flow sensor (DI & CST). Flow Sensors may be either conventional and/or decoder type. The controller can only have 3 in total.

Data Industrial® Flow Sensors

PVC Sensor Body Material

Sensor Model #	FS-150	FS-200	FS-300	FS-400
Pipe Size	1.5"	2"	3"	4"
Operating Range (GPM)	5-100	5-100	5-100	5-100
Max. Water Pressure	100 psi	100 psi	100 psi	100 psi
K-Value	457	776	2268	3752
Offset Value	0	104	483	834
Connection Type	Slip	Slip	Slip	Slip

Bronze Sensor Body Material

Sensor Model #	FS-B100	FS-B125	FS-B150	FS-B200	FS-B250
Pipe Size	1"	1.25"	1.5"	2"	2.5"
Operating Range (GPM)	2-40	3-60	4-80	10-100	16-160
Max. Water Pressure	400 psi	400 psi	400 psi	200 psi	200 psi
K-Value	109	209	291	750	1021
Offset Value	27	32	24	0	370
Connection Type	NPT Female	NPT Female	NPT Female	NPT Female*	NPT Female

* Includes copper male adapter.



In addition to the standard models listed above, an impeller-type flow sensor adapter, Model #FS-INSERT-B, is available to accommodate pipe sizes from 3" to 40" (7.6 to 102 cm). Requires pipe saddle with 2" female NPT inlet.

CST Flow Sensors

Sensor Model #	FS-10	FS-B15	FS-15	FS-20	FS-30	FS-40	FS-60
Pipe Size	1"	1.5"	1.5"	2"	3"	4"	6"
Operating Range (GPM)	.86-52	3-90	1.8-108	2.8-170	6-288	10-480	45-1080
Max. Water Pressure (psi)	240	250	240	240	150	150	150
K-Value	87	208	177	325	751	1237	2839
Offset Value	6	34	205	256	431	303	903
Connection Type	Socket	FIPT	Socket	Socket	Saddle	Saddle	Saddle

Flow Limit Checking

To perform limit checking, the controller computes a Gallon-Per-Minute (GPM) flow rate based upon the total gallons used in the previous 60 seconds.

Limit checks are performed on the following:

- Station upper limit
- Station lower limit
- Main flow limit
- Total monthly flow limit
- Unscheduled flow limit

Station limits can be automatically established by the controller or manually entered.

Station Limit

It is possible to enter a station flow limit by manually entering the station limit, as described in Chapter 7 or 11, or have the controller automatically set the limit during a "learn" process as described in Chapter 5. Ensure the flow check delay is set to a high enough value to allow for adequate hydraulic settling time for the flow meter readings to stabilize before obtaining the nominal flow rate.

The controller compares the flowmeter reading to the station limit. If the meter value is larger than the station upper limit, a high flow alert is raised. If the meter value is smaller than the station lower limit, a low flow alert is raised.

The suggested upper limit flow rate should be set to the nominal flow rate for the station +20%. The suggested lower limit flow rate should be set to the nominal flow rate for the station -20%.



If water pressure varies greatly, upper station limits should be increased.

Main Flow Limits

Enter the Main Flow Limit, as described in the Main Flow procedure in Chapter 5. The controller compares the flow meter reading to controller/main line station limit. If the meter value is greater than the limit, an alert is generated.

The system default value for controller/main line limits is 500 GPM.

The Main Flow upper limit should be set higher than the total of all simultaneously "on" stations. However, this limit should be lower than the anticipated flow rate from a main line break.

In Flow Max systems, the total water consumption of all participating controllers is calculated into the Main Flow limit.

Total Monthly Flow Limit

Enter a maximum monthly flow limit, as described in Chapter 4. The controller compares the accumulated monthly flow to maximum monthly flow limit. If the accumulated flow is greater than the limit, an alert is generated.

The system default value for maximum monthly total is 9,999,999.

If the monthly limit is exceeded, there are two options available, **STOP** and **WARNING**. See **Chapter 5: Program Entry** for details on selecting each option.

If the **STOP** option is selected, the problem is reported in the alert list and watering stops.

Watering is restarted when:

- the limit is changed to a larger value
- the program option is changed to Warning
- a new month begins

If the **WARNING** option is selected, an alert is reported in the alert list and watering continues.

Unscheduled Flow Limit

Unscheduled Flow Limit is defined as any water flow that is not programmed or under the control of the controller. If a water flow is greater than the limit, the flow check delay has been met, and no stations are on, the controller will shut down the water supply until the condition is corrected.

Unscheduled Flow conditions may be due to broken water lines, defective valves, faulty solenoids, etc.

The Unscheduled Flow procedure is given in the Controller Setup section of Chapter 4. The default limit is 0 GPM.

Enabling and Disabling Flow Limit Checking

Once the station limits have been established, the flow limit checking (upper and lower limits) may be enabled or disabled. When upper limits have been enabled, all station upper limits will be enforced. When lower limits have been enabled, all station lower limits will be enforced. See Chapter 4 for the steps to enable or disable station flow limit checking.

When limits are disabled, no limit checking is performed. However, the GPM flow, total monthly flow readings, the Monthly Limit, Main Line Limit, and unscheduled limits are all unaffected.

Delaying Flow Rate Limit Checking (Flow Check Delay)

Due to drainage of water lines, the initial flow rate for a station may be much higher than the station steady state condition. To prevent erroneous station fault detections, the controller delays a period of time after a station is turned on before making flow rate limit checks. This delay may be set from 2 to 6 minutes.

The system default for delay of limit checking is two (2) minutes.

To establish the proper delay, monitor the GPM flow rate for each station in the irrigation program(s).

Observe which station takes the longest time for its GPM rate to "settle." Round this time period to the next minute and use this rounded value as the flow rate limit check delay.

Limit Checking with Two or More Flow Meters

When two flow meters are used, you may select which meter is used for limit checking. Alternately, you may check the total flow from both meters. Do this by:

1. Under Setup --> Flow --> Flow Sensors, the Include in Total Flow setting must be set to YES for both meters.

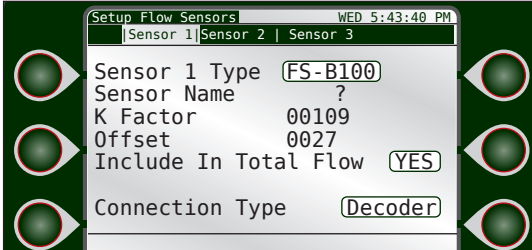

2. Under Setup --> FLOW MAX, the Sensors must be activated under "Devices Connected to this Clock".

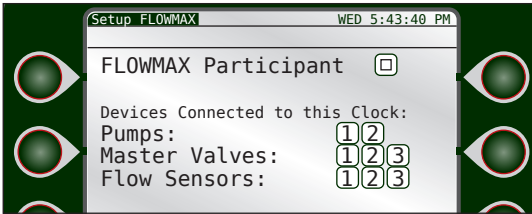

Flow Meter Reading

1. Go to REVIEW --> Flow Review.
2. The meter flow readings for Flow 1, Flow 2, and Flow 3 are shown in Gallons-Per-Minute. Readings are updated every 10 seconds.

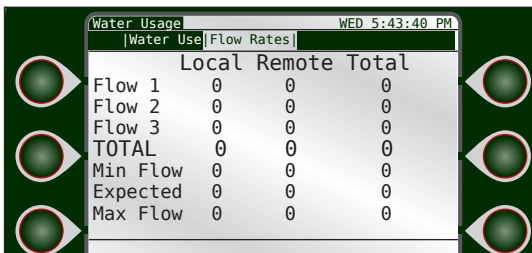

Reading Monthly Water Totals

1. Go to **Reports & Diagnostics-->Reports-->Water Usage**.
2. The monthly water totals indicate how much water has passed through a flow sensor in a given month.

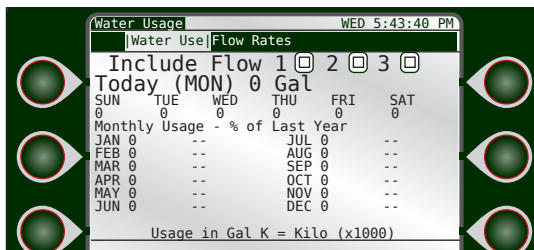

In order for flow values to be tracked, the "Devices Connected To this Clock" option must be selected under the Setup -> FLOWMAX.

Flow Limit Violations

When a Flow Limit Violation is Detected

Upon detection of a flow limit violation, DXi performs the following actions:

1. Terminate irrigation
 - For a faulty station, immediate termination of irrigation for that station. The program will automatically advance to the next station in the program.
 - If a main line fault is detected, immediate termination of all irrigation programs. The Normally Open (N.O.) Master Valve terminal is energized with 24 VAC. Any and all future automatic irrigation will not occur until this warning is cleared from the controller.
 - If the monthly watering allocation has been exceeded, immediate termination of all irrigation on a per program basis occurs.
 - If an unscheduled flow condition is detected, the Normally Open (N.O.) Master Valve terminal is energized with 24 VAC. Any and all future automatic irrigation will not occur until this warning is cleared from the controller.

2. Entry of the problem in the Warning/Report list.

3. All faulty stations are added to a "condemned" station list. No watering will occur until the problem is corrected.

To remove a station from the condemned list, delete the corresponding alert.

Examples

Overflow in Controller/Main Line Break

Assume the maximum controller flow rate is 500 GPM. A main line break occurs while attempting to water station 7. The break results in a flow of 510 GPM. The following alert is displayed, as well as the station number and GPM reading:

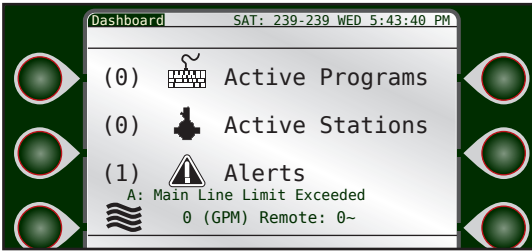

If we were then to drill down into the alert, we could see more information about this condition. All irrigation is suspended until the alert is cleared. In addition, Normally Open Master Valves are energized.

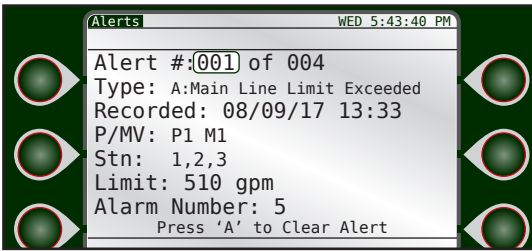

The 'Limit' number above is the actual flow value at the moment the alarm was triggered.

 *This situation may also be caused by a valve that fails to close.*

Station Overflow

Assume station 2 has an upper limit of 300 GPM. A broken line occurs, resulting in a 400 GPM flow. Resulting action in this example will be the generation of a High Flow alarm, station 2 will be condemned from any current or future irrigation, and the alarm is cleared.

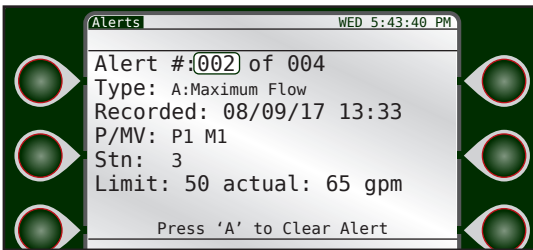

Station Under Flow

Assume station 2 has a lower limit of 100 GPM. The line to station 2 is clogged, resulting in a flow reading of 53 GPM. Resulting action in this example will be the generation of a Low Flow alarm and station 2 will be condemned from any current or future irrigation and the alarm is cleared.

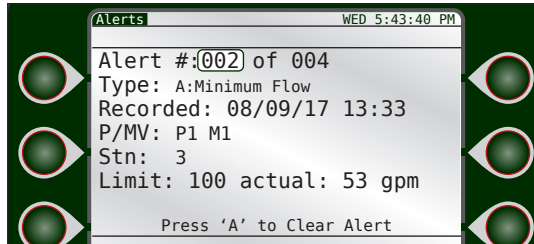

Monthly Water Limit Exceeded

The controller has exceeded its monthly watering allocation. This problem cannot be cleared from the report until the water limit is set to a higher value or until a new month begins. Irrigation will continue uninterrupted for non-irrigation programs or irrigation programs that have selected the "Warning" option for monthly limit (see Setup menu, chapter 5). Irrigation programs that have selected the "Stop" option, however, will be suspended until the alarm is cleared.

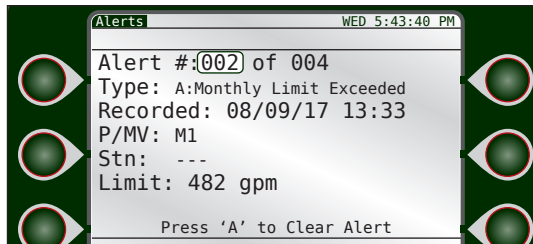

Multiple Stations with Non-Overlap Protection

The DXi controller allows the user the capability of turning "on" several stations simultaneously. When flow meters are used in this environment, the individual station limits are summed and compared to the total flow rate. Therefore, you must set up limits for each station to insure that flow limit checks are performed properly.

Example:

Assume the upper limit for station 1 is 80 GPM and the upper limit for station 2 is 50 GPM. If both stations are on, the controller adds these limits. A problem is reported if the flow exceeds the total of 130 GPM (80 GPM + 50 GPM).

Appendix C: Current Alarms Within a Conventionally Wired DXi System

Note: This document pertains to Toro DXi submasters, DXi FLOWMAX groups and mixed DXi and DX2 FLOWMAX groups activating conventional station types. This document presents scenarios on how a DXi system measures and responds to current related alarms. For details on how pure DX2 FLOWMAX groups measure and respond to current related alarms, please refer to the DX2 user manual.

Overview: A DXi controller has the capability to measure master valve (Mx), pump (Px) and station (Sx) current and compare against minimum and maximum limits. A user can globally enable/disable current limit checking for a controller via Laguna or the controller setup menu.

If current limit checking is enabled and the current measured for an output is below the minimum or above the maximum, an alarm is generated, and the output is condemned from future irrigation until the user clears the associated alarm. If multiple outputs are ON during the violation, irrigation is suspended (valves are deactivated, and program runtimes continue to decrement), a diagnostic process is started to determine the offending station(s) and alert(s) are generated for each output in violation, condemning them from future irrigation until the user clears the associated alarms. A diagnostic will only be ran once for a given group of stations and start time. After the diagnostic process has completed automatic irrigation operations are resumed, but manual operations are terminated.

Each over/under current alarm for a MV, Pump or station will contain the timestamp of the violation, the measured current and the limit value compared against.

A DXi will perform limit checking on Master Valves and pumps if current limit checking is enabled and condemn if necessary.

All station, Master Valve and Pump related over/under current condemnations (alerts) must be cleared for a given output, otherwise no activation will occur. A DXi controller will block a program from starting if it utilizes a condemned Master Valve or Pump. Manual operations will activate any output that is not condemned.

Current alarms are only generated at the satellite activating the output, all other FLOWMAX participants will be unaware of the alarm and will attempt to run their automatic programs.

All satellites will report measured current and compared limit for each under/over violation. Laguna will report the measured value, satellite compared limit and Laguna max, min and nominal limits for station violations, but only the measured value and satellite compared limit for MV's and Pumps.

Current Alarm Formats as Reported by Laguna:

1139 - Actual current is above maximum allowed current: MVx: actual current exceeded allowed current <sat measured, sat maximum>

1141 - Actual current is above maximum allowed current: Px: actual current exceeded allowed current <sat measured, sat maximum>

1120 - Actual current is above maximum allowed current: Sx: actual current exceeded allowed current <sat measured, sat maximum> , <Laguna Min, Laguna Max, Laguna Nom>

1005 (DX2) - Station Current too high: Sx: Station electrical current too high <StationX, Pump, MVx, sat measured>, <Laguna min, Laguna Max, Laguna Nom>

1004 (DX2) - Station Current too low: Sx: Station electrical current too low <StationX, Pump, MVx, sat measured>, <Laguna min, Laguna Max, Laguna Nom>

1140 - Actual current is below minimum allowed current: MVx: actual current below minimum allowed current <sat measured, sat maximum>

1142 - Actual current is below minimum allowed current: Px: actual current below minimum allowed current <sat measured, sat maximum>

1121 - Actual current is below minimum allowed current: Sx: actual current below minimum allowed current <sat measured, sat maximum> , <Laguna Min, Laguna Max, Laguna Nom>

Example Scenarios:

Scenario 1 - DXi submaster 001-00 begins automatic irrigation operation of program 1, by activating MV1, Pump1 then station 1. After station 1 is activated the measured current exceeds the maximum allowed current.

FLOW MAX Group	Satellite Type	Master Valves "ON"	Pumps "ON"	Station "ON"	Min Current	Nominal Current	Max Current	Total Min. Current	Total Measured Current	Total Max. Current
Sub 001-00	DXi	M1	P1	1	M1 = 0.20 P1 = 0.25 S1 = 0.15	M1 = 0.25 P1 = 0.30 S1 = 0.20	M1 = 0.29 P1 = 0.34 S1 = 0.24	0.60	0.90	0.87
Sat 001-01	DXi									
Sat 001-02	DX2									
Sat 001-03	DX2									

Result 1 - DXi submaster 001-00 suspends irrigation (valves are deactivated, and program runtimes continue to decrement) and starts diagnostic process.

DXi submaster 001-00 activates M1, verifies current is in range, and deactivates M1.

DXi submaster 001-00 activates P1, verifies current is in range, and deactivates P1.

DXi submaster 001-00 activates S1, verifies current is above maximum allowed, and deactivates S1. DXi submaster 001-00 raises alarm 1120 "Station Maximum Current" and condemns S1.

DXi submaster 001-00 resumes automatic irrigation operation of program 1, for none condemned stations. Manual or automatic operations will not activate S1 until alarm is cleared.

Scenario 2 - DXi submaster 001-00 begins automatic irrigation operation of program 1, by activating MV1, Pump1 then station 1. After station 1 is activated the measured current exceeds the maximum allowed current.

FLOW MAX Group	Satellite Type	Master Valves "ON"	Pumps "ON"	Station "ON"	Min Current	Nominal Current	Max Current	Total Min. Current	Total Measured Current	Total Max. Current
Sub 001-00	DXi	M1	P1	1	M1 = 0.20 P1 = 0.25 S1 = 0.15	M1 = 0.25 P1 = 0.30 S1 = 0.20	M1 = 0.29 P1 = 0.34 S1 = 0.24	0.60	0.90	0.87
Sat 001-01	DXi									
Sat 001-02	DX2									
Sat 001-03	DX2									

Result 2 - DXi submaster 001-00 suspends irrigation (valves are deactivated, and program runtimes continue to decrement) and starts diagnostic process.

DXi submaster 001-00 activates M1, verifies current is in range, and deactivates M1.

DXi submaster 001-00 activates P1, verifies current is in range, and deactivates P1.

DXi submaster 001-00 activates S1, verifies current is in range, and deactivates S1.

DXi submaster 001-00 resumes automatic irrigation operation of program 1. Since no violation could be confirmed, no alerts are raised and no stations are condemned.

Scenario 3 - DXi submaster 001-00 begins automatic irrigation operation of program 1, by activating MV1, Pump1 then station 1. After station 1 is activated the measured current exceeds the maximum allowed current.

FLOW MAX Group	Satellite Type	Master Valves "ON"	Pumps "ON"	Station "ON"	Min Current	Nominal Current	Max Current	Total Min. Current	Total Measured Current	Total Max. Current
Sub 001-00	DXi	M1	P1	1	M1 = 0.20 P1 = 0.25 S1 = 0.15	M1 = 0.25 P1 = 0.30 S1 = 0.20	M1 = 0.29 P1 = 0.34 S1 = 0.24	0.60	0.90	0.87
Sat 001-01	DXi									
Sat 001-02	DX2									
Sat 001-03	DX2									

Result 3 - DXi submaster 001-00 suspends irrigation (valves are deactivated, and program runtimes continue to decrement) and starts diagnostic process.

DXi submaster 001-00 activates M1, verifies current is above maximum allowed, and deactivates M1.

DXi submaster 001-00 raises alarm 1139 "Master Valve maximum Current" and condemns M1.

DXi submaster 001-00 activates P1, verifies current is in range, and deactivates P1.

DXi submaster 001-00 activates S1, verifies current is in range, and deactivates S1.

DXi submaster 001-00 terminates automatic irrigation of program 1. Manual operations will not activate M1 until alarm is cleared. Automatic operations using M1 will be blocked from running until alarm is cleared.

Scenario 4 - DXi submaster 001-00 begins automatic irrigation operation of program 1 and program 2, by activating MV1, Pump1, station 1 then station 2. After station 2 is activated the measured current is below the minimum allowed current.

FLOW MAX Group	Satellite Type	Master Valves "ON"	Pumps "ON"	Station "ON"	Min Current	Nominal Current	Max Current	Total Min. Current	Total Measured Current	Total Max. Current
Sub 001-00	DXi	M1	P1	1, 2	M1 = 0.20 P1 = 0.25 S1 = 0.15 S2 = 0.16	M1 = 0.25 P1 = 0.30 S1 = 0.20 S2 = 0.21	M1 = 0.29 P1 = 0.34 S1 = 0.24 S2 = 0.25	0.76	0.7	1.12
Sat 001-01	DXi									
Sat 001-02	DX2									
Sat 001-03	DX2									

Result 4 - DXi submaster 001-00 suspends irrigation (valves are deactivated, and program runtimes continue to decrement) and starts diagnostic process.

DXi submaster 001-00 activates M1, verifies current is in range, and deactivates M1.

DXi submaster 001-00 activates P1, verifies current is in range, and deactivates P1.

DXi submaster 001-00 activates S1, verifies current is in range, and deactivates S1.

DXi submaster 001-00 activates S2, verifies current is below minimum allowed, and deactivates S2. DXi submaster 001-00 raises alarm 1121 "Station Minimum Current" and condemns S2.

DXi submaster 001-00 resumes automatic irrigation operation of program 1 and 2, for none condemned stations. Manual or automatic operations will not activate S2 until alarm is cleared.

Scenario 5 - DXi submaster 001-00 begins manual irrigation by activating MV1, Pump1 then Station 1. Next DXi satellite 001-01 begins manual irrigation by activating station 3. After station 3 is activated by DXi satellite 001-01 the measured current is below the minimum allowed current.

FLOW MAX Group	Satellite Type	Master Valves "ON"	Pumps "ON"	Station "ON"	Min Current	Nominal Current	Max Current	Total Min. Current	Total Measured Current	Total Max. Current
Sub 001-00	DXi	M1	P1	1	M1 = 0.20 P1 = 0.25 S1 = 0.15	M1 = 0.25 P1 = 0.30 S1 = 0.20	M1 = 0.29 P1 = 0.34 S1 = 0.24	0.6	0.75	0.87
Sat 001-01	DXi			3	S3 = 0.10	S3 = 0.15	S3 = 0.20	0.1	.09	0.2
Sat 001-02	DX2									
Sat 001-03	DX2									

Result 5 - DXi satellite 001-01 deactivates S3, raises alarm 1121 "Station Minimum Current" and condemns S3.

Manual or automatic operations by satellite 001-01, will not activate S3 until alarm is cleared.

Note, Irrigation at submaster 001-00 is not affected in this scenario.

Scenario 6 - DXi submaster 001-00 begins an automatic irrigation operation by activating MV1, Pump1 then station 1. Next DXi satellite 001-01 begins an automatic irrigation operation by activating station 3. Next the DXi submaster 001-00 measures current above the maximum allowed current.

FLOW MAX Group	Satellite Type	Master Valves "ON"	Pumps "ON"	Station "ON"	Min Current	Nominal Current	Max Current	Total Min. Current	Total Measured Current	Total Max. Current
Sub 001-00	DXi	M1	P1	1	M1 = 0.20 P1 = 0.25 S1 = 0.15	M1 = 0.25 P1 = 0.30 S1 = 0.20	M1 = 0.29 P1 = 0.34 S1 = 0.24	0.6	1.9	0.87
Sat 001-01	DXi			3	S3 = 0.10	S3 = 0.15	S3 = 0.20	0.1	.16	0.2
Sat 001-02	DX2									
Sat 001-03	DX2									

Result 6 - DXi submaster 001-00 suspends irrigation (valves are deactivated, and program runtimes continue to decrement) and starts diagnostic process.

DXi submaster 001-00 activates M1, verifies current is in range and deactivates M1.

DXi submaster 001-00 activates P1, verifies current is in range and deactivates P1.

DXi submaster 001-00 activates S1, verifies current is above maximum allowed and deactivates S1. DXi submaster 001-00 raises alarm 1120 "Station Maximum Current" and condemns S1.

DXi submaster 001-00 resumes automatic irrigation operation, for none condemned stations. Manual or automatic operations will not activate S1 until alarm is cleared.

Note, Irrigation at satellite 001-02 is not affected in this scenario.

Scenario 7 - DXi submaster 001-00 begins an automatic irrigation operation of program 3 by activating MV1, Pump1 then station 1. Next DX2 satellite 001-02 begins an automatic irrigation operation by activating station 4. Next the DXi submaster 001-00 measures current above the maximum allowed current.

FLOW MAX Group	Satellite Type	Master Valves "ON"	Pumps "ON"	Station "ON"	Min Current	Nominal Current	Max Current	Total Min. Current	Total Measured Current	Total Max. Current
Sub 001-00	DXi	M1	P1	1	M1 = 0.20 P1 = 0.25 S1 = 0.15	M1 = 0.25 P1 = 0.30 S1 = 0.20	M1 = 0.29 P1 = 0.34 S1 = 0.24	0.6	0.1	0.87
Sat 001-01	DXi									
Sat 001-02	DX2			4	S3 = 0.10	S3 = 0.15	S3 = 0.20	0.1	.16	0.2
Sat 001-03	DX2									

Result 7 - DXi submaster 001-00 suspends irrigation (valves are deactivated, and program runtimes continue to decrement) and starts diagnostic process.

DXi submaster 001-00 activates M1, verifies current is in range and deactivates M1.

DXi submaster 001-00 activates P1, verifies current is above maximum allowed and deactivates P1.

DXi submaster 001-00 raises alarm 1141 "Pump Maximum Current" and condemns P1.

DXi submaster 001-00 activates S1, verifies current is in range and deactivates S1.

DXi submaster 001-00 terminates automatic irrigation of program 3. Manual operations will not activate P1 until alarm is cleared. Automatic operations using P1 will be blocked from running until alarm is cleared.

Note, Irrigation at satellite 001-02 is not affected in this scenario.

Scenario 8 - DXi submaster 001-00 begins an automatic irrigation operation of program 9 by activating MV1, Pump1 then station 1. Next DX2 satellite 001-02 begins an automatic irrigation operation of program 5 by activating station 4. After station 4 is activated by DX2 satellite 001-02 the measured current is below the minimum allowed current.

FLOW MAX Group	Satellite Type	Master Valves "ON"	Pumps "ON"	Station "ON"	Min Current	Nominal Current	Max Current	Total Min. Current	Total Measured Current	Total Max. Current
Sub 001-00	DXi	M1	P1	1	M1 = 0.20 P1 = 0.25 S1 = 0.15	M1 = 0.25 P1 = 0.30 S1 = 0.20	M1 = 0.29 P1 = 0.34 S1 = 0.24	0.6	0.75	0.87
Sat 001-01	DXi									
Sat 001-02	DX2			4	S3 = 0.10	S3 = 0.15	S3 = 0.20	0.1	.09	0.2
Sat 001-03	DX2									

Result 8 - DX2 satellite 001-02 deactivates S4, raises alarm 1005 "I Low Limit", and condemns S4.

DX2 satellite 001-02 resumes automatic irrigation operation of program 5, for none condemned stations. Manual or automatic operations will not activate S4 until alarm is cleared

Note, Irrigation at submaster 001-00 is not affected in this scenario.

Scenario 9 - DXi submaster 001-00 begins an automatic irrigation operation of program 8 by activating station 1. Next DX2 satellite 001-02 begins an automatic irrigation operation of program 6 by activating MV1, Pump1 then station 4. After station 4 is activated by DX2 satellite 001-02 the measured current is above the maximum allowed current.

FLOW MAX Group	Satellite Type	Master Valves "ON"	Pumps "ON"	Station "ON"	Min Current	Nominal Current	Max Current	Total Min. Current	Total Measured Current	Total Max. Current
Sub 001-00	DXi			1	S1 = 0.15	S1 = 0.20	S1 = 0.24	0.15	0.2	0.24
Sat 001-01	DXi									
Sat 001-02	DX2	M1	P1	4	M1 = 0.20 P1 = 0.25 S1 = 0.15	M1 = 0.25 P1 = 0.30 S1 = 0.20	M1 = 0.29 P1 = 0.34 S1 = 0.24	0.6	1	0.87
Sat 001-03	DX2									

Result 9 - DX2 satellite 001-02 deactivates S4, raises alarm 1004 "I High Limit", and condemns S4.

DX2 satellite 001-02 resumes automatic irrigation operation of program 6, for none condemned stations. Manual or automatic operations will not activate S4 until alarm is cleared

Note, Irrigation at submaster 001-00 is not affected in this scenario.

Note, DX2 controllers can't run diagnostic or condemn Master Valves or Pumps.

Appendix D: Setting Up a FLOW MAX System

Flow Max is a unique feature specifically designed to manage multiple DXi controllers which share a common water source. Flow Max systems intelligently share resources and manage operations for satellites utilizing a single point of connection (POC). The shared resources may include up to two common pumps, up to three Flow Meters, and up to three Master Valves.

Figure D-1: Flow Max Hardwire Configuration illustrates a typical installation.



The Flow Max feature is not applicable for controllers which have exclusive use of its water source (as in, one point of connection (POC) per controller). Please refer to **Appendix B: Flow Meters** whenever flow and flow control is required for a single controller installation.

Flow Max utilizes the intelligence of DXi field satellite controllers to provide the following features:

- Operation of shared Master Valves, Pump or Flow Meters across controllers without the need for peripheral relays or complex wiring.
- Shared devices may be wired in the conventional fashion to the nearest controller.
- Dynamic adjustment/validation of station flow limits as stations turn on and off anywhere in the system.
- Detection of system main line breaks.
- Detection of system unscheduled flow.
- Ability to read the flow GPM rates at any of the Flow Max participant

controllers.

- Automatic establishment of flow limits and current limits for all the controllers in the system.
- Automatic system protection for the shared pump in partial power outages or communication failures.
- Automatic generation of diagnostic system warning messages at each Flow Max unit.
- Dynamic real time monitor shows system status at all times.

Overview

A Flow Max system is comprised of a number of identical DXi controllers (typically 3 to 5) with the first controller set up as the submaster and the remaining units set up as satellites.

Controllers that share any Pump, Master Valve or Flow Sensor are defined as Flow Max participants. As Flow Max participants, the DXi controllers must be part of a serial hardwire configuration. Controllers that are not Flow Max participants may reside on the hardwire link but must be defined as nonparticipants.

The serial hardwire configuration requires a communications cable (EV-CAB-COM).

Flow Max provides a means to detect station flow limits and main line breaks within design and programming limitations.

All controllers participating within a Flow Max system must be programmed as Flow Max participants from each of their respective control panels.

Submaster

The Submaster controller in the Flow Max group is the watchdog for the entire group. It monitors all participant device operations such as pumps and master valves. It also issues corrective action for flow violations, maintains the communication link status with the Central, and accumulates all flow related data. The Submaster allows the user to review all pertinent shared device information from its control panel. The user can also monitor real time activity such as measured flow, upper and lower limit changes as stations transition, as well as flow delay status.

The Submaster allows flow limits and current limits for each station of all participant controllers to be established automatically from one location.



Flow Max system satellites can be set to use Cloud Connect to communicate so that they can be operated using the Rain Master irrigation smartphone app, ProMax Connect. If that is the case, note that the Central computer may communicate with the satellites directly, bypassing the Submaster.

Devices

The devices in a Flow Max system are defined as follows:

- Master Valves 1, 2, and 3
- Pumps 1 and 2
- Flow Meters 1, 2, and 3

Flow Max allows any participant controller to utilize a shared device. When a Flow Max participant program reaches its "Start Time," the Submaster initiates a command to turn the device on. The device will remain on provided there is at least one program running that has been set up to share the use of the device.

Shared devices may be connected to any Flow Max participant controller. Each device connection is made to one and only one controller. All other participant controllers that share the use of the device must be programmed at the respective controller to select the appropriate option.

The Master Valve, Pump, and Flow Meter devices are physically connected to the respective controller Master Valve Power Board. Flow Meter installation instructions are included with the optional Flow Sensor kit.

Flow Sensors

Flow sensor operation must include the calibration factors of "K" and "Offset" values for accurate calculations. These values are required to compensate for the differences between pipe size and flow sensor used. Complete tables on K and Offset values are given in **Appendix B: Flow Meters**.

The satellite controllers that are physically connected to flow sensors must have the "K" and "OFFSET" values for the particular flow sensor programmed.

Each point of connection for a MV, Pump or Flow Sensor must be defined at the controller it's connected too. The selection is made under menu Setup -> FLOWmax, "devices connected to this clock".

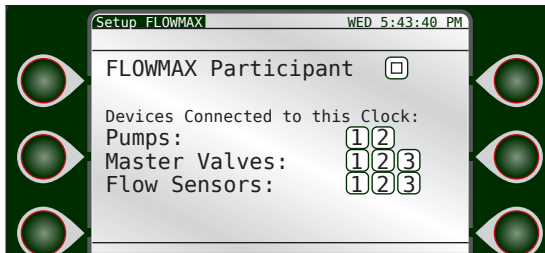

Flow Check Delay

The Flow Check Delay provides a specified amount of time before any limit comparisons or corrective action is taken by the system. This allows water lines and pressures to stabilize after station turn on and turn off transitions.

The system has the default flow check delay of two minutes.

When a station turns on, flow measurement begins immediately; however, the limits will not be checked or reacted upon until the first reading after the flow check delay has completed. Keep in mind, that the more station transitions that occur within the group of Flow Max participants, the more limits will go un-checked.

Main Line Limits

For any number of controllers within a Flow Max group, there will only be one Main Flow Limit. Remember that the main flow limit must be higher than an expected flow

under normal operation yet low enough to react when a main break line occurs.

Main Line Limit settings must be made at the submaster for a FLOWMAX group, regardless of where the point of connection is. Each participating controller in the FLOWMAX group will be held to submaster Main Line Limit settings. (Same for Unscheduled flow.) Main Line Limit settings set at satellites in a FLOWMAX group will be ignored.

Flow Max Limitations

Although the number of controllers in a Flow Max system is not limited, the higher the number of participants, the less control there is to detect problems.

Assume a total of five controllers in a Flow Max group with all five controller programs running simultaneously. Each of the five programs operating has stations that under normal conditions use 100 Gallons Per Minute to irrigate. Each station allows for a 10% Upper Limit Tolerance. With a 10% tolerance, a station normally using 100 GPM would be allowed a maximum flow of 110 GPM before causing an alarm. With five stations operating under the same conditions, Flow Max, which sums all limits, will allow a maximum flow of 550 GPM before causing an alarm for a station upper limit violation. This means that a broken head would require a 50 GPM measurable difference before causing an alarm, not a 10 GPM difference, which would be the case if only one station had been operating.

Under the conditions above, normal operating flow would be 500 GPM with station limits allowing up to 550 GPM. The main flow limit must be higher than 550 GPM. The question is, does a main line break yield more than 550 GPM? That's where programming and scheduling can accommodate the ability to keep the main limit within an amount detectable by a real break.

Physical Configuration

The Hardwire Link provides the communication among all controllers of a standard irrigation system and/or a Flow Max system. All units are connected in a series configuration using direct burial EV-CAB-COM twin axial cable (sold separately). The Hardwire Link provides reliable communication among the controllers at distances up to several thousand feet.

Figure D-1: Flow Max Hardwire Configuration illustrates a typical wiring configuration for a 3 controller system.

System configurations that include the Central Control Computer will require the submaster controller to operate with either a wireless communication board (radio, cellular, WiFi), a direct serial connection, or and Ethernet connection.

The following pictorial diagrams of Figures 1, 2 and 3 illustrate the wiring detail and connections of a typical system configuration:

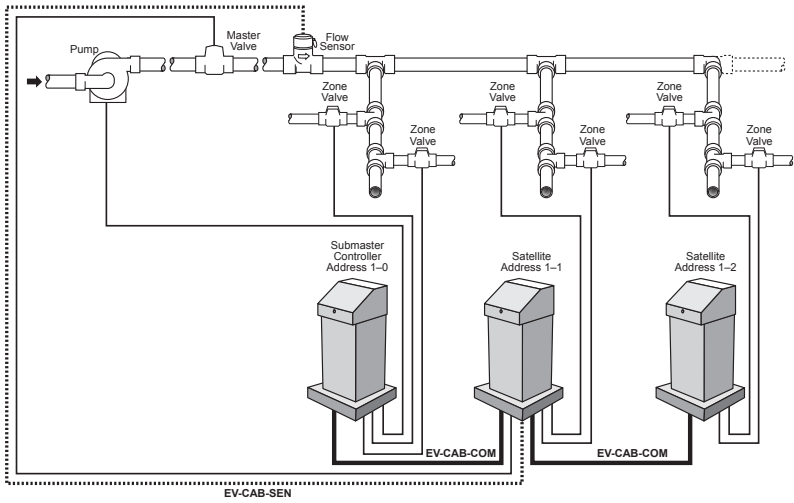

Figure D-1: Flow Max Hardwire Configuration

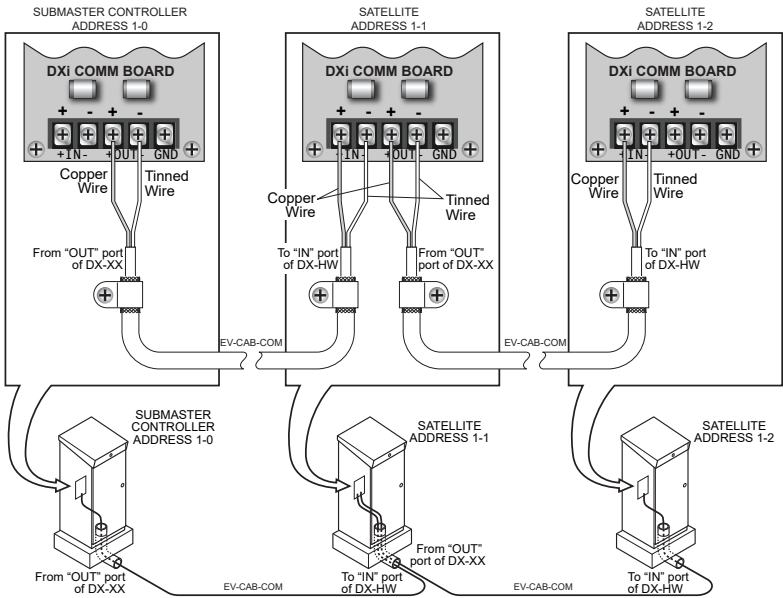

Figure D-2: Detailed Hardwire Connections

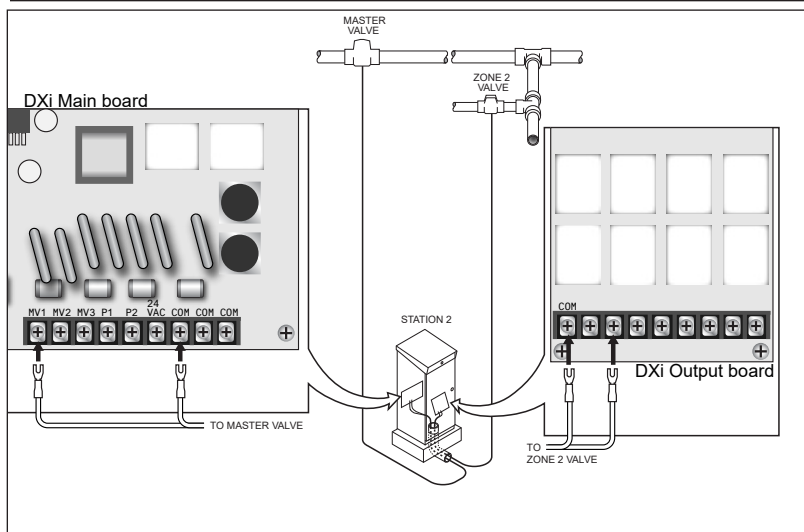

Figure D-3: Detailed Master Valve and Station Connections

Master Valve/Pump Configuration

The Master Valve or Pump may be physically connected to any controller of the system, which is then shared by the remaining controller units. Any given valve/pump may be physically connected to only one controller.

The Master Valve Power Board supplies the power and control for the Master Valves and Pump. Every controller is equipped with this board assembly, providing the ability to connect any given valve/pump to any controller. Connections are made to the screw terminals as depicted in Figure E-3. One wire of the valve/pump connects to its associated terminal and the other (common) wire connects to the COM terminal.

Flow Max Setup Procedure

The following section details the programming required in order to setup a Flow Max configuration. Programming must be performed at all controllers that will be part of the Flow Max system.

A typical Flow Max setup includes the following:

Submaster:

- Submaster Address Entry
- Participant Selection / Devices Connected to this Clock
- Include in Total Flow
- Flow Meter K and Offset Values (if connected to this satellite)
- Station Number and Valve/Pump Assignments
- Unscheduled Flow Limits
- Main Line Limit
- Monthly Limit
- Flow Limit Checking

Satellite (Non-Participant):

- Non-participant selection

Satellite (Participant):

- Participant selection /Devices Connected to this Clock
- Include in Total Flow
- Flow Meter K and Offset Values (if connected to this satellite)

This procedure utilizes the configuration depicted in **Figure D-1: Hardware Configuration** with a submaster address of 1-0. The figure illustrates a system consisting of three controllers, a Pump, one Master Valve and one 2-inch Flow Sensor. The Pump is physically connected to the submaster. The Master Valve and Flow Sensor are physically connected to satellite with the address 1-1. **Table 1: Flow Max Sample Worksheet** lists the parameters for each controller.

Submaster Setup Procedure

1. At the designated submaster controller, go to **Setup-->Communication**.

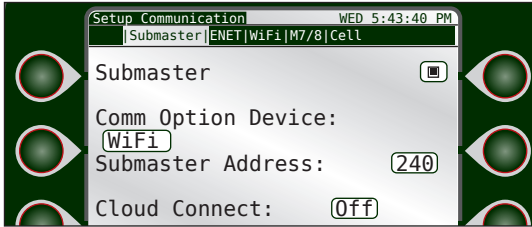

2.  to turn on Submaster.
3. Use the Control Dial to set **Submaster Address**.
4. Now go to **Setup-->Flow Max**.

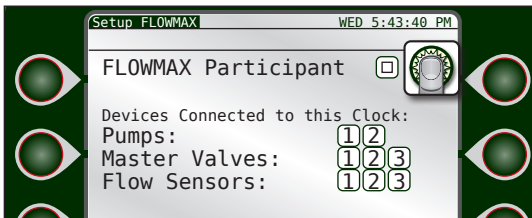

5. Check the **FLOW MAX Participant** checkbox.
6. Using the Control Dial, select the devices which are connected to this Clock. This includes up to two pumps, three master valves, and three flow sensors. For this example, select Pump 1.



Selections made here will allow flow tracking and statistical gathering for reporting and diagnostics.

This completes the Submaster Setup procedure from the satellite.

Flow Max Flow Limits

In a Flow max system, the settings that reside in the Submaster (regardless of point of connection) will control Main Line Limit, Unscheduled Flow Limit, Flow Check Delay, Monthly Limit, and Flow Checking Enabled. The total GPM for all participating controllers is calculated into the overall Main Line Flow Limit value. The Main Line Flow Limit is entered at the submaster controller only. For any number of controllers within a Flow Max group, there will only be one Main Line Flow Limit.

Remember that the Main Line Flow Limit must be higher than an expected flow under normal operation yet low enough to react when a main break occurs.

Set the Main Line Flow Limits

1. At the submaster controller, go to **Setup-->Flow-->Flow Options**.
2. Use the Control Dial to enter the appropriate **Main Line Limit** value.



to set.

- We have to set the **Unscheduled Limit** too. Use the Control Dial to enter the **Unscheduled Flow** field and enter an appropriate value.  to set.

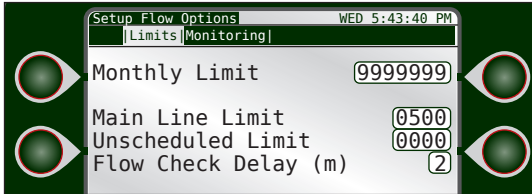

This completes the Flow Max Flow Limits setup procedure at the submaster.

Remember to have the Monthly Limit, Flow Check Delay, and Flow Checking enabled.

Satellite Controllers

The remaining two Satellite Controllers in Figure D-1 may be configured to either of the two following options:

- Non-participant Satellite - NOT part of the Flow Max system.
- Participant Satellite - Part of the FlowMax system utilizing one or more shared devices.

For a Non-participant Satellite

- At the non-participant satellite, go to **Setup-->Flow Max**.
- Be sure **FLOW MAX Participant** is unchecked.



This step does not apply to our sample procedure.

For a Participant Satellite, not directly connected to shared device/s (Figure D-1, Satellite 1-2)

- At the participant satellite, go to **Setup-->Flow Max**.
- Be sure **FLOW MAX Participant** is checked.
- Entering K and Offset values is not required for this satellite.

Participant Satellite, directly connected to shared device/s (Figure D-1, Satellite 1-1)

1. At the participant satellite, go to **Setup-->Flow Max**.
2. Be sure **FLOW MAX Participant** is checked.
3. Select the devices that are connected to this clock. In this example, that would be Master Valve 1 and Flow Sensor 1.
4. Go to **Setup-->Flow-->Flow Sensors**.
Enter K and OFFSET values.

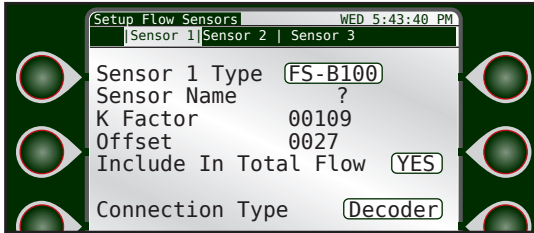

For further information on K VALUE and OFFSET, refer to **Appendix B: Flow Meters**.

5. Be sure **Include in Total Flow** is set to **YES**.
Repeat the programming steps above for any remaining satellites as necessary (as in, not part of this example).

Once all the participants have been programmed with the Flow Max configuration data:

- Program each satellite with the desired irrigation program(s).



Insure the program(s) have been set up properly for usage of a Master Valve and/or Pump.

- Flow limits must be established for all stations in the system.
Flow limits can be established using the **Learn Flow/Current** feature.

This completes the Setup procedure for the satellite controllers.

Flow Max Worksheet

The Flow Max worksheet lists all parameters for the example Flow Max configuration. This table may serve as a guide to setting up your own Flow Max system.

Sample Worksheet

Menu Function	Submaster	Controller 1	Controller 2
Address	1-0	1-1	1-2
FLOW MAX Participant	yes	yes	yes
Flow Meter 1	no	yes	no
Flow Meter 2	no	no	no
Pump	yes	no	no
MV1	no	yes	no
MV2	no	no	no
MV3	no	no	no
K/Offset Value	no	yes	no
Flow Station Limits	yes	yes	yes
Main Limits	yes	no	no
Monthly Limit	yes	no	no
Flow Check Delay	yes	no	no
Flow Low Limit Checking	yes	no	no
Flow High Limit Checking	yes	no	no
Unscheduled Limit	yes	no	no
Non-participant	no	no	no
Include in Total Flow	no	no	no
Device connection	no	yes (sensor present)	no

Blank Worksheet

Menu Function	Submaster	Controller 1	Controller 2	Controller 3
Address				
Share Flow, Pump, and MV				
Flow Meter 1				
Flow Meter 2				
Pump				
MV1				
MV2				
MV3				
K/Offset Value				
Flow Limits				
Main Limits				
Monthly Limit				
Flow Check Delay				
Flow Low Limit Checking				
Flow High Limit Checking				
Unscheduled Limit				
Non-participant				
Include in Total Flow				
Device connection				

Flow Max Diagram

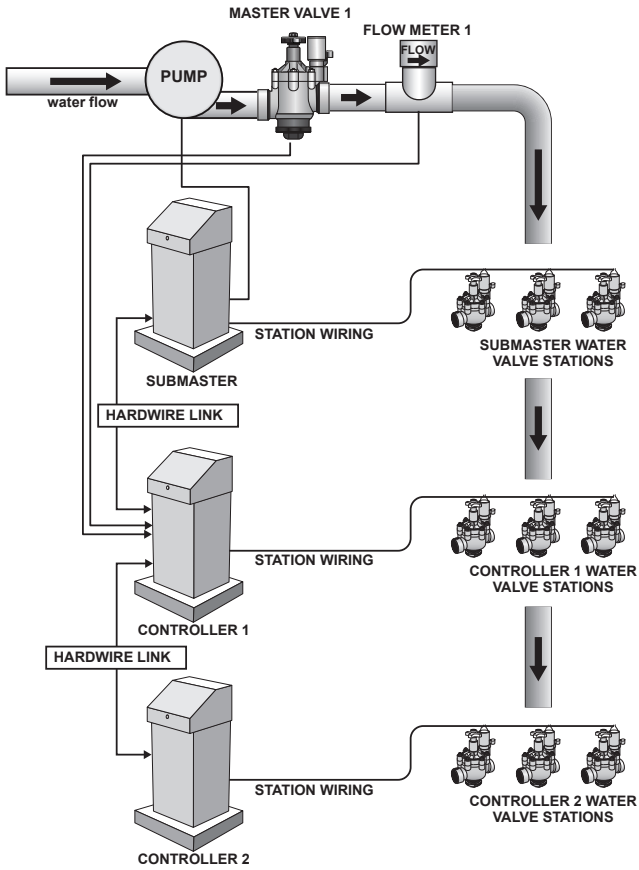

Flow Max Diagnostic Tools

Real Time Flow Monitor

A Real Time Flow Monitor is available at the submaster controller of a Flow Max system. This tool provides a wealth of information about the operational status of the system. The real time monitor can be started and run in the background as the system is running.

Procedure

Go to Reports-->Water Usage-->Flow Rates.

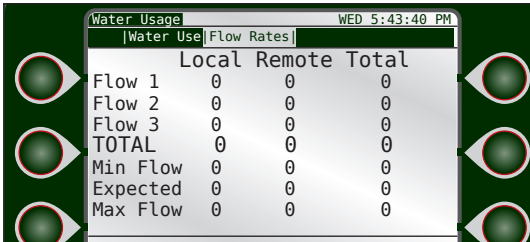

Water Usage		WED 5:43:40 PM		
Water Use Flow Rates				
	Local	Remote	Total	
Flow 1	0	0	0	
Flow 2	0	0	0	
Flow 3	0	0	0	
TOTAL	0	0	0	
Min Flow	0	0	0	
Expected	0	0	0	
Max Flow	0	0	0	

The Flow Rates screen updates continuously and displays:

- Flow from Flow Sensors.
- Total Flow
- The dynamic flow upper limit (UL), changes whenever stations at any controller transition On or Off
- The dynamic flow lower limit (L), changes whenever stations at any controller transition On or Off
- The status of whether the submaster is in Flow Delay (FD) mode. If "FD" appears on the second line of the display this indicates that flow delay is in effect, hence limits are not being checked. The absence of "FD" from the display means that the measured flow is being checked against the displayed limits.

The Real Time Flow Monitor is a useful tool for verifying that the proper flow delay has been programmed for the system. Flow readings should stabilize a minimum of 20 to 30 seconds prior to the "FD" removal from the display. This should provide adequate margin when programming this parameter.

In addition to the submaster capabilities, each participant controller of the Flow Max system can display the measured flow. Flow is monitored at the Flow Max participant using the same key sequence as at the submaster.

Review Flow Max Physical Configuration

The Flow Max physical configuration can be reviewed after it has been entered into all Flow Max participants. The review capability is available at the submaster only.

Devices

From the Setup menu:

Reports & Diagnostics --> Diagnostics -->



to Communication screen --> FLOW MAX Comm -->

to Devices

This screen shows all the devices attached to the Flow Max submaster and satellites, as well as flow measurements and whether or not the device (MV or pump) is On or Off.

Comm

The Comm screen displays communication information as well as the amount of time since the last successful communication.

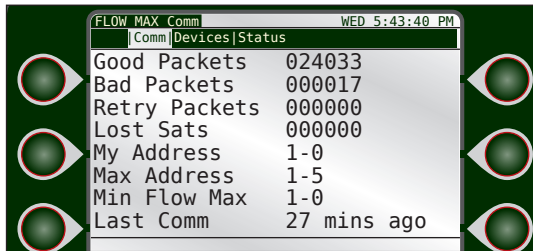

Status

The Status screen displays the alert condition settings that will stop irrigation activity, such as a mainflow violation, unscheduled flow, etc.

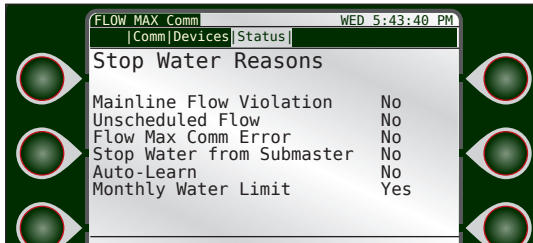

This completes the Flow Max REVIEW ALL procedure.

Flow Max Warnings and Exception Conditions

All warnings referenced in this section are described fully in **Chapter 8: Alerts**. Please refer to that section for details. Most exception conditions result in warnings being generated at the submaster as well as each Flow Max participant.

Different information however will appear at different controller locations depending upon the circumstances.

Flow Max Lower Limit Violation

The submaster has determined that the measured flow from the flow meter(s) is less than the expected flow. All station run times associated with the (low) flow reading will be terminated. Programs automatically advance to their next scheduled station.

Flow Max Upper Limit Violation

The submaster has determined that the measured flow from the flow meters(s) is greater than the expected flow. All station run times associated with the (high) flow reading will be terminated. Programs automatically advance to their next scheduled station.

Flow Max Communications Failure

The hardwire data communications between the submaster and one or more satellites has been lost or interrupted. This may be indicative of a failure of the communications cable which runs to/from each satellite in a Flow Max configuration. All irrigation is terminated.

Flow Max Main Flow

The main line limit for the Flow Max system has been exceeded. All irrigation is terminated and all future scheduled irrigation will be inhibited.

Flow Max Unscheduled Flow

Flow was detected but no controllers within the system had any stations which were turned on. The normally open master valve will be energized and all future scheduled irrigation will be inhibited.

Appendix E: Hardwired Communication Troubleshooting

Toro® DXi controllers are capable of communication between controllers to allow sharing of flow devices, Master Valves, pumps, as well as communication to Laguna central software. Controllers share communication via a hardwired connection. The hardwired communication is made via the EV-CAB-COMM cable due to its specific direct burial and communication properties. Each controller is wired in a daisy-chain configuration with the submaster being the starting point and the last controller being the ending point. Controller-to-controller connections are made via the "DXi COMM BOARD" as seen below in figure D-2.

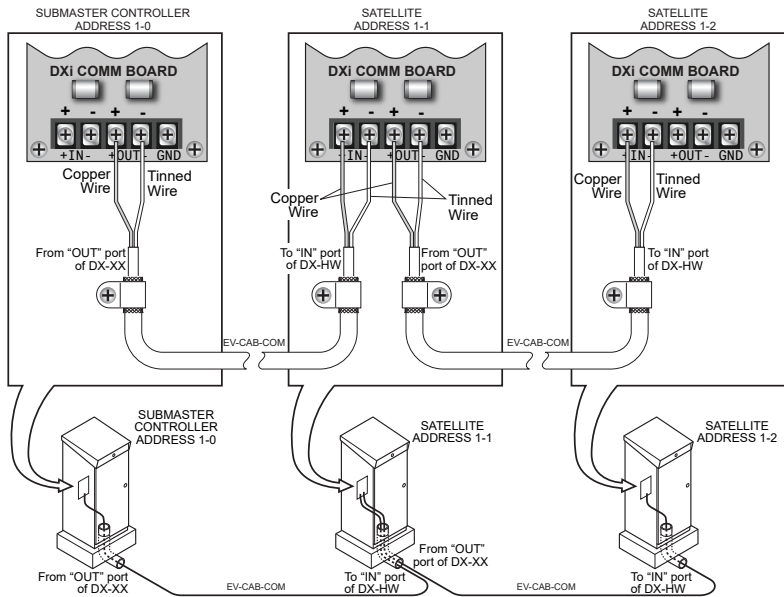

DXi COMM BOARD: The DXi-COM-BOARD is seen below in figures 1 and 2. The board has LED indications for 5V and 12V power, and data traffic via the R (Receive), T (Transmit), and D (Direction) LED's. The board has designated inputs for communication coming "IN" from an upstream controller and "OUT" to a downstream controller. Each "IN" and "OUT" port has a polarity indication, "+" or "-" as well.

Normal Operating Behavior:

Indication LEDs

The indication LED's can be used to quickly diagnose normal operating behavior of a hardwired connected DXi controller group. The 12V and 5V indication LED's should have constant solid illumination. The R, T, and D LED's will pulse illumination in a semi constant repeated pattern. Under normal operating conditions this sequence will repeat approx. every 1-2 seconds.

The T or R LED should pulse rapidly, if they stay solidly illuminated for longer than approx. 5 seconds, this is not typical behavior and the connections, field wiring and/or hardware should be inspected.

The D LED should pulse rapidly, like the T or R LED, but will hold it's illuminated state slightly longer. If the D LED stays solidly illuminated for longer than approx. 5 seconds, this is not typical behavior and the connections, field wiring and/or hardware should be inspected.

Note: The T, R, or D LEDs will be illuminated for the longest period of time when Laguna central software is communicating to a controller group.

Alerts

Under normal operating conditions a controller group should not experience HW communication related alerts. Generation of any of the alerts below in Table 1, is a sign of a problem, and connections, field wiring and/or hardware should be inspected.

Alarm Name	Laguna Code	Description	Data
Satellite Offline	1112	Satellite lost communication with submaster	- Time stamp of the violation
Satellite Online	1113	Satellite established communication with submaster	- Time stamp of the violation
HW Communication Failure	1114	Submaster lost communication with satellite	- Satellite(s) address of communication loss - Time stamp of the violation

Please note, if maintenance is being performed on a controller or a controller is powered down in a group, this will result in generation of communication related alerts.

Communication with Laguna Central Software

Communication with central software should be robust, especially for submasters communicating to Laguna via an Ethernet LAN connection. Wireless communication to Laguna from the submaster will be subject to errors and retries, especially compared to Ethernet LAN. Bottom line, no one controller in a hardwired group should experience an excess of communication failures compared to the other controllers in the group. If a specific controller in a controller group fails more, in comparison to the others, this is not normal operational behavior and connections, field wiring and/or hardware should be inspected.

Diagnostic View

The DXi controller provides a useful diagnostic screen to triage and gauge controller-to-controller communication health. The diagnostic screen can be accessed by navigating to, Main Menu -> Reports & Diagnostics -> FLOWMAX and is shown below in figure 3.

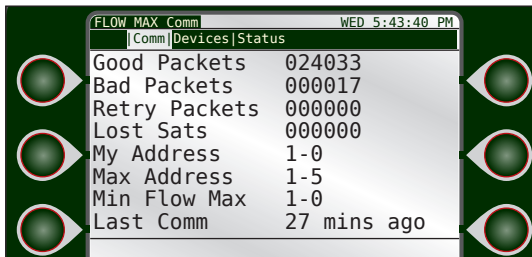

FLOW_MAX_Comm		WED 5:43:40 PM
Comm	Devices	Status
Good Packets	024033	
Bad Packets	000017	
Retry Packets	000000	
Lost Sats	000000	
My Address	1-0	
Max Address	1-5	
Min Flow Max	1-0	
Last Comm	27 mins ago	

Initiate a large communication (Statistics Upload or Program Upload/Download all Satellites) from Laguna Central Software to the suspect controller and monitor the diagnostic screen for 'Bad Packets' and 'Retry Packets'. If 'Bad Packets' and/or 'Retry Packets' are being generated as a result of the central communication, this is not normal operational behavior, and connections, field wiring and/or hardware should be inspected.

Controller Address Generation

Under normal operating conditions all downstream controllers wired to the submaster should be provided an address by the submaster. For Example, if the submaster uses address 001-00, the next controller downstream will be given address 001-01 and it will be displayed on the UI. Each successive downstream controller will be incremented by 1 (001-02, 001-03 ...). If any downstream controller reverts to its default address of 239-239, this is not normal operational behavior, and connections, field wiring and/or hardware should be inspected.

Inspecting Field Wiring:

Field wiring problem causes vary, but all typically result in a few types of failures, such as additional resistance, open circuit, short circuit and/or ground leakage.

Typical causes for these failures are a severed wire, poor/defective wire splice, defective wire insulator, water ingress or installation of the incorrect/poor quality underground communication cable. To test for these faults, try the following:

Test 1

Run a new communication cable above ground to the suspect controller. Exercise large communication to the controller from Laguna and monitor the controller communication diagnostic screen, communication board indication LEDs and generation of communication alerts.

Failure to observe normal operating behavior is indicative of a bad hardware module or inter hardware ribbon connectors (not a field wiring issue).

Test 2

Power down the suspect controller, upstream controller and downstream controller. Disconnect the communication cable from the suspect control. Connect the "IN" positive and negative wires together. Connect the "OUT" positive and negative wires together.

Disconnect the "OUT" communication cables from the upstream controller and probe resistance with multi-meter. Disconnect the "IN" communication cables from the downstream controller and probe resistance with multi-meter.

The resistance value probed for the "IN" and "OUT" lines should be proportional to the total field wire length run. EV-CAB-COMM has a resistance of 0.0333 Ohms/Meter. If the total wire length (up and back), is 250 meters, this should yield a resistance value of approx. 8 ohms ($0.0333 \text{ ohm/meter} * 250 \text{ meters} = 8 \text{ ohms}$).

A higher than expected resistance value is indicative of poor splices or incorrect/poor quality cable.

An extremely high or open circuit value is indicative of a severed wire.

A lower than expected resistance value is indicative of a shorted wire.

Test 3

Power down the suspect controller, upstream controller and downstream controller. Disconnect the communication cable from the suspect controller, for both the "IN" and "OUT" connections.

Using a multi meter, make a resistance measurement between the disconnected "IN +" field wire and the enclosure chassis. Repeat the resistance measurement for the "IN -", "OUT +", and "OUT -" with respect to the chassis.

The resistance values measured can range depending on the communication type, enclosure type and EV-CAB-COMM wire shield grounding. Valid Approx. measurement values for this test are:

OUT- \approx 3.1K ohm, Mega ohms or Open Circuit

OUT+ \approx 3.2K ohm

IN- \approx 3.1K ohm, Mega ohms or Open Circuit

IN+ \approx 3.2K ohm

A lower than expected resistance value for any of the measurements in Test 3, are indicative of a ground leak or short in the communication wire. Additionally, resistance values greater than 4K ohm but less than 1Mega ohm are suspect of ground leaks.

Test 4

Power down the suspect controller, upstream controller and downstream controller. Disconnect the communication cable from the suspect controller, for both the "IN" and "OUT" connections.

Using a multi meter, make a resistance measurement between the disconnected "IN +" and "IN -" field wire. Repeat the resistance measurement for the "OUT +" and "OUT -" field wire.

The resistance value for the two measurements should be approx. 255 ohms.

A lower than expected resistance value are indicative of a ground leak short in the communication wire.

A higher than expected resistance value is indicative of poor splices or incorrect/poor quality cable.

An extremely high or open circuit value is indicative of a severed wire.

Test 5

Swap DXi-COM-BOARD, Timer Module (aka TM), and Interfacing cable between TM and COM board with known good hardware for both the suspect controller and upstream controller. Disconnect the communication cable "OUT" connections, if any, of the suspect controller.

Exercise large communication to the controller from Laguna and monitor the controller communication diagnostic screen, communication board indication LEDs, and generation of communication alerts.

Failure to observe normal operating behavior is indicative of a field wiring issue.

Appendix F: Grounding the Communication Cable

In this appendix, we cover grounding the DX3 / DXi communication cable. Adequate grounding for the communication cable is essential.

The cable connecting each DX3 / DXi controller (part number EV-CAB-COMM) contains one twisted pair and one mesh outer shield. By exposing the twisting the mesh shield (see **Prepping the Communications Cable** below), it can serve as the ground connection between controllers. The ground connection can be attached to:

- the GND input on the DX Comm board (Method 1 - one ground wire only)
- grounding screw/s mounted in the chassis (Methods 2 and 3).

Prepping the Communications Cable

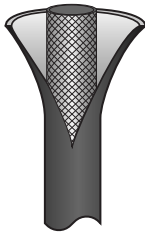

1) Slice outer jacket of COM wire to reveal wire mesh.

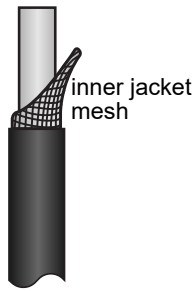

2) Trim away outer layer. Twist mesh to form ground wire.

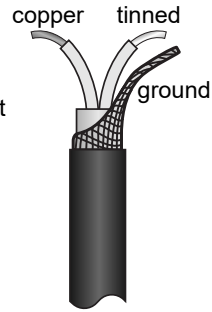

3) Trim inner jacket to expose copper and tinned wires.

Method 1 - Ground to Comm Board

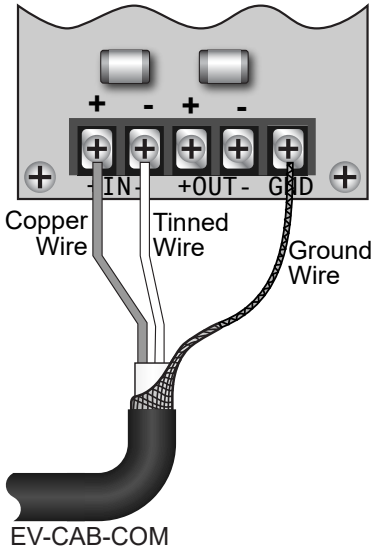

Method 2 - Ground to Ground Screw

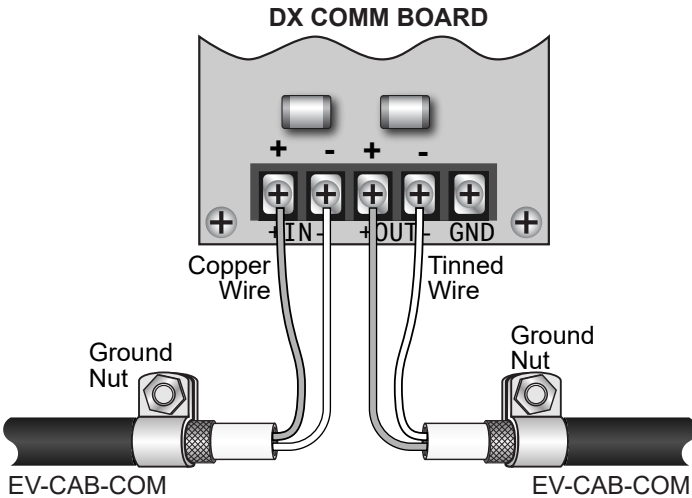

NOTE: For methods 2 and 3, ground nut screws might have to be added by drilling holes in the controller chassis. See “Prepping the Chassis”, page 142, for complete instructions.

Method 3 - Two COM wires ground to Ground Screw

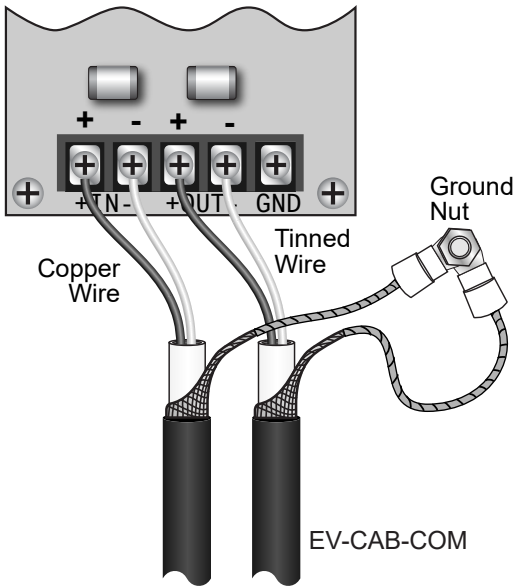

Splicing COM Ground Wires

It is possible to splice two COM wires together. Be sure to splice the ground wires together as well.

Spliced ground wires can be terminated in a ground nut.

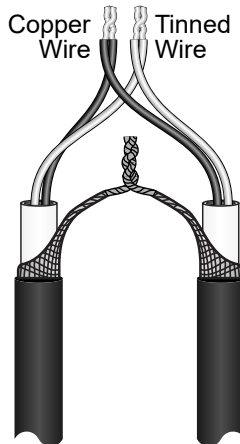

Prepping the Chassis

Methods 2 and 3 might require installing a ground nut into the controller chassis. Follow these directions carefully to ensure grounding and chassis water rating are not compromised.

1. Drill hole location. The ground nut should be installed within 12 cm of the terminal blocks of the DX output board. On the interior, the drill hole should be as unobstructed and clear of interior cards and cables as possible.
2. Drill a 1/4" hole. Have on hand a stainless-steel flathead machine screw (1/4-20) x 3/4" that engages at least two full threads.
3. Use the diagram, right, to install the screw and the various washers, lock washers, ring terminals, and nuts.

To crimp the ground wires into the ring terminals, follow **Ring Terminal** instructions, right.



Be sure that washers are installed on both sides of the chassis wall to ensure water cannot ingress.

4. Secure ring terminals with washer, lock washer, and lock nut.

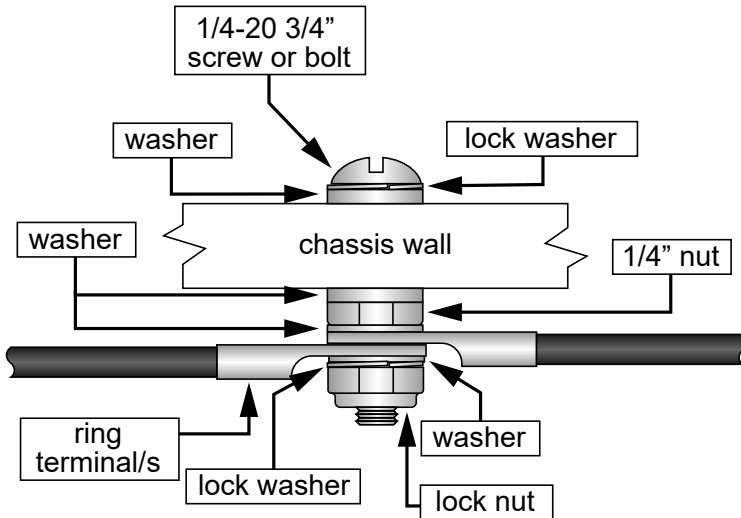

Ring Terminal Specifications

Part number: 415-0210: MPN 711K818

Crimping Instructions:

1. Mount the terminal on a threaded screw or stud for a secure connection.
2. Use a wire crimper (McMaster part 7289K1 or similar) to fasten ground leads to wire. Place crimp end into the die of the tool with ground leads passing through. Apply pressure on the crimp until ground leads are securely fastened into the crimping end of the terminal.

Glossary

Alert / Alarm

An irrigation related "event" reported by the controller which requires operator notification and/or action.

Central Control Mode

Central Control Mode indicates that two way communications have been established between the DXi controller and the Central Control PC. This means that programming data can be downloaded and uploaded, and that the Central Control PC can control all functions remotely. Central Control Mode can be entered in two ways:

1. If a controller has been setup as a submaster and a valid address has been entered.
2. If the controller is physically connected as a satellite and has established two-way communications with its submaster.

Condemned Station

A station that shut down due to operational defects or exceeded limits. The condemned station will not operate again until the defects are corrected and warnings are cleared.

Continuous Cycle

A watering program that will run continuously within a user defined water window. After the first cycle, a specified soak time is enforced before the program starts again.

Controller

A microprocessor based solid state programmable apparatus that automatically controls and manages irrigation valves, pumps, flow sensors and other peripheral

devices. The term is used interchangeably with "satellite".

Controller Address

Identifies each controller/satellite within a multiple controller system. The address number is alternately displayed on the base screen with the program number.

Current Limits

The maximum amount of current that a station is allowed to draw. If the specified maximum current is exceeded, the station will shut down and the program advances to the next station. Also refers to the minimum amount of current that a station should be drawing. If a station output does not draw any current, it is likely that the circuit is open.

Cycle Mode

Option that selects either start times or continuous cycle.

Device

Defined in an irrigation system configuration as a Master Valve, Pump or Flow Sensor.

Decoder

A device on the 2-Wire path that activates solenoids based off commands from a controller. Depending on the decoder type it can activate stations, MV's, Pumps, read flow sensors or read moisture sensors.

EvapoTranspiration (ET)

The name reflects two ways water moves from an irrigated field to the atmosphere: Evaporation, which is the movement of water from the wet soil to the air, and Transpiration which is the movement of water from the plant to the air.

EV-CAB-COM

A particular type of communication cable used in controller hardwire configurations.

EV-CAB-SEN

A particular type of cable for sensor connections to a controller.

Field Wiring

The wiring setup among controllers, Master Valves, Pumps, sensors, and valve solenoids.

Flow Check Delay

The specified time period prior to taking flow measurements (range from 2 to 6 minutes) to allow for water line stabilization.

Flow Max

Multiple controller system configuration comprised of one submaster and one or more satellites. This unique feature allows controllers to utilize a single point of connection to share devices (i.e. Flow Sensors, Master Valves, Pumps, etc.) and intelligently manage system operation.

Flow Sensor

A rotating paddle device placed in a main water line used to measure water flow. The device must be calibrated using K and Offset values to compensate for pipe size.

Inter Station Delay Time

The amount of time between when one station stops irrigating and the next scheduled station begins.

Irrigation Program

See Program.

ISC

Individual Station Control (ISC) is an alternative programming mode that treats an individual station like a program. The user enters water days, start times, and runtimes for each station programmed as an ISC.

K Value

A numeric value required for the proper setup/ calibration of flow sensors.

Learn

Feature that automatically establishes upper and lower limits for flow and current.

Limit Checking

The controller validates user defined upper and lower limits for flow, and current readings. Violations are reported in the warning/report buffer.

Main Flow

The maximum flow limit for a complete irrigation system.

Manual Control

Manual control provides maintenance personnel the ability to turn on/off individual stations and programs. The controller can also be placed in rain shutdown for either a programmable or indefinite amount of time.

Master Valve

A dedicated controller output which is activated by the controller each time a program start time occurs (typical operation). This output is typically connected to a Pump or another valve which acts as the master enable for all irrigation.

Moisture Sensor

A water sensing device placed in the root zone of a watering area which monitors the amount of water application.

Normally Closed Valve

Master Valves are normally closed and must be energized to deliver water flow.

Normally Open Valve

Master valve that is normally open and must be energized to turn off.

Non-participant satellite

A controller in a Flow Max system but specifically programmed not to share devices with the other Flow Max system controllers.

Offset Value

A numeric value required for the proper setup/calibration of flow sensors.

Omit by Date

Feature which allows the user to specify dates which irrigation will be disallowed (any programmed start times which occur on these dates will be skipped).

Over Current

Condition at any station that detects an excessive amount of electrical current.

Overlap Protection

Feature which insures that no two programs will run during the same time.

Participant satellite

A controller in a Flow Max system that shares devices with the other Flow Max system controllers.

Percent Run Time

Provides the ability to modify the run times of all stations in a given program. A station run time programmed at 10 minutes would run for 5 minutes if the percentage run time is set to 50%.

Program

A program provides a way of grouping stations with similar irrigation characteristics so that the start/stop of water can be controlled automatically. In order to establish a valid program the user must specify:

1. The station numbers associated with the program (stations).
2. The time(s) during the day when the program is executed (start times).
3. The days of the week when the program is to be executed (water days).
4. The amount of time each station operates (station run time).

Pump

A device that delivers water from a water resource, such as a well or lake, to the

irrigation system.

Rain Hold

A feature which stops all irrigation in the event of rain. Several options are associated with rain shutdown including:

1. Rain hold on/off (indefinite period)
2. Programmable rain shutdown (user specifies the amount of time which the controller is in rain hold)
3. Rain hold enable/disable on a per program basis.

Run Time

The amount of "on" time either in minutes/seconds or hours/minutes (setup option) for a station.

Satellite

A term used for any controller which is connected to a Central Control System or a submaster.

Satellite Address

Identifies each satellite within a multiple controller system. The address number is alternately displayed on the base screen with the program number.

Sensor

A device used to detect and measure flow, moisture, wind or ET (evapotranspiration).

Start Time

The time of day which a program (or ISC) starts its execution.

Submaster

A submaster is a term used for a DXi controller which is being operated in conjunction with an RMIS Central Control System. A submaster is a controller which has specialized communications capability. It can be set up for direct two-way communications with the Central Control PC either via radio, ethernet, wifi, or wire. Additionally, the submaster has additional responsibility for communications to any satellites which may be physically connected to it.

Unscheduled Flow

Defined as any water flow that is not scheduled or under the control of the controller.

Upper Limit

The maximum flow values or current allowed for a station or valve before a violation or alert occurs.

Report

An accounting of irrigation statistics and water usage.

Water Days

User defined (programmed) days which irrigation shall occur on.

Water Window

A user specified period of time where irrigation is allowed. The watering window is specified on a daily basis by establishing a daily start and end time.

Index

Symbols

14-day 38
31-day 38
% Adjust 17, 43

A

About 78
Alert # 58
Alert - Clearing an Alert 58
Alert - Flow Lower Limit 60
Alert - Flow Upper Limit 60
Alert - High Temp 60
Alert - Limit 58
Alert - Max Station Limit 61
Alert - MV High Current 60
Alert - P/MV 58
Alert - Recorded 58
Alert - Reset 60
Alerts 57
Alert - Start Block Max Stations 61
Alert - Start Block Program Running 61
Alert - Start Delay Overlap Protection
61
Alert - Station Communication 60
Alert - Stn 58
Alert Type 58
Alert - Water Limit 61

C

Cancel Rain Hold 40

Communications 28
Continuous Cycle 42, 76
Control Dial 8
Controller Events 49
Current 46
Current Checks 31
Current Monitoring 112
Cycle & Soak 47
Cycle Time 47

D

Date 12, 32
Devices 99, 120
Diagnostics - Communications 53
Diagnostics - General 50
Display Test 52

E

Erase 43

F

Faceplate 7
Firmware Update 32
Flow 22, 45, 78
Flow Charts 84
Flow Check Delay 24
FLOW MAX 33, 119
FLOWMAX Communications 53
FLOWMAX Sensors 54
Flow Options 23
Flow Sensors 22, 103

H

Help 6

I

Inter-Station Delay 41, 76
Interval 38
Irrigation Program 41, 76
ISD Delay 41

K

Keypad Test 53
K Values 105

L

Language 26
Last Confirmed On 77
Learn Current 26
Learn Flow 26
LEDs 9

M

Main Line Limit 24
Manual Operation 18, 67
Manual - Program 67
Manual - Sequence 67
Manual - Simultaneous 67
Manual - Station 67
Master Valves 41, 76
Monitoring 25
Monthly Limit 24
MV/P Inter-Station 41, 76
MV/P Start Delay 41, 76

N

Non-Participant 125

O

Offset and K Values 105
Omit by Date 42
OPT IN's 41
Output Test 51
Overlap Protection 42
Over-Water Limit 42

P

Participant 125
Percent Adjust 77
Program 37, 71, 74
Program Test 52
Program Valid 75
Pumps 41, 76

Q

Quick Stations 39

R

Rain Hold 65
Ran Today 77
Reports 49
Reset 43
Review 73
Run Times 15, 39

S

Schedule Type 14, 76
Sensor Status 52
Sequence 70
Setup 21
Setup Screen 11
Simultaneous 69
Soak Remain 77
Soak Time 47
Specifications 101
Start Duration 75
Start Time 13
Start Times 38, 75
Station 68, 77
Station Count 33
Station Run Times 77
Stations 45
Station Sequence 77
Station Type 77
Submaster 28, 120
Submaster Address 28
System 73

T

Time 12, 32
Troubleshooting 81

U

Unscheduled Limit 24

W

Water Days 14, 38, 76
Water Usage 50
Water Use per Start 75

FCC Notice - Electromagnetic Compatibility

This equipment generates and uses radio frequency energy and if not installed and used properly, that is, in strict accordance with the manufacturer's instructions, may cause interference to radio and television reception. It has been type tested and found to comply with the limits for a FCC Class A computing device in accordance with the specifications in Subpart J of Part 15 of FCC Rules, which are designed to provide reasonable protection against such interference in a residential installation. However, there is no guarantee that interference will not occur in a particular installation. If this equipment does cause interference to radio or television reception, which can be determined by turning the equipment off and on, the user is encouraged to try to correct the interference by one or more of the following measures:

- Reorient the receiving antenna.
- Relocate the irrigation controller with respect to the receiver.
- Move the irrigation controller away from the receiver.
- Plug the irrigation controller into a different outlet so the irrigation controller and receiver are on different branch circuits.

If necessary, the user should consult the dealer or an experienced radio/television technician for additional suggestions. The user may find the following booklet prepared by the Federal Communications Commission helpful:

“How to Identify and Resolve Radio-TV Interference Problems”. This booklet is available from the U.S. Government Printing Office, Washington, DC 20402. Stock No. 004-000-00345-4.

Toro LIMITED WARRANTY

Excluding software and products formerly produced under the Toro™ brand name, Toro® offers the following coverage to its trade customers:

As a business within the Irritrol® family of products, Toro offers a 5-year manufacturer's warranty on all purchased controllers.

For the first year, from the date of original sale to the trade customer, product may be exchanged "hassle-free" over-the-counter, should it have original manufacturing defects. For years two through five from the date of original sale to the trade customer, all parts which are found to have original manufacturing defects, shall be repaired or replaced (Toro's choice), provided the product is returned to the original place of purchase or sent to the Toro Controller repair facility at 5825 Jasmine St, Riverside CA 92504, postage paid.

All Toro parts & accessories have a 2-year warranty, unless otherwise noted.

Toro Laguna Software has a 90-day warranty. All computer hardware purchased from Toro in conjunction with its PC-related software is NOT covered by any Toro warranty. Computer hardware and the installed operating system(s) is specifically covered by the hardware manufacturer's warranty as provided by the hardware manufacturer.

This warranty does not apply to loss or damage to the product due to improper installation, abuse, alteration, mishandling, accident, or if the product has been serviced by other than Toro or its authorized service centers. This warranty is not a consumer warranty and does not extend to anyone other than those trade customers who purchase Toro products.

NOTE: Toro is not liable for (i) failure of products not manufactured by Toro even though such products may be sold or used in conjunction with Toro products; (ii) indirect, incidental or consequential damages, including but not limited to vegetation loss during periods of malfunction or resulting non-use; (iii) any loss or damage (e.g., property damage) resulting from an installer's negligence; or (iv) implied warranties of merchantability or fitness for a particular purpose. Some states do not allow the exclusion of incidental or consequential damages, so the above exclusion may not apply to you.

In no event shall Toro be liable or in any way responsible, for any damages or defects in the product which were caused by repairs or attempted repairs performed by anyone other than an authorized Toro / Toro Service dealer or center.

This warranty supersedes all previous warranties and shall be the sole and exclusive warranty granted by Toro and shall be the sole and exclusive remedy available to the trade customer. Correction of defects, in the manner and period of time described herein, shall constitute complete fulfillment of all liabilities and responsibilities of Toro to the trade customer with respect to the product, and shall constitute full satisfaction of all claims, whether based on contract, negligence, strict liability or otherwise.

NOTE: The user is cautioned that changes and modifications made to the equipment without the express written consent of the manufacturer will void this warranty.

Toro CUSTOMER SERVICE: 1-800-777-1477

California Proposition 65 Warning Information

What is this warning?

Sometimes you will see a product for sale that has a label with a warning along the lines of the following:



WARNING: Cancer and Reproductive Harm –
www.P65Warnings.ca.gov.

The warning is required by California labeling law Proposition 65 (or Prop 65 for short), which is meant to notify individuals in California of exposures to Prop 65-listed chemicals. Prop 65 does not ban the sale of any products containing these chemicals; it only requires warnings. Moreover, a Prop 65 warning does not mean a product is in violation of any product-safety standards or requirements. In fact, the California government has clarified that a Prop 65 warning “is not the same as a regulatory decision that a product is ‘safe’ or ‘unsafe’.”

See <https://oag.ca.gov/prop65/faqs-view-all>.

What is Prop 65?

Prop 65 is broad law that applies to any company operating in California, selling products in California, or manufacturing products that may be sold in or brought into California. It mandates that the Governor of California maintain and publish a list of chemicals that are known to cause cancer, birth defects and/or other reproductive harm. The list, which must be updated annually, includes a wide variety of chemicals that can be found in many everyday items. The purpose of Prop 65 is to ensure that people are informed about exposure to these chemicals.

Prop 65 also requires warnings to be placed on any product, product packaging, or literature accompanying a product that contains or may contain any of the hundreds of chemicals that the State of California considers harmful. Many of the chemicals listed under Prop 65 have been routinely used in everyday products for years without documented harm.

A Prop 65 warning generally means one of two things: (1) a business has evaluated the exposure and has concluded that it exceeds the “no significant risk level”; or (2) a business has chosen to provide a warning simply based on its knowledge or understanding about the presence of a listed chemical without attempting to evaluate the exposure.

Does this law apply everywhere?

Prop 65 warnings are only required under California law. Prop 65 warnings are seen throughout California in a wide range of settings -- in restaurants, grocery stores, hotels, schools, hospitals, and on a wide variety of products. In addition, some Internet and mail order retailers have chosen to provide Prop 65 warnings on their websites or in catalogs for all their products and for all consumers. Prop 65 standards are among the most stringent standards in place anywhere and are often far more stringent than federal standards.

How do the California warnings compare to federal limits?

It should be noted that California product label warning requirements are not usually the same as federal safety requirements. This causes a variance between warnings on products sold in California and what is required elsewhere in the U.S.A and other parts of the world. This can explain why sometimes you may see a Prop 65 warning on a product sold in California but no warning on the same product sold elsewhere. The products are not different but Prop 65 warnings are required for sales in California.

Additionally, there are various substances that require a Prop 65 warning at levels that are far more stringent than federal action limits. One example is lead. The Prop 65 standard for warnings for lead is 0.5 micrograms per day, which is far more stringent than federal and international standards for lead.

Why don't all similar products carry the warning?

There could be a variety of reasons. If a company has been involved in a Prop 65 lawsuit, and if that company reaches a settlement, that settlement may require Prop 65 warnings for products.

Other companies that are not involved in the settlement, although they may nonetheless sell similar products, may not provide a warning on their product. Because of inconsistent Prop 65 enforcement, this sometimes explains why you will see certain products in the market with warnings, and virtually identical products without warnings. Other companies may elect not to provide warnings because, in their assessment, they conclude that they are not required to do so under Prop 65 standards. A lack of warnings for a product does not necessarily mean that the product is free of the same substances at similar levels.

Why does Toro include this warning?

Toro believes the best practice is to provide consumers with as much information as possible so they can make informed decisions about the products they purchase and use.

Toro has chosen to provide warnings in certain cases based on its knowledge about the presence of one or more listed chemicals without attempting to evaluate the level of exposure, as not all of the listed chemicals provide exposure limit requirements. With [Brand Name]'s products, the exposure may be negligible or well within the "no significant risk" range.

However, out of an abundance of caution, Toro has elected to provide the Prop 65 warnings. Moreover, if Toro does not provide these warnings, it can be sued by the State of California or by private parties who seek to enforce Prop 65 and subject to substantial penalties.

Notes

Patent: www.ttcopats.com

© 2022 The Toro Company, Inc.
www.toro.com

Part Number 373-0920 Rev. G



**5825 Jasmine St.
Riverside, CA 92504-1183
Toro support: 800.777.1477
irrigationsupport@toro.com
www.toro.com/dxi**



We reserve the right to improve our products and make changes in the specifications and designs without notice and without incurring obligation. Products depicted in this brochure are for demonstration purposes only. Actual products offered for sale may vary in design and features.

©2021 The Toro Company, All Rights Reserved