



# GOLF IRRIGATION 2025 SPECIFICATION CATALOG



## *Always solving. Always evolving.*

At Toro, innovation isn't just about big ideas. It's about listening and helping you solve your most important challenges. Behind every patent is a drive to keep you ahead of the game with future-ready products that make your job easier. From advanced irrigation systems to all-electric equipment, no other brand has a more complete lineup – or a stronger network to support you.





# Contents

## CONTROL SYSTEMS & FIELD CONTROLLERS

IntelliDash®	3-4
Lynx® Central Control System	5-6
Field Controller Comparison Chart	7
Lynx Smart Module 2-Wire Control System	9-10
Lynx Smart Satellite	11-12
OSMAC® G4	13-14

## CONTROL SYSTEM UPGRADES

Sensor Input Kits for Satellite Controllers	15
Sensors	16
Field Interface Unit (FIU) & LynxSmart Field Interface (LSFI)	17
Network LTC™ Plus to Network VP™	18
Network LTC Plus to LTC Pro	19

## SPRINKLERS & SUBSURFACE DRIP

INFINITY® Series Rotors Comparison Charts	19
INFINITY Series Rotors	21-40
INFINITY Series Accessory Kits	41-42
Sprinkler Comparison Charts	43-44
FLEX800™ Series Rotors	45-64
FLEX800 B Series Rotors	65-66
Intermediate Nozzle Performance Charts	67-68
Sprinkler Conversions Assemblies	69
FLEX800 R Series Conversion Upgrades	70-71
T7 Series Rotors	73-74
690 Series Golf Sprinklers	75-76
590 Series Golf Sprays	77
Precision™ Series Spray Nozzles	78-82
Subsurface Irrigation	83-84
Swing Joints	85-86
Golf Sprinkler Tools	87-88

## VALVES

Valve Comparison Chart	89
220G Brass Series Valves	91-92
P220G & P220GS Series Valves	93-94
Valve Boxes	95-96
Dry Boxes	97-98
470 Quick Coupler Valves	99-100

## RESOURCES

Wire Sizing and Technical Data	101
Warranty	102
Support & Resources	103
Toro NSN® (National Support Network)	104
Golf Irrigation Partners	105



# IntelliDash®

One Streamlined Dashboard

## Specifications

**The Intelligence you need. All in one place.**

**Bring all your key golf course management information into one streamlined dashboard.**

- ✓ **Course data at-a-glance**  
View real-time agronomic conditions, labor, asset location and equipment health.
- ✓ **Information organized from many different sources**  
Displays information from Lynx® Central Control, myTurf® Pro, ezLocator®, taskTracker™, Playbooks™, Turf Guard® sensors and more!
- ✓ **Adaptable**  
Adapts as equipment & irrigation system capabilities evolve, continually giving you the latest tools and information with new widgets being added frequently.
- ✓ **Streamlined**  
Dive deeper into any info with a single touch.
- ✓ **Customizable**  
Personalize each connected device to show what matters most to you or any team members. Tailor widgets by turning them on or off and arranging essential widgets at the top for easy access.



*ezLocator, taskTracker, and Playbooks are trademarks of their respective companies in the U.S. and other countries.*



Scan the code or visit <https://toro.com/intelldash> to sign up





# IntelliDash®

*One Streamlined Dashboard*

## Alerts & Notifications

- Receive notifications in IntelliDash
- Setup Email and SMS alerts for one or a group

- ✓ **Simplify course operations**
- ✓ **Gain efficiencies**
- ✓ **Better allocate resources**
- ✓ **Keep an eye on what's important anywhere, anytime**

## View current & forecasted weather conditions

- Local and on-site weather conditions
- Weather radar mapping
- 7-day ET forecasting
- Frost warning

***IntelliDash is included as part of myTurf® Pro and NSN® Subscription at no charge.***



## IntelliDash® ALLIANCE

- View most important data you rely on regularly from Toro® and non Toro tools
- Easily link to the full software platform
- Subscribe to the 3rd party tools you want to use

**IntelliDash unites industry leaders to transform golf course management.** By centralizing critical data into one accessible hub, IntelliDash enables professionals to monitor metrics effortlessly, boosting system efficiency for peak performance and operational excellence.



## Specifying Information — IntelliDash

### Description

Please contact your local distributor if you are interested in IntelliDash



# Lynx<sup>®</sup> Central Control

Irrigation Control From Anywhere, Anytime.

## Specifications

### Lynx<sup>®</sup> Levels Comparison

System Capacity	Lynx CE	Lynx PE	Lynx SE
Satellites	500	500	500
Satellite Stations	32,000	1344	512
LSM Stations	6400	1000	500
Weather Stations	10	10	10
Pump Stations	10	3	2
Courses	3	2	1
Holes	48	48	48
Hydraulic Branches	1024	300	100
Hardware Supported			
Lynx <sup>®</sup> SMART HUB	Yes	Yes	Yes
OSMAC <sup>®</sup> G4	Yes	Yes	Yes
LSM	Yes	Yes	Yes
Lynx <sup>®</sup> Smart Satellite	Yes	Yes	Yes
Programming			
Current Sensing	Yes	No	No
Station Adjust Upload	Yes	No	No
Site Code Categories	7	3	No
Precip. Mgmt. Groups (PMG)	Yes	Yes	No
Max. Stations/Hole Control	Yes	Yes	No
Instant Program Creation	Yes	Yes	Yes
Program Priority	Yes	Yes	No
Pump Profiling	Yes	Yes	No
Pump Integration	Yes	Yes	Optional
Weather Station Alarms	Yes	Yes	Optional
ET Auto Calc. RT Method	Yes	Yes	Optional

### Additional Features

- ✓ **Runtimes:**
  - Runtimes to the second for more precise irrigation and water savings
  - Plan your irrigation based on runtimes or watering amounts
  - Know exactly what watered overnight and manually throughout the day
- ✓ **Lynx Cloud:**
  - Turn stations on/off immediately or apply a delay
  - View Course Report and see what ran automatically and manually down to the second
  - Make percent adjustments right from your phone
  - Use Find Me Button to locate stations near you directly on the map
  - Place stations on hold indefinitely or for some number of days
- ✓ **Communication:**
  - Diagnostics alert you to potential issues before irrigation interruptions occur
  - Two-way communication with Toro<sup>®</sup> equipment
  - Weather station integration and Handheld Remote Interface support are included as standard features
- ✓ **Ease of Access:**
  - **IntelliDash<sup>®</sup>** – Your entire operation in one dashboard
  - **Lynx Map** – GPS location for quick manual operation anywhere on the course
  - **Lynx Handheld** – All in one command set, command log, last dialed
  - **Lynx Bar Code** – Add, replace or field test units



Available for LYNX, the NSN<sup>®</sup> Connect app allows remote control irrigation & access to irrigation support to get the help you need anytime, anywhere.

Scan the QR code to learn more or visit [toro.com/nsn](http://toro.com/nsn)





# Lynx<sup>®</sup> Central Control

*Irrigation Control From Anywhere, Anytime.*

## Lynx<sup>®</sup> Central Control System

Was developed to specifically help superintendents address the unique challenges and changing priorities they face every day.

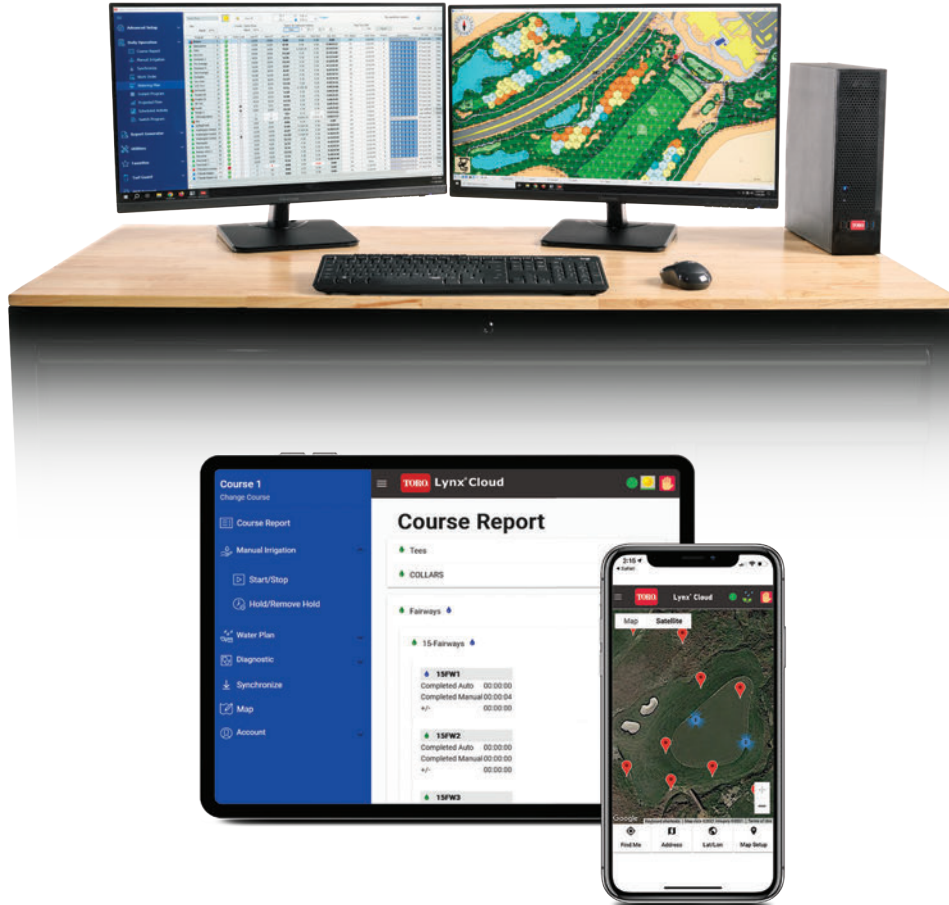

### Specifying Information — Lynx Central Control

LX-0X-X-XX				
Model	Computer Hardware	Service	Levels	Field Hardware
<b>LX</b>	<b>0X</b>	<b>X</b>	<b>X</b>	<b>X</b>
LX-LYNX Central Control	5—Lynx Smart Tower	1—1-year NSN <sup>*</sup> 5—5-years NSN	0—CE 1—SE 2—PE	1—For OSMAC <sup>*</sup> 7—For Lynx Smart Satellite 8—For 2-wire
<b>Example:</b> When ordering a LYNX Central with Lynx Smart Tower, with one year of NSN and CE Level with Lynx Smart Satellite field hardware, you would order: <b>LX-05-1-07</b>				

### Specifying Information — Lynx CE Central Upgrade for SitePro<sup>®</sup>

Model	Description
LX-NSN-SMARTOW LX-NONNSN-SMARTOW LX-SW	Lynx Upgrade - NSN - Lynx Smart Tower Lynx Upgrade NSN Lynx Smart Tower and 1-year NSN Support Software, Lynx, Client/Server





# Lynx<sup>®</sup> Field Controllers & Control Systems



Feature/Capability	Lynx Smart Module	Lynx Smart Satellite
<b>Catalog Pages</b>	<b>11-12</b>	<b>13-14</b>
Maximum Stations Per Controller	1000	64
Maximum Simultaneously Operating Stations Per Controller	200	32
Stand-Alone Programs	20	64
Wireline Field Communication	Yes	Yes
Wireless Field Communication	Yes	Yes
Upload Field Changes	No	Yes
Field Controller Alerts	Yes	Yes
Downloaded Programs	Yes	Yes
Station Based Flow Management	Yes	Yes
Station Runtimes In Seconds	Yes	Yes





# Lynx<sup>®</sup> Smart Module 2-Wire Control System

## Specifications

### Operational

#### Lynx Central:

- Mapping capabilities
- Remote hand-held operation
- Weather station integration
- Pump station integration

#### Enhanced diagnostics:

- Communication
- Electrical shorts/opens
- Solenoid check

### Installation

- **Maximum number of wire paths:** 4 per gateway
- **Maximum number of Lynx Smart Hubs:** 20 per system
- **Maximum number of modules per wire path:** 250
- **Maximum stations per Lynx Smart Hub:** 1000
- **Maximum stations per system:** 10,000
- **Simultaneous stations per output board:** 100
- **Maximum distance from central to module (using 14 gauge wire):** 2.8 miles
- **Maximum distance from module to sprinkler (using 14 gauge wire):** 400 ft.
- **Solenoids per output:** 2 DCLS-P
- **Stations per module:** 1

### Electrical

- **Input power:** 88-264 V ac, 50/60 Hz
- **Output Power:**
  - **Output voltage:** 40 V ac max
  - **Output power:** 75 VA max
  - Class 2, SELV
- ISP 2-wire modules are rated at 20 KV surge protection
- **2-Wire modules wiring:** 14 awg

### Integrated Sprinkler

Toro INFINITY<sup>®</sup> and FLEX800<sup>™</sup> Series sprinkler models have an integrated 2-wire module option.

#### Precision:

- Run-time in seconds
- Schedule by time or amount (in.)

#### Durability:

- Surge protection up to 20 KV, 10 KA
- Waterproof

#### Upgradeable:

- Firmware over the air (FOTA)



### Specifying Information — 2-Wire Modules

LSM-1	
Type	Configuration
<b>LSM</b>	<b>X</b>
Lynx Smart Module	1—1-station
<b>Example:</b> A 1-station Lynx Smart Module would be specified as: <b>LSM-1</b>	

*\*Refer to sprinkler pages for specifying information on Sprinkler 2-wire Modules*





# Lynx<sup>®</sup> Smart Module 2-Wire Control System

## Lynx Smart Hub

Lynx Smart Hub is a new type of field controller that adds security, programmability and sensing to the benefits and simplicity of a two-wire system.



- ✓ The system can be segmented into manageable areas for simplified maintenance
- ✓ Provides for in-field manual operation or troubleshooting
- ✓ Stores and runs a fully flow-managed irrigation schedule in the event the central computer is offline
- ✓ Creates a convenient point of connection for soil, flow and status sensors

## Lynx Smart Hub



Lynx Central Control

+



FIU-2011DR

+



DEC-RS-1000-M

or



DEC-RSP-1000-DR

## Specifying Information — Gateway or Lynx Smart Hub

<b>DEC-XXX-XXXX-XX</b>				
Type	Configuration	Cabinet	Station Count	Communication Type
DEC	XXX	X	XXXX	XX
DEC	RS—Lynx Smart Hub	WM Metal P—Green Plastic Pedestal B—Brown Plastic Pedestal T—Tan Plastic Pedestal	1000—1000 Stations, Lynx Smart Hub*	M—Wireline DR—Radio

Example: A1000 station Lynx Smart Hub with green plastic pedestal and radio communication would be specified as: **DEC-RSP-1000-DR**

*Note: A blank after RS indicates the wall mount cabinet. P, B, and T indicate green, brown, and tan plastic pedestals.*



# Lynx<sup>®</sup> Smart Satellite

## Specifications

### Operational

- **Functions as a stand-alone controller or under the management of a central computer operating Lynx or SitePro<sup>®</sup> Central Control System**
  - Supports wireline or radio communications
  - Supports hybrid communication (wireline and radio)
- 64 irrigation programs
- Basic, Advanced and Grow-In programs
- Station Autocycle
- Percent Adjustment from 1% to 900%
- Each output can be defined as an irrigation station or general application switch
- Non-volatile memory retains program information and satellite settings during power-off conditions; battery backup retains the date and time
- 16-64 stations in 16 station increments; individual station control and the ability to run up to 32 stations simultaneously
- Backward compatible with Toro<sup>®</sup> Network VP<sup>®</sup> and Network 8000 satellite systems

### Electrical

- **UL Listed**
- **Input Power**
  - 108 V ac to 132 V ac, 60 Hz**
    - 0.20 amps (no load) 115 V ac
    - 1.2 amps (max. load) 115 V ac
  - 216 V ac to 264 V ac, 50 Hz**
    - 0.10 amps (no load) 230 V ac
    - 0.60 amps (max. load) 230 V ac
- **Output Power**
  - 24 V ac: 3.0 amps (max. total load)

### Temperature/Humidity

- **Operating Temperature:** 15°F to 140°F
- **Storage Temperature:** -22°F to 149°F
- **Humidity:** 0% to 95% RH (noncondensing)

### Options

- Surge Protection
- Sensor Input Kit

### Dimensions

- **Plastic Cabinet:**  
17"W x 40"H x 16"D

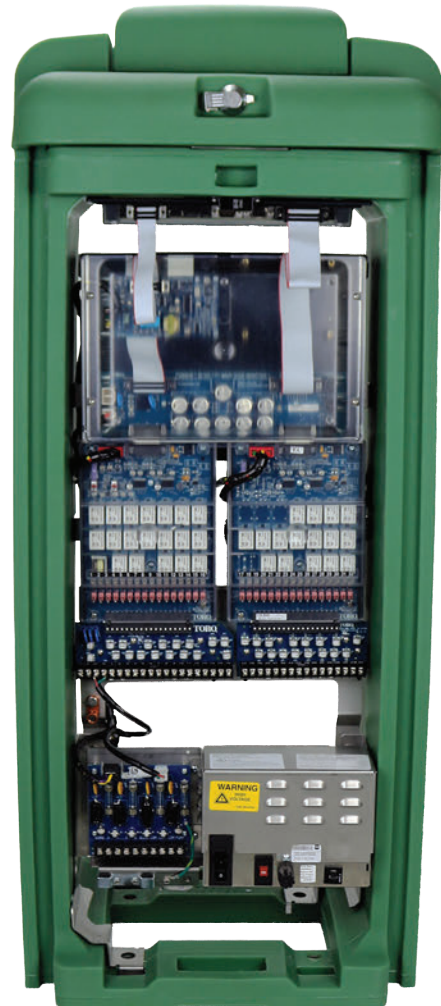



# Lynx<sup>®</sup> Smart Satellite

**Designed For Performance**

- ✓ High-contrast backlit display
- ✓ Intuitive navigation
- ✓ Processor & memory for future enhancements



**Three Pedestal Colors Available**

Custom pedestal color options help satellites blend into their natural surroundings.

<<< (Green, Tree Bark, and Desert Sand)

**Specifying Information — Lynx Smart Satellite**

300-0XXY6ZSA					
Description	Configuration	Cabinet	Output	Comm.	Options
<b>300</b>	<b>XX</b>	<b>Y</b>	<b>6</b>	<b>Z</b>	<b>S</b>
300—Lynx Smart Satellite	16—16 Stations 32—32 Stations 48—48 Stations 64—64 Stations	P—Plastic, Green T—Desert Sand B—Tree Bark	6—24 VAC Electric	A—Stand-alone M—2-Way Wire Modem R—UHF Radio H—Radio & Wire Modem	3—Large-capacity Terminal Block & Switches 4—Large-capacity Terminal Block w/Add'l Surge & Switches

**Example:** When ordering a 48-station, radio-equipped, Lynx Smart Satellite with large-capacity terminal block, additional surge and switches, specify: **300-048P6R4A**

Sensor Input Kit for Lynx Smart Satellite: **SMRT-SEN-BRD-KIT**





# OSMAC® G4 Satellite

## Specifications

### Operational

Functions under the management of a central computer operating Lynx®, or SitePro®, Central Control System, or as a stand-alone controller.

Stations: 16 to 64 in 16 station increments

- Up to 32 stations may operate simultaneously
- Station run times received from Lynx Central are executed to the second, from 1 second to 8 hours and 59 minutes
- Station run times programmed in Local mode are executed to the minute, from 1 minute to 59 minutes
- Any station can be configured as a switch. Switch operation will ignore rain hold and does not activate the pump/master valve circuit

### Local Mode Operations

- 12 independent local programs
- 14 day calendar or 1 to 30 day interval scheduling
- Up to 24 start times per program
- Simultaneous station operation defined independently per program
- Program percent adjust from 10% to 250%
- Non-volatile memory saves program data for up to 10 years without power

### Manual Operations

- Multi-Manual station start up to 32 stations
- Program start
- Program syringe

### Electrical

- **Input power:** 120/240 V ac, 50/60 Hz

### OSMAC G4:

- 0.20 amps, 110-120 V ac, 60 Hz (no load)
- 0.96 amps, 110-120 V ac, 60 Hz (max load)
- 0.10 amps, 220-240 V ac, 50/60 Hz (no load)
- 0.47 amps, 220-240 V ac, 50/60 Hz (max load)

### Options

- Surge protection

### Dimensions

- **Plastic Cabinet:**  
17"W x 40"H x 16"D





# OSMAC® G4 Satellite

**Upgrade kits** for E-OSMAC satellites adds new functionality, including program storage for stand-alone function & a user interface for performing manual irrigation or diagnostic activity.



## OSMAC G3 Upgrade Kit for E-OSMAC

✓ **Upgrade E-OSMAC satellites with the OSMAC G3 Upgrade Kit**

- Add a point of operation at the satellite controller for performing manual irrigation or referencing diagnostic information, including communications details through Page History.
- Add backup program storage for stand-alone operations when in Local mode.
- Upgrade receiver hardware to a high-performance receiver radio for improved reliability and for signal strength indication.

### Specifying Information — OSMAC G3 Upgrade Kit

<b>118-2987</b>
<i>Kit Contains</i>
OSMAC G3 Timing Module, Interface Cable and Hardware

### Specifying Information — OSMAC G4 Satellites

<b>G4-XXX6RX</b>					
Description	Configuration	Cabinet	Output	Communication	Options
<b>G4</b>	<b>XX</b>	<b>X</b>	<b>6</b>	<b>R</b>	<b>X</b>
G4 – OSMAC G4 Satellite	16 – 16 Stations 32 – 32 Stations 48 – 48 Stations 64 – 64 Stations	P – Plastic Green B – Plastic Tree Bark T – Plastic Desert Sand	6A – 24VAC	R – Narrowband Radio	3 – Large Terminal Blocks, Switches 4 – Large Terminal Blocks, Switches, Premium Surge

**Example:** When specifying a 48-station, satellite in a green plastic cabinet with large terminal block, switches and premium surge you would specify: **G4-48P6R4**



# Control System Upgrades & Sensors

## Specifications

### Sensor Input Kits for Satellite Controllers – Network VP® & Lynx® Smart Satellite

The Sensor Input Kits for Lynx Smart Satellite and Network VP deliver important field data to the superintendent's office. Relevant data is the foundation of informed decision making, whether the decision is made by a human or a computer. A satellite controller equipped with either of the two Sensor Input Kits can receive data from up to seven sensors. The satellite collects, stores, and delivers the data to Lynx, where it can be accessed by the superintendent on the Sensor Dashboard. Lynx also can respond automatically to changes to the irrigation system and changes in weather conditions. A Sensor Input Kit can help save the valuable resources of time and water, and help keep course conditions at their best.

#### A. Sensor Input Kit, B. Sensor Board, & C. Terminal Board for for Network VP

A.



VP-SEN-BUNDLE

118-5487SK VP Timing Module – Sensor Compatible

B.



VP-SEN-BRD-KIT

C.



#### Sensor Input Kit for Lynx Smart Satellite



SMRT-SEN-BRD-KIT

### Lynx® Sensor Alarms & Responses:

Automatically safeguard your course, eliminate water waste, and ensure efficient irrigation. Sensor alarms and responses can be easily configured in Lynx with numerous options for responses to alarm conditions.

**Alarm & Response Examples:** Pressure Sensor: Set alarm conditions and response for high and/or low pressure

- ✓ A text notification or email can be sent if pressure falls below a specified value

**Rain Gauge:** Prevent, suspend or adjust irrigation in the event of a measurable rain

- ✓ Lynx will account for measured rain hourly or daily and automatically apply a Rain Hold or adjust scheduled irrigation based on rain fall received

**Temperature Gauge:** Set alarm conditions and response for high and/or low air temperature

- ✓ Activate greens fans through a satellite switch output when air temperature exceeds the alarm value for a set duration
- ✓ Suspend irrigation when air temperature is near freezing

**Switch Status:** Set alarm conditions and response for changes in switch state

- ✓ Control pond or tank water level using level switches to trigger a pump or valve to transfer water, maintaining water level within a set range

**Flow Meter:** Set alarm conditions and response for high and/or low flow rate

- ✓ A satellite switch can be closed if a flow is out of tolerance, signaling the pump station to shut down





# Control System Upgrades & Sensors

## Sensors

**Sensor Input Kits can accept up to seven sensors; they are compatible with the following sensors:**

- (1) Pressure sensor
- (1) Temperature sensor
- (5) Flow meter, rain gauge, or switch status

**Satellites with Sensor Input Kits accommodate up to 56 station outputs:**

- The Sensor Input Kit for Network VP® includes a sensor input board that replaces an eight station output board
- The Sensor Input Kit for Lynx® Smart Satellite is a module with eight station outputs and seven sensor inputs. Replaces a sixteen station output board.
- Lynx version 5.0 or later is required for Sensor Input Kits
- The Sensor Input Kit for Network VP includes a new Timing Module with faster processor, larger display, and expanded memory



### Pressure Sensor

Approved Model: PRESS200-SEN-KIT  
Pressure Sensor Kit: 0 – 200 PSI

### Sensor Input Kit for Network VP

**Model:** VP-SEN-BUNDLE

- 118-5487SK: VP Timing Module, Sensor compatible

### Sensor Input Kit for Lynx Smart Satellite

**Model:** VP-SEN-BRD-KIT: Sensor Board and Level 4 Terminal Board

### Sensor Input Kit for Lynx Smart Satellite

**Model:** SMRT-SEN-BRD-KIT

### Pressure Sensor Kit

**Model:** PRESS200-SEN-KIT

- 0 – 200 PSI
- ¼" – 18 NPT male thread



### Temperature Sensor

Approved Model: TEMP-SEN-KIT  
Temperature Sensor Kit

## Recommended Models:



### Flow Meter

Recommended Models:  
Data Industrial® Series 200  
or Bermad® 900 M Series



### Rain Gauge – Tipping Bucket

Recommended Model:  
Texas Electronics TR 525I



### Radiation Shield for Temperature Sensor

Recommended Model:  
Davis® #7714



# Field Interface Unit (FIU)

**The Communication Bridge** – Every golf control system needs an interface between the central control and the field hardware. The Field Interface Unit (FIU) features LED indicators to show communication activity on all channels. The FIU offers the flexibility to allow customers to design their irrigation system to meet their needs. Compatible with both wire-line and digital radio systems, the FIU provides the communication solutions for any terrain and distance.

- ✓ Provides wired and wireless system interface solutions
- ✓ Compatible with Digital Radio Upgrade kits
- ✓ LED Indicators show connection activity and status
- ✓ True 2-way communication
- ✓ Multi-port field interface allows one radio to be shared among many satellites
- ✓ Compatible with all Lynx Smart Satellite, Lynx Smart Hub & legacy Toro systems



## Specifying Information — Field Interface Unit (FIU)

Model	Description
FIU-2011	Field Interface Unit with 1 Wire Line & 1 Radio Line, Radio Not Included
FIU-2011DR	Field Interface Unit with 1 Wire Line & 1 Digital Radio Line, Radio Included
FIU-2021	Field Interface Unit with 2 Wire Lines & 1 Radio Line, Radio Not Included
FIU-2021DR	Field Interface Unit with 2 Wire Lines & 1 Digital Radio Line, Radio Included

*Note: FCC license required.*



# Lynx<sup>®</sup> Smart Field Interface (LSFI)

**The Lynx Smart Field Interface (LSFI)** is easily deployable wherever a LAN connection exists. Its color touch screen simplifies setup and usage. This innovative interface merges the capabilities of the OSMAC<sup>®</sup> base station and hand-held remote interface (HHRI) into a single unit. Available in dual radio for combined Base Station and HHRI tasks or a programmable single radio, the LSFI suits both legacy Toro systems and new designs.

- ✓ A large color touch screen streamlines navigation through an intuitive graphic interface
- ✓ Enables remote system control for on-the-go management
- ✓ Provides handheld control and central-to-satellite communication
- ✓ Designed to operate continuously, 24/7 to keep your system reliable
- ✓ Interfaces with Lynx Central Control software without the burden of recurring network costs
- ✓ Tailored to fit your application with programmable selections for:
  - OSMAC Base Station and hand-held remote interface modes
  - Independent transmit/receive UHF frequencies

**Note:** *FCC license is necessary.* The LSFI functions as a replacement for all applications of RIU and older OSMAC base stations

## Specifying Information — Lynx Smart Field Interface (LSFI)

Model	Description	Replaces
LSFI-K	Lynx Smart Field Interface – Single Radio	RIU-01
LSFI-KK	Lynx Smart Field Interface – Dual Radio	RIU-02

*Note: FCC license required.*





# Control System Upgrades

## Network LTC™ Plus to Network VP®

Available as an upgrade kit for existing LTC Plus satellites. Upgrade kit includes Network VP faceplate, Network LTC Plus to Network VP power distribution board, cable and hardware.

- ✓ Station based flow management shortens watering window
- ✓ Intuitive user interface simplifies manual irrigation
- ✓ Station runtimes executed to the second helps save water
- ✓ Upgrade to Lynx® for enhanced central capabilities (requires all satellites to be upgraded)



### Specifying Information — Network LTC Plus Upgrade Kit

<b>118-0038</b>
<b>Kit Contains</b>
Network VP Faceplate, Network LTC Plus To Network VP Power Distribution Board, Cable and Hardware

## Network LTC Plus to LTC Pro

Available as complete satellites or upgrade kit for existing LTC Plus satellites. Upgrade kit includes LTC Pro faceplate, power distribution board, cable & hardware.

- ✓ Intuitive user interface simplifies faceplate functions
- ✓ Enhanced manual operations
  - Runtimes to the second
  - Stackable multi-manuals
  - Start/Pause/Stop
- ✓ Backwards compatible with SitePro®
- ✓ Can upgrade one satellite at a time (*full system must be upgraded prior to a Lynx upgrade*)



### Specifying Information — LTC Pro Satellites

<b>LTCRXXX6XX</b>					
Description	Configuration	Cabinet	Output	Comm.	Options
<b>LTCR</b>	<b>XX</b>	<b>X</b>	<b>6</b>	<b>X</b>	<b>X</b>
LTCR - LTC Pro	16 - 16 Stations 40 - 40 Stations 64 - 64 Stations	P - Plastic Green	6 - 24VAC	M - Wire R - Radio	4 - Large Terminal Block, Switches, Premium Surge
<b>Example:</b> When specifying a 40-station, wire communication satellite, you would specify: <b>LTCR40P6M4</b>					

### LTC Pro Upgrade Kit

<b>118-4838</b>
<b>Kit Contains</b>
LTC Pro Faceplate, Power Distribution Board, Cable and Hardware

**TORO.**

# INFINITY® Series Golf Sprinklers

*Water Precisely Where You Want It*



Model	INF35-6 / INF55-6	INF35 / INF55	INF34 / INF54
<b>Catalog Pages</b>	<b>23-24</b>	<b>31-36</b>	<b>37-42</b>
Radius	42'-100'	43'-92'	52'-99'
Short Radius (mainless)	25'-51'	25'-50'	
Radius Reduction Screw		X	X
Back Nozzle Capable	X	X	
Inlet Size	1" & 1½" ACME	1" & 1½" ACME	1" & 1½" ACME
Below Grade Capable	Stealth-T	Stealth-D	Stealth-D
Grade Height Adjustable	Razor™	Razor	Razor
Turf	X	X	X
High Wind	X	X	X
LSM 2-wire Systems	X	X	X
Normally Open Hydraulic System			
Spike Guard™ Solenoid	X	X	X
Full Circle	X	X	X
Part-circle Adjustable	X	X	
Part/Full Circle In One	40°-330° & 360°	40°-330° & 360°	
Ratcheting Riser	X	X	
Check Valve			
Effluent Water Option	X	X	X
Trajectory Adjustment	7°-30°	25° & 15°	25° & 15°
Nozzle Base Clutching	X	X	
SMART ACCESS® Compartment	X	X	X
SMART ACCESS Cover	X	X	X
Removable Marker	X	X	X
Pilot Valve Serviceable Under Pressure	X	X	X
Warranty	3 Years/ 5 Years*	3 Years/ 5 Years*	3 Years/ 5 Years*

\*When purchased and installed with Toro® Swing Joints.  
X - Complete sprinkler requires the purchase and assembly of riserless bodies and conversions.  
# NPT and BSP models available as riserless bodies only.







# INFINITY<sup>®</sup> 35-6/55-6 Series Golf Sprinklers

## Specifications

### Operational

- **Inlet:**
  - INF35-6: 1" ACME
  - INF55-6: 1½" ACME
- **Radius:**
  - INF35-6: 42' – 92'
  - INF55-6: 52' – 100'
- **Flow Rate:**
  - INF35-6: 7.1 – 45.3 gpm
  - INF55-6: 13.9 – 61.1 gpm
- **Precipitation Rates:**
  - INF35-6: Minimum - .37"/hr; Maximum - .53"/hr
  - INF55-6: Minimum - .43"/hr; Maximum - .60"/hr
- **Pilot Valve:** Selectable at 50, 65, 80 and 100 psi
- **Recommended Operating Pressure Range:** 65-100 psi (maximum -150 psi and minimum - 40 psi)
- **Activation types – Electric Valve-in-Head:**
  - **Standard Solenoid:**
    - 24 VAC, 50/60 Hz
    - Inrush: 0.30 A
    - Holding 0.20 A
  - **Spike Guard™ Solenoid:**
    - 24 VAC, 50/60 Hz
    - Inrush: 0.12 A
    - Holding 0.10 A
  - **Nickel-Plated Spike Guard Solenoid:**
    - 24 VAC, 50/60 Hz
    - Inrush: 0.12 A
    - Holding 0.10 A
  - **DC Latching Solenoid (DCLS):**
    - Momentary low voltage pulse
  - **Integrated Lynx® Smart Module with DCLS:**
    - Momentary low voltage pulse
- **Trajectory:** 24 positions from 7° - 30° in 1° increments

### Additional Features

- INF35-6 has eight nozzle variations (30, 31, 32, 33, 34, 35, 36 and 37)
- INF55-6 has nine nozzle variations (51, 52, 53, 54, 55, 56, 57, 58 and 59)
- Four in-line nozzles, rotating stream pattern
- One back nozzle position
- Stator variations: INF35-6 – 3 and INF55-6 – 3
- Ratcheting riser
- Nozzle base clutching

### Warranty

- Three years
- Five years when installed with Toro® Swing Joints

### Dimensions

- **SMART ACCESS® Cover and Compartment Diameter:**
  - INF35-6: 7<sup>5</sup>/<sub>8</sub>"
  - INF55-6: 7<sup>5</sup>/<sub>8</sub>"
- **Body height:**
  - INF35-6: 10"
  - INF55-6: 11<sup>3</sup>/<sub>8</sub>"
- **Weight:**
  - INF35-6: 4.31 lbs.
  - INF55-6: 5.13 lbs.
- **Weight – Integrated with Lynx Smart Module:**
  - INF35-6: 5.00 lbs.
  - INF55-6: 5.82 lbs.
- **Pop-up height to nozzle:** 3¼"



# INFINITY® 35-6/55-6 Series Golf Sprinklers

## Trajectory – 24 Positions

From 7° - 30° in 1° increments put water where you want it. Adjust from the top of the sprinkler in seconds, wet or dry. *This flexibility lets you tackle every obstacle on the course; wind, trees, bunkers, mounds and more.*



### INF35-6 Conversion Upgrades

MODELS	DESCRIPTION
• INF35-6-3134	INF35-6 w/31-34 Nozzles (33 Nozzle Installed)
• INF35-6-3537	INF35-6 w/35-37 Nozzles (35 Nozzle Installed)
• INF35-6-3134E	INF35-6 w/31-34 Nozzles (33 Nozzle Installed), Effluent
• INF35-6-3537E	INF35-6 w/35-37 Nozzles (35 Nozzle Installed), Effluent



### INF55-6 Conversion Upgrades

MODELS	DESCRIPTION
• INF55-6-5154	INF55-6 w/51-54 Nozzles (53 Nozzle Installed)
• INF55-6-5558	INF55-6 w/55-58 Nozzles (55 Nozzle Installed)
• INF55-6-59	INF55-6 w/59 Nozzle Installed
• INF55-6-5154E	INF55-6 w/51-54 Nozzles (53 Nozzle Installed), Effluent
• INF55-6-5558E	INF55-6 w/55-58 Nozzles (55 Nozzle Installed), Effluent
• INF55-6-59E	INF55-6 w/59 Nozzle Installed Effluent



### Smart Access®

Provides top accessibility to all critical components.

- ✓ No digging or unsightly turf repair scars
- ✓ No buried wire splices or ground faults
- ✓ Pilot valve removable with water "ON"
- ✓ Lower long term cost of ownership
- ✓ Customizable marker
- ✓ Replaceable cover if damaged
- ✓ Increased labor efficiency

## Specifying Information — INFINITY 35-6 & INFINITY 55-6

INFX5-XXX-X6-X						
Body Inlet	Arc	Nozzle	Pressure Regulation*	Activation Type	Trajectory	Optional
3—1" 5—1½"	5 5—Part-circle and Full-circle In One	XX INF35—30, 31, 32, 33, 34, 35, 36, 37 INF55—51, 52, 53, 54, 55, 56, 57, 58, 59	X 6—65 psi 8—80 psi 1—100 psi	X 1—Standard Solenoid 2—Spike Guard™ Solenoid 3—Nickel-plated Spike Guard Solenoid 4—DC Latching Solenoid (DCLS) 6—Integrated Lynx® Smart Module w/DCLS	6 6—24-position TruJectory™	X 7—Effluent

**Example:** When specifying an INF35-6 Series Sprinkler with #34 nozzle, pressure regulation at 65 psi and Spike Guard you would specify: **INF35-346-26**

Note: Not all models available.

\* All sprinklers are equipped with the selectable pilot valve that allows settings at 50, 65, 80 and 100 psi.



















# INF-FLX35-6

## Performance Series Nozzles

### Performance Data



<b>Nozzle Set (30 to 33)</b>	<b>Nozzle Set 30</b>		<b>Nozzle Set 31</b>		<b>Nozzle Set 32</b>		<b>Nozzle Set 33</b>	
<b>Color</b>	 (White)		 (Yellow)		 (Blue)		 (Brown)	
<b>Part #</b>	102-2208		102-0725		102-0726		102-0727	
<b>Stator #</b>	102-6929 Blue		102-1939 White					
<b>Front</b>								
<b>Color</b>	(Blue)	(Gray)	(Black)	(Green)	(Black)	(Dark Red)	(Black)	(Dark Red)
<b>Part #</b>	102-2925	102-2910	102-6941	118-6697	102-6941	118-6698	102-6941	118-6698
<b>Back Nozzle Positions</b>								
<b>Color</b>	(Red)		(Red)		(Red)		(Red)	
<b>Part #</b>	102-4335		102-4335		102-4335		102-4335	
<b>Part Circle Trujectory 35-6</b>								
<b>Pressure (PSI)</b>	<b>Radius (FT)</b>	<b>Flow (GPM)</b>	<b>Radius (FT)</b>	<b>Flow (GPM)</b>	<b>Radius (FT)</b>	<b>Flow (GPM)</b>	<b>Radius (FT)</b>	<b>Flow (GPM)</b>
50	42	7.6	53	13.9	58	19.4		
65	45	8.3	55	15.9	60	22.3	65	24.3
80	46	9.2	59	17.6	64	24.5	69	26.8
100	48	10.1	61	19.5	68	27.3	73	30.0

### INF-FLX35-6 Nozzle Apex

Pressure	Nozzle	Apex at 15°	Apex at 25°
65 psi	31	6' @ 51'	13' @ 54'
	32	6' @ 51'	11' @ 64'
	33	7' @ 59'	13' @ 68'
	34	8' @ 63'	15' @ 74'
	35	9' @ 66'	15' @ 76'
80 psi	36	8' @ 75'	18' @ 83'
	37	9' @ 74'	19' @ 82'

### Nozzle Angle Installation Key

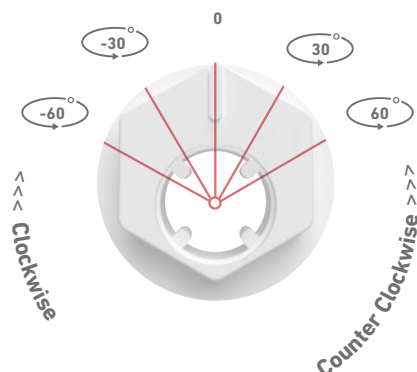















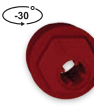

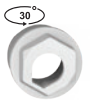

# INF-FLX35-6

## Performance Series Nozzles



<b>Nozzle Set (34 to 37)</b>	<b>Nozzle Set 34</b>		<b>Nozzle Set 35</b>		<b>Nozzle Set 36</b>		<b>Nozzle Set 37</b>	
<b>Color</b>	 (Orange)		 (Green)		 (Gray)		 (Black)	
<b>Part #</b>	102-7002		102-0729		102-0730		102-4261	
<b>Stator #</b>	102-1939 White		118-7282 Red, Pink					
<b>Front</b>	 30°	 -30°		 -30°		 -30°	 30°	 -30°
<b>Color</b>	(Black)	(Dark Red)	(White)	(Purple)	(White)	(Lt. Blue)	(White)	(Lt. Blue)
<b>Part #</b>	102-6941	118-6698	102-6940	118-6699	102-6940	118-6700	102-6940	118-6700
<b>Back Nozzle Positions</b>								
<b>Color</b>	(Red)		(Red)		(Red)		(Red)	
<b>Part #</b>	102-4335		102-4335		102-4335		102-4335	
<b>Part Circle TruJectory 35-6</b>								
<b>Pressure (PSI)</b>	<b>Radius (FT)</b>	<b>Flow (GPM)</b>	<b>Radius (FT)</b>	<b>Flow (GPM)</b>	<b>Radius (FT)</b>	<b>Flow (GPM)</b>	<b>Radius (FT)</b>	<b>Flow (GPM)</b>
50								
65	70	26.2	75	34.6				
80	73	28.6	79	38.6	80	41.5	85	43.8
100	76	32.0	84	43.1	85	46.5	90	49.3

**Not recommended at these pressures.** Radius shown in feet. Toro® recommends the use of a 1¼" swing joint at flows over 25-gpm (95-LPM). Sprinkler radius data collected in Toro's zero wind test facility per ASAE standard S398.1. Actual site conditions must be considered when selecting the appropriate nozzle. All sprinklers are equipped with the selectable pilot valve that allows settings at 50, 65, 80 and 100 psi.



### Main Nozzle Adapter (118-1521)

A wide assortment of intermediate and inner nozzles for use in the main nozzle adapter and back nozzle position provide unmatched nozzle flexibility.













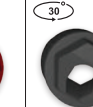

# INF-FLX55-6

## Performance Series Nozzles

### Performance Data



Nozzle Set (51 to 54)	Nozzle Set 51		Nozzle Set 52		Nozzle Set 53		Nozzle Set 54	
<b>Color</b>	(Yellow)		(Blue)		(Brown)		(Orange)	
<b>Part #</b>	102-0725		102-0726		102-0727		102-7002	
<b>Stator #</b>	102-1939 White							
<b>Front</b>								
<b>Color</b>	(Black)	(Green)	(Black)	(Dark Red)	(Black)	(Dark Red)	(Black)	(Purple)
<b>Part #</b>	102-6941	118-6697	102-6941	118-6698	102-6941	118-6698	102-6941	118-6699
<b>Back Nozzle Positions</b>								
<b>Color</b>	(Red)		(Red)		(Red)		(Red)	
<b>Part #</b>	102-4335		102-4335		102-4335		102-4335	
<b>Part Circle TruJectory 55-6</b>								
<b>Pressure (PSI)</b>	<b>Radius (FT)</b>	<b>Flow (GPM)</b>	<b>Radius (FT)</b>	<b>Flow (GPM)</b>	<b>Radius (FT)</b>	<b>Flow (GPM)</b>	<b>Radius (FT)</b>	<b>Flow (GPM)</b>
50	53	14.5	58	19.9				
65	55	16.5	60	22.9	65	25.4	70	26.9
80	59	18.2	65	25	70	27.6	73	30.4
100	61	20.3	70	28	74	30.7	76	33.9

### INF-FLX55-6 Nozzle Apex

Pressure	Nozzle	Apex at 15°	Apex at 25°
65 psi	51	6' @ 51'	13' @ 54'
	52	6' @ 51'	11' @ 64'
	53	7' @ 59'	13' @ 68'
	54	8' @ 63'	15' @ 74'
	55	9' @ 66'	15' @ 76'
80 psi	56	8' @ 75'	18' @ 83'
	57	9' @ 74'	19' @ 82'
	58	10' @ 82'	18' @ 87'
	59	11' @ 81'	21' @ 91'

### Nozzle Angle Installation Key

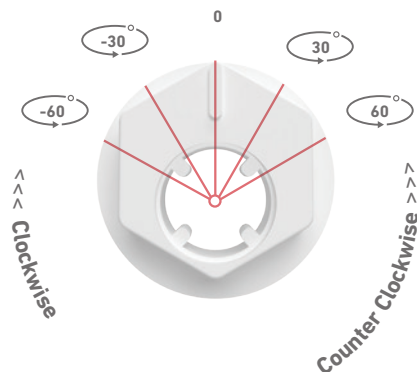





















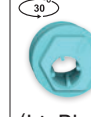

# INF-FLX55-6

## Performance Series Nozzles



<b>Nozzle Set (55 to 59)</b>	<b>Nozzle Set 55</b>		<b>Nozzle Set 56</b>		<b>Nozzle Set 57</b>		<b>Nozzle Set 58</b>		<b>Nozzle Set 59</b>	
<b>Color</b>	 (Green)		 (Gray)		 (Black)		 (Red)		 (Beige)	
<b>Part #</b>	102-0729		102-0730		102-4261		102-4260		102-4259	
<b>Stator #</b>	118-7282 Red, Pink								102-1941 Red, Black (Spokes)	
<b>Front</b>	 (White)	 (Purple)	 (White)	 (Purple)	 (White)	 (Purple)	 (Black)	 (Lt. Blue)	 (Black)	 (Red)
<b>Part #</b>	102-6940	118-6699	102-6940	118-6699	102-6940	118-6699	102-6941	118-6700	102-6941	102-6944
<b>Back Nozzle Positions</b>	 (Red)		 (Red)		 (Red)		 (Red)		 (Red)	
<b>Color</b>	(Red)		(Red)		(Red)		(Red)		(Red)	
<b>Part #</b>	102-4335		102-4335		102-4335		102-4335		102-4335	
<b>Part Circle Trujectory 55-6</b>										
<b>Pressure (PSI)</b>	<b>Radius (FT)</b>	<b>Flow (GPM)</b>	<b>Radius (FT)</b>	<b>Flow (GPM)</b>	<b>Radius (FT)</b>	<b>Flow (GPM)</b>	<b>Radius (FT)</b>	<b>Flow (GPM)</b>	<b>Radius (FT)</b>	<b>Flow (GPM)</b>
50										
65	75	35.1								
80	80	39.3	80	40.7	85	43.2	88	51.0	95	60.1
100	85	43.9	88	46.1	90	49.8	90	56.3	100	66.3

**Not recommended at these pressures.** Radius shown in feet. Toro® recommends the use of a 1¼" swing joint at flows over 25-gpm (95-LPM). Sprinkler radius data collected in Toro's zero wind test facility per ASAE standard S398.1. Actual site conditions must be considered when selecting the appropriate nozzle. All sprinklers are equipped with the selectable pilot valve that allows settings at 50, 65, 80 and 100 psi.



### Main Nozzle Adapter (118-1521)

A wide assortment of intermediate and inner nozzles for use in the main nozzle adapter and back nozzle position provide unmatched nozzle flexibility.



# INFINITY<sup>®</sup> 35-6/55-6 Series Golf Sprinklers

## Trajectory Performance

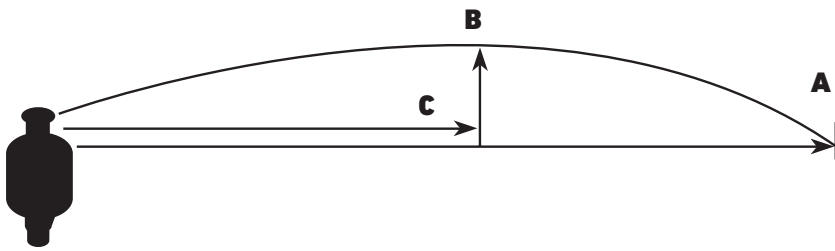

### INFINITY 35-6 Trajectory Performance

Nozzle/psi	#31 Nozzle @ 65 psi						#32 Nozzle @ 65 psi						#33 Nozzle @ 65 psi					
Trajectory	7°	10°	15°	20°	25°	30°	7°	10°	15°	20°	25°	30°	7°	10°	15°	20°	25°	30°
"A" Radius	46'	46'	50'	53'	54'	50'	46'	49'	51'	55'	63'	54'	54'	56'	59'	62'	66'	61'
"B" Spray Height	4'	4'	5'	8'	11'	13'	3'	4'	6'	9'	12'	15'	4'	5'	7'	9'	13'	15'
"C" Distance from Head	25'	25'	26'	33'	33'	33'	20'	24'	28'	34'	34'	34'	23'	28'	32'	34'	35'	35'

Nozzle/psi	#34 Nozzle @ 65 psi						#35 Nozzle @ 65 psi						#36 Nozzle @ 80 psi					
Trajectory	7°	10°	15°	20°	25°	30°	7°	10°	15°	20°	25°	30°	7°	10°	15°	20°	25°	30°
"A" Radius	58'	60'	63'	67'	74'	70'	59'	61'	64'	70'	76'	74'	64'	68'	76'	80'	84'	82'
"B" Spray Height	4'	4'	6'	11'	14'	17'	4'	5'	7'	11'	15'	17'	5'	7'	9'	14'	17'	22'
"C" Distance from Head	24'	26'	35'	39'	39'	39'	30'	32'	36'	43'	43'	43'	25'	38'	40'	45'	49'	45'

Nozzle/psi	#37 Nozzle @ 80 psi					
Trajectory	7°	10°	15°	20°	25°	30°
"A" Radius	65'	69'	78'	82'	86'	84'
"B" Spray Height	5'	7'	9'	14'	18'	22'
"C" Distance from Head	30'	39'	41'	46'	50'	46'

### INFINITY 55-6 Trajectory Performance

Nozzle/psi	#51 Nozzle @ 65 psi						#52 Nozzle @ 65 psi						#53 Nozzle @ 65 psi					
Trajectory	7°	10°	15°	20°	25°	30°	7°	10°	15°	20°	25°	30°	7°	10°	15°	20°	25°	30°
"A" Radius	46'	46'	51'	53'	54'	50'	49'	50'	51'	55'	64'	65'	54'	56'	59'	62'	68'	61'
"B" Spray Height	4'	4'	6'	10'	13'	15'	4'	4'	6'	9'	11'	13'	5'	6'	7'	9'	13'	15'
"C" Distance from Head	26'	27'	32'	38'	40'	41'	22'	26'	31'	35'	34'	30'	30'	33'	32'	35'	37'	37'

Nozzle/psi	#54 Nozzle @ 65 psi						#55 Nozzle @ 65 psi						#56 Nozzle @ 80 psi					
Trajectory	7°	10°	15°	20°	25°	30°	7°	10°	15°	20°	25°	30°	7°	10°	15°	20°	25°	30°
"A" Radius	58'	60'	63'	67'	74'	70'	59'	62'	66'	70'	76'	77'	72'	73'	75'	82'	85'	82'
"B" Spray Height	5'	6'	8'	10'	15'	17'	6'	6'	9'	11'	15'	17'	5'	7'	9'	14'	17'	22'
"C" Distance from Head	31'	34'	40'	41'	41'	42'	34'	36'	43'	45'	45'	45'	25'	38'	40'	45'	49'	45'

Nozzle/psi	#57 Nozzle @ 80 psi						#58 Nozzle @ 80 psi						#59 Nozzle @ 80 psi					
Trajectory	7°	10°	15°	20°	25°	30°	7°	10°	15°	20°	25°	30°	7°	10°	15°	20°	25°	30°
"A" Radius	72'	74'	77'	83'	89'	85'	75'	77'	83'	87'	92'	88'	77'	78'	84'	89'	96'	92'
"B" Spray Height	5'	7'	9'	14'	18'	22'	6'	7'	10'	15'	18'	22'	7'	8'	11'	16'	21'	25'
"C" Distance from Head	30'	39'	41'	46'	50'	46'	38'	40'	43'	47'	52'	48'	42'	44'	45'	47'	53'	49'

Information is for reference only. Actual results may vary.









# INFINITY<sup>®</sup> 35/55

## Series Golf Sprinklers

### Specifications

#### Operational

- **Inlet:**
  - INF35: 1" ACME
  - INF55: 1½" ACME
- **Radius:**
  - INF35: 43' – 83'
  - INF55: 55' – 92'
- **Flow Rate:**
  - INF35: 8.2 – 47.3 gpm
  - INF55: 14.1 - 61.3 gpm
- **Precipitation Rates:**
  - INF35: Minimum - .41"/hr; Maximum - .45"/hr
  - INF55: Minimum - .46"/hr; Maximum - .58"/hr
- **Pilot Valve:** Selectable at 50, 65, 80 and 100 psi
- **Recommended Operating Pressure Range:** 65-100 psi (maximum -150 psi and minimum - 40 psi)
- **Activation types – Electric Valve-in-Head:**
  - **Standard Solenoid:**
    - 24 VAC, 50/60 Hz
    - Inrush: 0.30 A
    - Holding 0.20 A
  - **Spike Guard™ Solenoid:**
    - 24 VAC, 50/60 Hz
    - Inrush: 0.12 A
    - Holding 0.10 A
  - **Nickel-Plated Spike Guard Solenoid:**
    - 24 VAC, 50/60 Hz
    - Inrush: 0.12 A
    - Holding 0.10 A
  - **DC Latching Solenoid (DCLS):**
    - Momentary low voltage pulse
  - **Integrated Lynx® Smart Module with DCLS:**
    - Momentary low voltage pulse

#### Additional Features

- **INF35 has eight nozzle variations** (30, 31, 32, 33, 34, 35, 36 and 37)
- **INF55 has nine nozzle variations** (51, 52, 53, 54, 55, 56, 57, 58 and 59)
- Three in-line nozzles, rotating stream pattern
- Two back nozzle positions
- **Stator variations: 3**
- Ratcheting riser
- Nozzle base clutching

#### Warranty

- Three years
- Five years when installed with Toro® Swing Joints

#### Dimensions

- **SMART ACCESS® Cover and Compartment Diameter:**
  - INF35-6: 7 5/8"
  - INF55-6: 7 5/8"
- **Body height:**
  - INF35: 10"
  - INF55: 11 3/8"
- **Weight:**
  - INF35: 4.26 lbs.
  - INF55: 5.08 lbs.
- **Weight – Integrated with Lynx Smart Module:**
  - INF35: 4.95 lbs.
  - INF55: 5.71 lbs.
- **Pop-up height to nozzle: 3¼"**



# INFINITY® 35/55 Series Golf Sprinklers



### Set a course apart with Toro's unique, customizable distance markers

- White (118-6234) and Yellow (118-6235) color options provide excellent visibility
- Customizable with any graphic image
- Multiple number and orientation options available
- Any font style
- Easy snap-in installation into any INFINITY golf sprinkler



#### INF35 Conversion Upgrades

MODELS	DESCRIPTION
• INF35-3134	INF35-6 w/31-34 Nozzles (33 Nozzle Installed)
• INF35-3537	INF35-6 w/35-37 Nozzles (35 Nozzle Installed)
• INF35-3134E	INF35-6 w/31-34 Nozzles (33 Nozzle Installed), Effluent
• INF35-3537E	INF35-6 w/35-37 Nozzles (35 Nozzle Installed), Effluent



#### INF55 Conversion Upgrades

MODELS	DESCRIPTION
• INF55-5154	INF55-6 w/51-54 Nozzles (53 Nozzle Installed)
• INF55-5558	INF55-6 w/55-58 Nozzles (55 Nozzle Installed)
• INF55-59	INF55-6 w/59 Nozzle Installed
• INF55-5154E	INF55-6 w/51-54 Nozzles (53 Nozzle Installed), Effluent
• INF55-5558E	INF55-6 w/55-58 Nozzles (55 Nozzle Installed), Effluent
• INF55-59E	INF55-6 w/59 Nozzle Installed Effluent



#### Smart Access®

Provides top accessibility to all critical components.

- ✓ No digging or unsightly turf repair scars
- ✓ No buried wire splices or ground faults
- ✓ Pilot valve removable with water "ON"
- ✓ Lower long term cost of ownership
- ✓ Customizable marker
- ✓ Replaceable cover if damaged
- ✓ Increased labor efficiency

### Specifying Information — INFINITY 35 & INFINITY 55

INFX5-XXX-XX					
Body Inlet	Arc	Nozzle	Pressure Regulation*	Activation Type	Optional
INF X	5	XX	X	X	X
3—1" 5—1½"	5—Part-circle and Full-circle In One	INF35—30, 31, 32, 33, 34, 35, 36, 37 INF55—51, 52, 53, 54, 55, 56, 57, 58, 59	6—65 psi 8—80 psi 1—100 psi	1—Standard Solenoid 2—Spike Guard™ Solenoid 3—Nickel-plated Spike Guard Solenoid 4—DC Latching Solenoid (DCLS) 6—Integrated Lynx® Smart Module w/DCLS	7—Effluent

**Example:** When specifying an INF35 Series Sprinkler with #34 nozzle, pressure regulation at 65 psi and Spike Guard you would specify: **INF35-346-2**

Note: Not all models available.

\* All sprinklers are equipped with the selectable pilot valve that allows settings at 50, 65, 80 and 100 psi.



# INF-FLX35

## Performance Series Nozzles

### Performance Data



Nozzle Set (30 to 33)	Nozzle Set 30		Nozzle Set 31		Nozzle Set 32		Nozzle Set 33	
Color	(White)		(Yellow)		(Blue)		(Brown)	
Part #	102-2208		102-0725		102-0726		102-0727	
Stator #	102-6929 Blue		102-1939 White					
Front								
Color	(Yellow)	(Beige)	(Green)	(Blue)	(Green)	(Blue)	(Green)	(Blue)
Part #	102-5670	102-6942	102-6531	102-2925	102-6531	102-6947	102-6531	102-6947
Back Nozzle Positions								
Color	(Red)	(Red)	(Red)	(Red)	(Red)	(Red)	(Red)	(Red)
Part #	102-4335	102-4335	102-4335	102-4335	102-4335	102-4335	102-4335	102-4335
<b>Part Circle Dual Trajectory 35</b>								
Pressure (PSI)	Radius (FT)	Flow (GPM)	Radius (FT)	Flow (GPM)	Radius (FT)	Flow (GPM)	Radius (FT)	Flow (GPM)
50	43	8.2	52	13.8	57	17.9		
65	45	10.0	55	15.9	60	20.4	65	22.6
80	46	11.5	57	17.6	63	22.7	67	24.9
100	47	13.4	58	19.6	67	25.2	70	27.8

### INF-FLX35 Nozzle Apex

Pressure	Nozzle	Apex at 15°	Apex at 25°
65 psi	31	6' @ 51'	13' @ 54'
	32	6' @ 51'	11' @ 64'
	33	7' @ 59'	13' @ 68'
	34	8' @ 63'	15' @ 74'
	35	9' @ 66'	15' @ 76'
80 psi	36	8' @ 75'	18' @ 83'
	37	9' @ 74'	19' @ 82'

### Nozzle Angle Installation Key

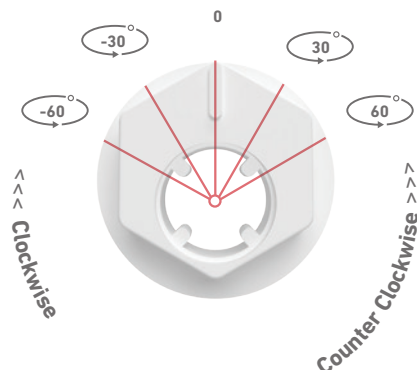















# INF-FLX35

## Performance Series Nozzles



<b>Nozzle Set (34 to 37)</b>	<b>Nozzle Set 34</b>		<b>Nozzle Set 35</b>		<b>Nozzle Set 36</b>		<b>Nozzle Set 37</b>	
<b>Color</b>	 (Orange)		 (Green)		 (Gray)		 (Black)	
<b>Part #</b>	102-7002		102-0729		102-0730		102-4261	
<b>Stator #</b>	102-1939 White		118-7282 Red, Pink					
<b>Front</b>								
<b>Color</b>	(Yellow)	(Purple)	(White)	(Yellow)	(White)	(Yellow)	(White)	(Yellow)
<b>Part #</b>	102-5670	118-6699	102-6940	102-6946	102-6940	102-6946	102-6940	102-6946
<b>Back Nozzle Positions</b>								
<b>Color</b>	(Red)							
<b>Part #</b>	102-4335	102-4335	102-4335	102-4335	102-4335	102-4335	102-4335	102-4335
<b>Part Circle Dual Trajectory 35</b>								
Pressure (PSI)	Radius (FT)	Flow (GPM)	Radius (FT)	Flow (GPM)	Radius (FT)	Flow (GPM)	Radius (FT)	Flow (GPM)
50								
65	70	25.6	75	34.2				
80	71	28.5	78	38	80	39.7	85	42.3
100	72	31.7	83	42.5	84	44.5	86	47.3

**Not recommended at these pressures.** Radius shown in feet. Toro® recommends the use of a 1 1/4" swing joint at flows over 25-gpm (95-LPM). Sprinkler radius data collected in Toro's zero wind test facility per ASAE standard S398.1. Actual site conditions must be considered when selecting the appropriate nozzle. All sprinklers are equipped with the selectable pilot valve that allows settings at 50, 65, 80 and 100 psi.



### Main Nozzle Adapter (118-1521)

A wide assortment of intermediate and inner nozzles for use in the main nozzle adapter and back nozzle position provide unmatched nozzle flexibility.















# INF-FLX55

## Performance Series Nozzles

### Performance Data



<b>Nozzle Set (51 to 54)</b>	<b>Nozzle Set 51</b>		<b>Nozzle Set 52</b>		<b>Nozzle Set 53</b>		<b>Nozzle Set 54</b>	
<b>Color</b>	 (Yellow)		 (Blue)		 (Brown)		 (Orange)	
<b>Part #</b>	102-0725		102-0726		102-0727		102-7002	
<b>Stator #</b>	102-1939 White							
<b>Front</b>								
<b>Color</b>	(Yellow)	(Brown)	(Green)	(Blue)	(Green)	(Blue)	(Yellow)	(Yellow)
<b>Part #</b>	102-5670	102-5671	102-6531	102-6947	102-6531	102-6947	102-5670	102-6884
<b>Back Nozzle Positions</b>								
<b>Color</b>	(Red)	(Red)	(Red)	(Red)	(Red)	(Red)	(Red)	(Red)
<b>Part #</b>	102-4335	102-4335	102-4335	102-4335	102-4335	102-4335	102-4335	102-4335
<b>Part Circle Dual Trajectory 55</b>								
<b>Pressure (PSI)</b>	<b>Radius (FT)</b>	<b>Flow (GPM)</b>	<b>Radius (FT)</b>	<b>Flow (GPM)</b>	<b>Radius (FT)</b>	<b>Flow (GPM)</b>	<b>Radius (FT)</b>	<b>Flow (GPM)</b>
50	53	13.9	58	18.1				
65	55	15.3	60	20.7	65	22.9	70	25.9
80	57	17.8	64	23.1	68	25.4	71	29.0
100	59	19.8	68	25.8	72	28.6	73	32.4

### INF-FLX55 Nozzle Apex

Pressure	Nozzle	Apex at 15°	Apex at 25°
65 psi	51	6' @ 51'	13' @ 54'
	52	6' @ 51'	11' @ 64'
	53	7' @ 59'	13' @ 68'
	54	8' @ 63'	15' @ 74'
	55	9' @ 66'	15' @ 76'
80 psi	56	8' @ 75'	18' @ 83'
	57	9' @ 74'	19' @ 82'
	58	10' @ 82'	18' @ 87'
	59	11' @ 81'	21' @ 91'

### Nozzle Angle Installation Key

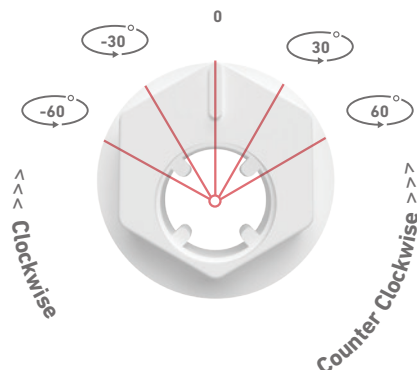



















# INF-FLX55

## Performance Series Nozzles



<b>Nozzle Set (55 to 59)</b>	<b>Nozzle Set 55</b>		<b>Nozzle Set 56</b>		<b>Nozzle Set 57</b>		<b>Nozzle Set 58</b>		<b>Nozzle Set 59</b>	
<b>Color</b>	 (Green)		 (Gray)		 (Black)		 (Red)		 (Beige)	
<b>Part #</b>	102-0729		102-0730		102-4261		102-4260		102-4259	
<b>Stator #</b>	118-7282 Red, Pink								102-1941 Red, Black (Spokes)	
<b>Front</b>	 (White)	 (Yellow)	 (White)	 (Yellow)	 (White)	 (Yellow)	 (White)	 (Yellow)	 (White)	 (Yellow)
<b>Part #</b>	102-6940	102-6946	102-6940	102-6946	102-6940	102-6946	102-6940	102-6946	102-6940	102-6946
<b>Back Nozzle Positions</b>										
<b>Color</b>	(Red)									
<b>Part #</b>	102-4335	102-4335	102-4335	102-4335	102-4335	102-4335	102-4335	102-4335	102-4335	102-4335
<b>Part Circle Dual Trajectory 55</b>										
<b>Pressure (PSI)</b>	<b>Radius (FT)</b>	<b>Flow (GPM)</b>	<b>Radius (FT)</b>	<b>Flow (GPM)</b>	<b>Radius (FT)</b>	<b>Flow (GPM)</b>	<b>Radius (FT)</b>	<b>Flow (GPM)</b>	<b>Radius (FT)</b>	<b>Flow (GPM)</b>
50										
65	75	34.6								
80	79	38.5	80	40.0	83	42.9	85	49.0	89	58.1
100	83	43.0	85	45.1	87	48.1	88	54.8	95	64.6

**Not recommended at these pressures.** Radius shown in feet. Toro® recommends the use of a 1 1/4" swing joint at flows over 25-gpm (95-LPM). Sprinkler radius data collected in Toro's zero wind test facility per ASAE standard S398.1. Actual site conditions must be considered when selecting the appropriate nozzle. All sprinklers are equipped with the selectable pilot valve that allows settings at 50, 65, 80 and 100 psi.

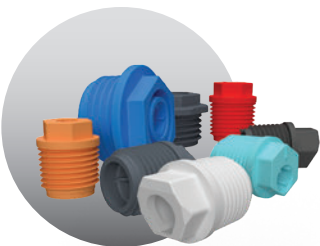

### Main Nozzle Adapter (118-1521)

A wide assortment of intermediate and inner nozzles for use in the main nozzle adapter and back nozzle position provide unmatched nozzle flexibility.



# INFINITY<sup>®</sup> 34/54

## Series Golf Sprinklers

### Specifications

#### Operational

- **Inlet:**
  - INF34: 1" ACME
  - INF54: 1½" ACME
- **Radius:**
  - INF45: 52' – 91'
  - INF54: 52' – 99'
- **Flow Rate:**
  - INF34: 13.0 – 46.9 gpm
  - INF54: 13.2 – 61.8 gpm
- **Precipitation Rates:**
  - INF34: Minimum - .33"/hr; Maximum - .55"/hr
  - INF54: Minimum - .33"/hr; Maximum - .61"/hr
- Pilot Valve: Selectable at 50, 65, 80 and 100 psi
- Recommended Operating Pressure Range: 65-100 psi (maximum -150 psi and minimum - 40 psi)
- Activation types – Electric Valve-in-Head:
  - **Standard Solenoid:**
    - 24 VAC, 50/60 Hz
    - Inrush: 0.30 A
    - Holding 0.20 A
  - **Spike Guard™ Solenoid:**
    - 24 VAC, 50/60 Hz
    - Inrush: 0.12 A
    - Holding 0.10 A
  - **Nickel-Plated Spike Guard Solenoid:**
    - 24 VAC, 50/60 Hz
    - Inrush: 0.12 A
    - Holding 0.10 A
  - **DC Latching Solenoid (DCLS):**
    - Momentary low voltage pulse
  - **Integrated Lynx® Smart Module with DCLS:**
    - Momentary low voltage pulse
- **Trajectory:** 25° or 15°

#### Additional Features

- Dual Trajectory adjustment on main nozzle - 25° or 15°
- Constant velocity full circle drive
- Radius reduction screw can effectively reduce the sprinkler throw down to 30'

#### Warranty

- Three years
- Five years when installed with Toro® Swing Joints

#### Dimensions

- **SMART ACCESS® Cover and Compartment Diameter:**
  - INF34: 7 5/8"
  - INF54-6: 7 5/8"
- **Body height:**
  - INF34: 10"
  - INF54: 11 3/8"
- **Weight:**
  - INF34: 4.26 lbs.
  - INF54: 5.08 lbs.
- **Weight – Integrated with Lynx Smart Module:**
  - INF34: 4.95 lbs.
  - INF54: 5.71 lbs.
- **Pop-up height to nozzle:** 3¼"



# INFINITY® 34/54 Series Golf Sprinklers



### Set a course apart with Toro's unique, customizable distance markers

- White (118-6234) and Yellow (118-6235) color options provide excellent visibility
- Customizable with any graphic image
- Multiple number and orientation options available
- Any font style
- Easy snap-in installation into any INFINITY golf sprinkler



### INF34 Conversion Upgrades

MODELS	DESCRIPTION
• INF34-3134	INF34 w/31-34 Nozzles (33 Nozzle Installed)
• INF34-3537	INF34 w/35-37 Nozzles (35 Nozzle Installed)
• INF34-3134E	INF34 w/31-34 Nozzles (33 Nozzle Installed), Effluent
• INF34-3537	INF34 w/35-37 Nozzles (35 Nozzle Installed), Effluent



### INF54 Conversion Upgrades

MODELS	DESCRIPTION
• INF54-5154	INF54 w/51-54 Nozzles (53 Nozzle Installed)
• INF54-5558	INF54 w/55-58 Nozzles (55 Nozzle Installed)
• INF54-59	INF54 w/59 Nozzle Installed
• INF54-5154E	INF54 w/51-54 Nozzles (53 Nozzle Installed), Effluent
• INF54-5558E	INF54 w/55-58 Nozzles (55 Nozzle Installed), Effluent
• INF54-59E	INF54 w/59 Nozzle Installed Effluent
• 102-5011	690 Adapter allows you to upgrade any 690 with FLX54 conversions
• 102-0950	Required to upgrade all 1.5" Series Sprinklers (650, 670, 680, 750, and 780)



### Smart Access®

Provides top accessibility to all critical components.

- ✓ No digging or unsightly turf repair scars
- ✓ No buried wire splices or ground faults
- ✓ Pilot valve removable with water "ON"
- ✓ Lower long term cost of ownership
- ✓ Customizable marker
- ✓ Replaceable cover if damaged
- ✓ Increased labor efficiency

### Specifying Information — INFINITY 34 & INFINITY 54

INF4-XXX-X-X					
Body Inlet	Arc	Nozzle	Pressure Regulation*	Activation Type	Optional
INF4	4	XX	X	X	X
3-1" 5-1/2"	4—Full Circle	INF34—31, 32, 33, 34, 35, 36, 37 INF54—51, 52, 53, 54, 55, 56, 57, 58, 59	6—65 psi 8—80 psi 1—100 psi	1—Standard Solenoid 2—Spike Guard™ Solenoid 3—Nickel-plated Spike Guard Solenoid 4—DC Latching Solenoid (DCLS) 6—Integrated Lynx® Smart Module w/DCLS	7—Effluent

Example: When specifying an INF34 Series Sprinkler with #34 nozzle, pressure regulation at 65 psi and Spike Guard you would specify: **INF34-346-2**

Note: Not all models available.

\* All sprinklers are equipped with the selectable pilot valve that allows settings at 50, 65, 80 and 100 psi.



# INF-FLX34

## Performance Series Nozzles

Performance



Nozzle Set (31 to 34)	Nozzle Set 31		Nozzle Set 32		Nozzle Set 33		Nozzle Set 34	
<b>Color</b>	(Yellow)		(Blue)		(Brown)		(Orange)	
<b>Part #</b>	102-0725		102-0726		102-0727		102-7002	
<b>Stator #</b>	102-6929 Blue							
<b>Front</b>								
<b>Color</b>	(Orange)	(Red)	(Red)	(Red)	(Red)	(Red)	(Red)	(Red)
<b>Part #</b>	102-2926	102-4335	102-4335	102-4335	102-4335	102-4335	102-4335	102-4335
<b>Back Nozzle Positions</b>								
<b>Color</b>	(White)	(Red)	(Yellow)	(Orange)	(Yellow)	(Red)	(Yellow)	(Beige)
<b>Part #</b>	102-6940	102-4335	102-6937	102-2926	102-6937	102-2928	102-6937	102-2929
<b>Full Circle Dual Trajectory 34</b>								
Pressure (PSI)	Radius (FT)	Flow (GPM)	Radius (FT)	Flow (GPM)	Radius (FT)	Flow (GPM)	Radius (FT)	Flow (GPM)
50	54	15.5	58	18.5				
65	55	18.0	60	21.1	65	25.4	70	28.9
80	59	19.9	67	23.6	71	28.5	75	32.4
100	61	22.2	70	26.5	76	32.0	79	36.0

### INF-FLX34 Nozzle Apex

Pressure	Nozzle	Apex at 15°	Apex at 25°
65 psi	31	6' @ 51'	13' @ 54'
	32	6' @ 51'	11' @ 64'
	33	7' @ 59'	13' @ 68'
	34	8' @ 63'	15' @ 74'
	35	9' @ 66'	15' @ 76'
80 psi	36	8' @ 75'	18' @ 83'
	37	9' @ 74'	19' @ 82'

### Nozzle Angle Installation Key

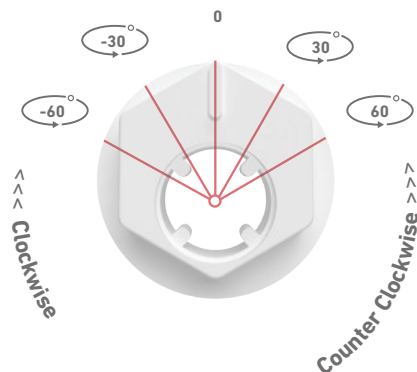



















# INF-FLX34

## Performance Series Nozzles



Nozzle Set (35 to 37)	Nozzle Set 35		Nozzle Set 36		Nozzle Set 37	
						
<b>Color</b>	(Green)		(Gray)		(Black)	
<b>Part #</b>	102-0729		102-0730		102-4261	
<b>Stator #</b>	102-1940 Red, Black (Circles)					
<b>Front</b>						
	(Red)	(Red)	(Brown)	(Red)	(Red)	(Lt. Blue)
<b>Part #</b>	102-4335	102-4335	102-6883	102-4335	102-4335	118-6700
<b>Back Nozzle Positions</b>						
<b>Color</b>	(Yellow)	(Beige)	(White)	(Beige)	(White)	(Beige)
<b>Part #</b>	102-6937	102-2929	102-6940	102-6942	102-6940	102-6942
<b>Full Circle Dual Trajectory 34</b>						
<b>Pressure (PSI)</b>	<b>Radius (FT)</b>	<b>Flow (GPM)</b>	<b>Radius (FT)</b>	<b>Flow (GPM)</b>	<b>Radius (FT)</b>	<b>Flow (GPM)</b>
50						
65	75	37.4				
80	82	41.3	80	46.8	85	52.3
100	86	46.0	87	52.1	89	58.5

**Not recommended at these pressures.** Radius shown in feet. Toro® recommends the use of a 1¼" swing joint at flows over 25-gpm (95-LPM). Sprinkler radius data collected in Toro's zero wind test facility per ASAE standard S398.1. Actual site conditions must be considered when selecting the appropriate nozzle. All sprinklers are equipped with the selectable pilot valve that allows settings at 50, 65, 80 and 100 psi.



### Main Nozzle Adapter (118-1521)

A wide assortment of intermediate and inner nozzles for use in the main nozzle adapter and back nozzle position provide unmatched nozzle flexibility.



# INF-FLX54

## Performance Series Nozzles

### Performance Data



<b>Nozzle Set (51 to 54)</b>	<b>Nozzle Set 51</b>	<b>Nozzle Set 52</b>	<b>Nozzle Set 53</b>	<b>Nozzle Set 54</b>				
<b>Color</b>	(Yellow)	(Blue)	(Brown)	(Orange)				
<b>Part #</b>	102-0725	102-0726	102-0727	102-7002				
<b>Stator #</b>	102-1939 White							
<b>Front</b>								
<b>Color</b>	(Orange)	(Red)	(Red)	(Red)	(Red)	(Red)	(Red)	(Red)
<b>Part #</b>	102-2926	102-4335	102-4335	102-4335	102-4335	102-4335	102-4335	102-4335
<b>Back Nozzle Positions</b>								
<b>Color</b>	(White)	(Red)	(Yellow)	(Orange)	(Yellow)	(Red)	(Yellow)	(Beige)
<b>Part #</b>	102-6940	102-4335	102-6937	102-2926	102-6937	102-2928	102-6937	102-2929
<b>Full Circle Dual Trajectory 54</b>								
<b>Pressure (PSI)</b>	<b>Radius (FT)</b>	<b>Flow (GPM)</b>	<b>Radius (FT)</b>	<b>Flow (GPM)</b>	<b>Radius (FT)</b>	<b>Flow (GPM)</b>	<b>Radius (FT)</b>	<b>Flow (GPM)</b>
50	54	15.9	60	18.9				
65	55	18.1	62	21.6	65	25.8	70	29.4
80	58	20.3	68	24.0	70	29.0	75	32.9
100	62	22.7	72	27.0	75	32.5	77	36.5

### INF-FLX54 Nozzle Apex

Pressure	Nozzle	Apex at 15°	Apex at 25°
65 psi	51	6' @ 51'	13' @ 54'
	52	6' @ 51'	11' @ 64'
	53	7' @ 59'	13' @ 68'
	54	8' @ 63'	15' @ 74'
	55	9' @ 66'	15' @ 76'
80 psi	56	8' @ 75'	18' @ 83'
	57	9' @ 74'	19' @ 82'
	58	10' @ 82'	18' @ 87'
	59	11' @ 81'	21' @ 91'

### Nozzle Angle Installation Key

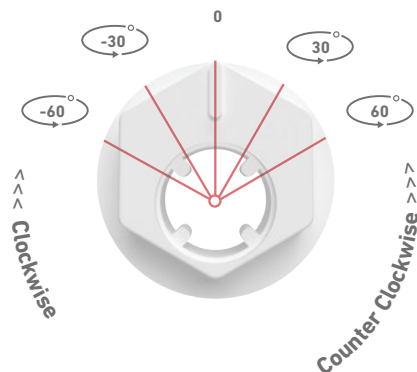

























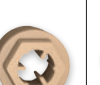

# INF-FLX54

## Performance Series Nozzles



Nozzle Set (55 to 59)	Nozzle Set 55		Nozzle Set 56		Nozzle Set 57		Nozzle Set 58		Nozzle Set 59	
<b>Color</b>	 (Green)		 (Gray)		 (Black)		 (Red)		 (Beige)	
<b>Part #</b>	102-0729		102-0730		102-4261		102-4260		102-4259	
<b>Stator #</b>	102-1940 Red, Black (Circles)								118-7282 Red, Pink	
<b>Front</b>	 (Brown)	 (Red)	 (Brown)	 (Red)	 (Red)	 (Lt. Blue)	 (White)	 (Red)	 (Red)	 (Red)
<b>Part #</b>	102-6883	102-4335	102-6883	102-4335	102-4335	118-6700	102-6940	102-4335	102-4335	102-6944
<b>Back Nozzle Positions</b>	 (White)	 (Beige)	 (White)	 (Beige)	 (White)	 (Beige)	 (Beige)	 (Gray)	 (White)	 (Red)
<b>Part #</b>	102-6940	102-6942	102-6940	102-6942	102-6940	102-6942	102-6942	102-6945	102-6940	102-4335
<b>Full Circle Dual Trajectory 54</b>										
<b>Pressure (PSI)</b>	<b>Radius (FT)</b>	<b>Flow (GPM)</b>	<b>Radius (FT)</b>	<b>Flow (GPM)</b>	<b>Radius (FT)</b>	<b>Flow (GPM)</b>	<b>Radius (FT)</b>	<b>Flow (GPM)</b>	<b>Radius (FT)</b>	<b>Flow (GPM)</b>
50										
65	75	40.8								
80	79	45.6	80	47.3	85	52.9	85	57.9	97	60.7
100	84	50.9	87	53.0	90	59.1	94	65.4	104	67.4

**Not recommended at these pressures.** Radius shown in feet. Toro® recommends the use of a 1 1/4" swing joint at flows over 25-gpm (95-LPM). Sprinkler radius data collected in Toro's zero wind test facility per ASAE standard S398.1. Actual site conditions must be considered when selecting the appropriate nozzle. All sprinklers are equipped with the selectable pilot valve that allows settings at 50, 65, 80 and 100 psi.



### Main Nozzle Adapter (118-1521)

A wide assortment of intermediate and inner nozzles for use in the main nozzle adapter and back nozzle position provide unmatched nozzle flexibility.



# INFINITY® RAZOR™ KITS

## Specifications



### Available in 1" & 1.5" Models

Model	Description
RAZOR-10-1	Razor Kit, 1" INFINITY, Stage 1 with 1.5" screws and pilot valve stacker
RAZOR-10-2	Razor Kit, 1" INFINITY, Stage 2 with 2" screws and pilot valve stacker
RAZOR-10-3	Razor Kit, 1" INFINITY, Stage 3 with 2.5" screws and pilot valve stacker
RAZOR-15-1	Razor Kit, 1.5" INFINITY, Stage 1 with 1.5" screws and pilot valve stacker
RAZOR-15-2	Razor Kit, 1.5" INFINITY, Stage 2 with 2" screws and pilot valve stacker
RAZOR-15-3	Razor Kit, 1.5" INFINITY, Stage 3 with 2.5" screws and pilot valve stacker

### INFINITY® Razor™ Kits

Extend the frequency of digging up & leveling sprinklers components

- ✓ Eliminates sprinkler interference
- ✓ Eliminates trip hazards
- ✓ Enhances course appearance
- ✓ Huge labor savings – no digging required!
- ✓ Retention features – hardware never gets lost
- ✓ Smart Access® compartment enables access to pilot valve, Lynx® Smart Module, wire splices and more

#### Pilot Valve stacker retention feature



Screw retention features (3 places)





# INFINITY® STEALTH™ KITS

## Specifications

### STEALTH™ Kit Models

**STEALTH-T** Kit attaches to INFINITY Series sprinklers with 24-position main nozzle adjustment capability

**STEALTH-D** Kit attaches to INFINITY Series sprinklers with dual trajectory main nozzle adjustment capability

- ✓ Eliminates sprinkler interference
- ✓ Enhances course appearance
- ✓ Natural turf atop sprinkler
- ✓ Kit fits existing INFINITY sprinklers
- ✓ Easy access to arc adjustment, snap rings, riser removal assembly, valve and rock screen
- ✓ Smart Access® compartment enables access to Pilot valve, Lynx® Smart Module, wire splices & more
- ✓ Access to manual selector and TruJectory™ adjuster with minimal turf/soil displacement
- ✓ Turf cup grass can be grown in a nursery prior to being installed onto the sprinkler





**TORO.**

# Golf Sprinklers, Sprays, & Subsurface Drip

*Water Precisely Where You Want It*



Model	FLX35/55-6	FLX35/55	FLX34/54
<b>Catalog Pages</b>	<b>47-53</b>	<b>55-60</b>	<b>61-66</b>
Radius	42'-100'	43'-92'	52'-99'
Short Radius (mainless)	25'-51'	25'-50'	
Radius Reduction Screw		Optional	Optional
Back Nozzle Capable	X	X	
Inlet Size	1" & 1½" ACME	1" & 1½" ACME	1" & 1½" ACME
Turf	X	X	X
High Wind	X	X	X
LSM 2-wire Systems	X	X	X
Normally Open Hydraulic System	X <sup>1</sup>	X <sup>1</sup>	X <sup>1</sup>
Spike Guard™ Solenoid	X	X	X
Full Circle	X	X	X
Part-circle Adjustable	X	X	
Part/Full Circle In One	40°-330° & 360°	40°-330° & 360°	
Ratcheting Riser	X	X	
Check Valve	X	X	X
Effluent Water Option	X	X	X
Trajectory Adjustment	7°-30°	25° & 15°	25° & 15°
Nozzle Base Clutching	X	X	
Warranty	3 Years/5 Years*	3 Years/5 Years*	3 Years/5 Years*

*\*When purchased and installed with Toro® Swing Joints.*

*X<sup>1</sup>-Complete sprinkler requires the purchase and assembly of riserless bodies and conversions.*

*# NPT and BSP models available as riserless bodies only.*



Model	FLEX800™ B SERIES	T7 Rotor	690	590GF
<b>Catalog Pages</b>	<b>67-68</b>	<b>73-74</b>	<b>75-76</b>	<b>77</b>
<b>Radius</b>	25'-95'	Low-flow: 38'-56' High-flow: 46'-75'	87'-108'	2'-26'
<b>Short Radius (mainless)</b>	X	X		X
<b>Radius Reduction Screw</b>	Optional	X		X
<b>Back Nozzle Capable</b>	X			
<b>Inlet Size</b>	1" NPT, BSP, ACME	1" ACME	1½" NPT	1/2" NPT
<b>Flow Range</b>	7.1-56.3 gpm	Low-flow: 1.7-12.7 gpm High-flow: 6.8-30.5 gpm	51.0-82.2 gpm	.05-4.5 gpm
<b>Recommended Operating Pressure</b>	50-100 psi	40-100 psi	80-100 psi	20-50 psi
<b>Turf</b>	X	X	X	X
<b>High Wind</b>	X		X	
<b>Low Pressure</b>		X		X
<b>Normally Open Hydraulic System</b>			X	
<b>Full Circle</b>	X	X	1 and 2 Speed	X
<b>Part-circle Adjustable</b>	X	X		X
<b>Part-circle Fixed</b>			90° and 180°	X
<b>Part/Full Circle In One</b>	40°-330° & 360°	X		X
<b>Ratcheting Riser</b>	FLX35-6B/FLX35B			X
<b>Check Valve</b>	X	X	X	X
<b>Effluent Water Option</b>	X	X		X
<b>Trajectory Adjustment</b>	7°-30° / 25° & 15°			
<b>Warranty</b>	3 Years/5 Years*	5 Years	3 Years/5 Years*	3 Years

\*When purchased and installed with Toro® Swing Joints.



# FLEX800™ 35-6/55-6 Series Golf Sprinklers

## Specifications

### Operational

- **Inlet:**
  - FLX35-6: 1" ACME
  - FLX55-6: 1½" ACME
- **Radius:**
  - FLX35-6: 42' – 92'
  - FLX55-6: 52' – 100'
- **Flow Rate:**
  - FLX35-6: 7.1 – 45.3 gpm
  - FLX55-6: 13.9 – 61.1 gpm
- **Precipitation Rates:**
  - FLX35-6: Minimum - .37"/hr; Maximum - .53"/hr
  - FLX55-6: Minimum - .43"/hr; Maximum - .60"/hr
- **Pilot Valve:** Selectable at 50, 65, 80 and 100 psi
- **Recommended Operating Pressure Range:** 65-100 psi (maximum -150 psi and minimum - 40 psi)
- **Activation types – Electric Valve-in-Head:**
  - **Standard Solenoid:**
    - 24 VAC, 50/60 Hz
    - Inrush: 0.30 A
    - Holding 0.20 A
  - **Spike Guard™ Solenoid:**
    - 24 VAC, 50/60 Hz
    - Inrush: 0.12 A
    - Holding 0.10 A
  - **Nickel-Plated Spike Guard Solenoid:**
    - 24 VAC, 50/60 Hz
    - Inrush: 0.12 A
    - Holding 0.10 A
  - **DC Latching Solenoid (DCLS):**
    - Momentary low voltage pulse
  - **Integrated Lynx® Smart Module with DCLS:**
    - Momentary low voltage pulse
- Trajectory: 24 positions from 7° - 30° in 1° increments

### Additional Features

- **FLX35-6 has eight nozzle variations** (30, 31, 32, 33, 34, 35, 36 and 37)
- **FLX55-6 has nine nozzle variations** (51, 52, 53, 54, 55, 56, 57, 58 and 59)
- Four in-line nozzles, rotating stream pattern
- One back nozzle position
- Stator variations: FLX35-6 – 3 and FLX55-6 – 3
- Ratcheting riser
- Nozzle base clutching

### Warranty

- Three years
- Five years when installed with Toro® Swing Joints

### FLX35-6 Conversion Upgrades

MODELS	DESCRIPTION
• FLX35-6-3134	FLX35-6 w/31-34 Nozzles (33 Nozzle Installed)
• FLX35-6-3537	FLX35-6 w/35-37 Nozzles (35 Nozzle Installed)
• FLX35-6-3134E	FLX35-6 w/31-34 Nozzles (33 Nozzle Installed), Effluent
• FLX35-6-3537E	FLX35-6 w/35-37 Nozzles (35 Nozzle Installed), Effluent



### FLX55-6 Conversion Upgrades — Ribbed Body

MODELS	DESCRIPTION
• FLX55-6-5154	FLX55-6 w/51-54 Nozzles (53 Nozzle Installed)
• FLX55-6-5558	FLX55-6 w/55-58 Nozzles (55 Nozzle Installed)
• FLX55-6-59	FLX55-6 w/59 Nozzle Installed
• FLX55-6-5154E	FLX55-6 w/51-54 Nozzles (53 Nozzle Installed), Effluent
• FLX55-6-5558E	FLX55-6 w/55-58 Nozzles (55 Nozzle Installed), Effluent
• FLX55-6-59E	FLX55-6 w/59 Nozzle Installed, Effluent
• 102-5011	690 Adapter allows you to upgrade any 690 with FLX55-6 conversions
• 102-0950	Required to upgrade all 650, 670, 680, 750, and 780 Series Sprinklers





# FLEX800™ 35-6/55-6 Series Golf Sprinklers

## Dimensions

- **Body Flange Diameter:**
  - FLX35-6: 6 1/2"
  - FLX55-6: 7 1/2"
- **Body height:**
  - FLX35-6: 10"
  - FLX55-6: 11 3/8"
- **Weight:**
  - FLX35-6: 2.94 lbs.
  - FLX55-6: 3.61 lbs.
- **Weight Integrated Lynx Smart Module**
  - FLX35-6: 3.63 lbs.
  - FLX55-6: 4.30 lbs.
- **Pop-up height to nozzle: 3 1/4"**



## Trajectory – 24 Positions

From 7° - 30° in 1° increments put water where you want it. Adjust from the top of the sprinkler in seconds, wet or dry. This flexibility lets you tackle every obstacle on the course; wind, trees, bunkers, mounds and more.

## FLX55-6 Conversion Upgrades — Ribless Body

MODELS	DESCRIPTION
• FLX55-6-5154R	FLX55-6 w/51–54 Nozzles (53 Nozzle Installed)
• FLX55-6-5558R	FLX55-6 w/55–58 Nozzles (55 Nozzle Installed)
• FLX55-6-59R	FLX55-6 w/59 Nozzle Installed
• FLX55-6-5154RE	FLX55-6 w/51–54 Nozzles (53 Nozzle Installed), Effluent
• FLX55-6-5558RE	FLX55-6 w/55–58 Nozzles (55 Nozzle Installed), Effluent
• FLX55-6-59RE	FLX55-6 w/59 Nozzle Installed, Effluent



## Specifying Information — FLEX800 35-6/55-6

FLXX5-XXX-X6-X						
Body Inlet	Arc	Nozzle	Pressure Regulation*	Activation Type	Trajectory	Optional
<b>FLXX</b>	<b>5</b>	<b>XX</b>	<b>X</b>	<b>X</b>	<b>6</b>	<b>X</b>
3–1" 5–1 1/2"	5—Part-circle Full-circle In One	<b>FLX35</b> —30, 31, 32, 33, 34, 35, 36, 37 <b>FLX55</b> —51, 52, 53, 54, 55, 56, 57, 58, 59	6—65 psi 8—80 psi 1—100 psi	1—Standard Solenoid 2—Spike Guard™ Solenoid 3—Nickel-plated Spike Guard Solenoid 4—DC Latching Solenoid (DCLS) 6—Integrated Lynx® Smart Module w/DCLS	6—24-position TruJectory™	7—Effluent
<b>Example:</b> When specifying an FLX35-6 Series Sprinkler with #34 nozzle, pressure regulation at 65 psi and Spike Guard you would specify: <b>FLX35-346-26</b>						

Note: Not all models available.

\* All sprinklers are equipped with the selectable pilot valve that allows settings at 50, 65, 80 and 100 psi.



















# INF-FLX35-6

## Performance Series Nozzles

### Performance Data



Nozzle Set (30 to 33)	Nozzle Set 30		Nozzle Set 31		Nozzle Set 32		Nozzle Set 33	
Color								
Color	(White)		(Yellow)		(Blue)		(Brown)	
Part #	102-2208		102-0725		102-0726		102-0727	
Stator #	102-6929 Blue		102-1939 White					
Front								
Color	(Blue)	(Gray)	(Black)	(Green)	(Black)	(Dark Red)	(Black)	(Dark Red)
Part #	102-2925	102-2910	102-6941	118-6697	102-6941	118-6698	102-6941	118-6698
Back Nozzle Positions								
Color	(Red)		(Red)		(Red)		(Red)	
Part #	102-4335		102-4335		102-4335		102-4335	
<b>Part Circle TruJectory 35-6</b>								
Pressure (PSI)	Radius (FT)	Flow (GPM)	Radius (FT)	Flow (GPM)	Radius (FT)	Flow (GPM)	Radius (FT)	Flow (GPM)
50	42	7.6	53	13.9	58	19.4		
65	45	8.3	55	15.9	60	22.3	65	24.3
80	46	9.2	59	17.6	64	24.5	69	26.8
100	48	10.1	61	19.5	68	27.3	73	30.0

### INF-FLX35-6 Nozzle Apex

Pressure	Nozzle	Apex at 15°	Apex at 25°
65 psi	31	6' @ 51'	13' @ 54'
	32	6' @ 51'	11' @ 64'
	33	7' @ 59'	13' @ 68'
	34	8' @ 63'	15' @ 74'
	35	9' @ 66'	15' @ 76'
80 psi	36	8' @ 75'	18' @ 83'
	37	9' @ 74'	19' @ 82'

### Nozzle Angle Installation Key

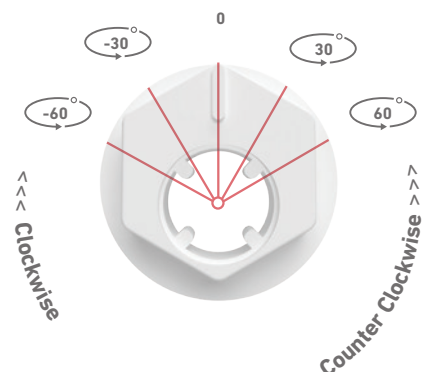















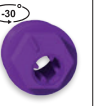

# INF-FLX35-6

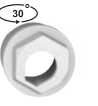
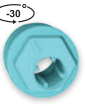
## Performance Series Nozzles



<b>Nozzle Set (34 to 37)</b>	<b>Nozzle Set 34</b>		<b>Nozzle Set 35</b>		<b>Nozzle Set 36</b>		<b>Nozzle Set 37</b>	
<b>Color</b>	 (Orange)		 (Green)		 (Gray)		 (Black)	
<b>Part #</b>	102-7002		102-0729		102-0730		102-4261	
<b>Stator #</b>	102-1939 White		118-7282 Red, Pink					
<b>Front</b>	 30°	 -30°		 -30°		 -30°	 30°	 -30°
<b>Color</b>	(Black)	(Dark Red)	(White)	(Purple)	(White)	(Lt. Blue)	(White)	(Lt. Blue)
<b>Part #</b>	102-6941	118-6698	102-6940	118-6699	102-6940	118-6700	102-6940	118-6700
<b>Back Nozzle Positions</b>								
<b>Color</b>	(Red)		(Red)		(Red)		(Red)	
<b>Part #</b>	102-4335		102-4335		102-4335		102-4335	
<b>Part Circle TruJectory 35-6</b>								
<b>Pressure (PSI)</b>	<b>Radius (FT)</b>	<b>Flow (GPM)</b>	<b>Radius (FT)</b>	<b>Flow (GPM)</b>	<b>Radius (FT)</b>	<b>Flow (GPM)</b>	<b>Radius (FT)</b>	<b>Flow (GPM)</b>
50								
65	70	26.2	75	34.6				
80	73	28.6	79	38.6	80	41.5	85	43.8
100	76	32.0	84	43.1	85	46.5	90	49.3

**Not recommended at these pressures.** Radius shown in feet. Toro® recommends the use of a 1¼" swing joint at flows over 25-gpm (95-LPM). Sprinkler radius data collected in Toro's zero wind test facility per ASAE standard S398.1. Actual site conditions must be considered when selecting the appropriate nozzle. All sprinklers are equipped with the selectable pilot valve that allows settings at 50, 65, 80 and 100 psi.



### Main Nozzle Adapter (118-1521)

A wide assortment of intermediate and inner nozzles for use in the main nozzle adapter and back nozzle position provide unmatched nozzle flexibility.



















# INF-FLX55-6

## Performance Series Nozzles

### Performance Data



<b>Nozzle Set (51 to 54)</b>	<b>Nozzle Set 51</b>		<b>Nozzle Set 52</b>		<b>Nozzle Set 53</b>		<b>Nozzle Set 54</b>	
<b>Color</b>	 (Yellow)		 (Blue)		 (Brown)		 (Orange)	
<b>Part #</b>	102-0725		102-0726		102-0727		102-7002	
<b>Stator #</b>	102-1939 White							
<b>Front</b>								
<b>Color</b>	(Black)	(Green)	(Black)	(Dark Red)	(Black)	(Dark Red)	(Black)	(Purple)
<b>Part #</b>	102-6941	118-6697	102-6941	118-6698	102-6941	118-6698	102-6941	118-6699
<b>Back Nozzle Positions</b>								
<b>Color</b>	(Red)		(Red)		(Red)		(Red)	
<b>Part #</b>	102-4335		102-4335		102-4335		102-4335	
<b>Part Circle TruJectory 55-6</b>								
<b>Pressure (PSI)</b>	<b>Radius (FT)</b>	<b>Flow (GPM)</b>	<b>Radius (FT)</b>	<b>Flow (GPM)</b>	<b>Radius (FT)</b>	<b>Flow (GPM)</b>	<b>Radius (FT)</b>	<b>Flow (GPM)</b>
50	53	14.5	58	19.9				
65	55	16.5	60	22.9	65	25.4	70	26.9
80	59	18.2	65	25	70	27.6	73	30.4
100	61	20.3	70	28	74	30.7	76	33.9

### INF-FLX55-6 Nozzle Apex

Pressure	Nozzle	Apex at 15°	Apex at 25°
65 psi	51	6' @ 51'	13' @ 54'
	52	6' @ 51'	11' @ 64'
	53	7' @ 59'	13' @ 68'
	54	8' @ 63'	15' @ 74'
	55	9' @ 66'	15' @ 76'
80 psi	56	8' @ 75'	18' @ 83'
	57	9' @ 74'	19' @ 82'
	58	10' @ 82'	18' @ 87'
	59	11' @ 81'	21' @ 91'

### Nozzle Angle Installation Key

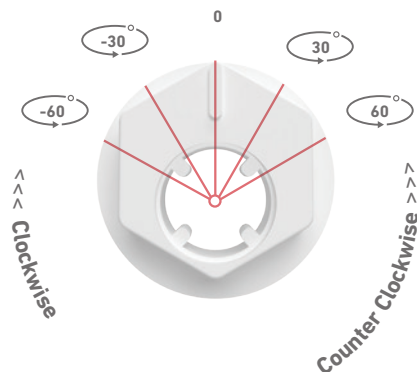





















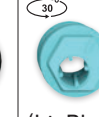

# INF-FLX55-6

## Performance Series Nozzles



<b>Nozzle Set (55 to 59)</b>	<b>Nozzle Set 55</b>		<b>Nozzle Set 56</b>		<b>Nozzle Set 57</b>		<b>Nozzle Set 58</b>		<b>Nozzle Set 59</b>	
<b>Color</b>	 (Green)		 (Gray)		 (Black)		 (Red)		 (Beige)	
<b>Part #</b>	102-0729		102-0730		102-4261		102-4260		102-4259	
<b>Stator #</b>	102-1940 Red, Black (Circles)								102-1941 Red, Black (Spokes)	
<b>Front</b>	 (White)	 (Purple)	 (White)	 (Purple)	 (White)	 (Purple)	 (Black)	 (Lt. Blue)	 (Black)	 (Red)
<b>Part #</b>	102-6940	118-6699	102-6940	118-6699	102-6940	118-6699	102-6941	118-6700	102-6941	102-6944
<b>Back Nozzle Positions</b>										
<b>Color</b>	(Red)		(Red)		(Red)		(Red)		(Red)	
<b>Part #</b>	102-4335		102-4335		102-4335		102-4335		102-4335	
<b>Part Circle Trujectory 55-6</b>										
<b>Pressure (PSI)</b>	<b>Radius (FT)</b>	<b>Flow (GPM)</b>	<b>Radius (FT)</b>	<b>Flow (GPM)</b>	<b>Radius (FT)</b>	<b>Flow (GPM)</b>	<b>Radius (FT)</b>	<b>Flow (GPM)</b>	<b>Radius (FT)</b>	<b>Flow (GPM)</b>
50										
65	75	35.1								
80	80	39.3	80	40.7	85	43.2	88	51.0	95	60.1
100	85	43.9	88	46.1	90	49.8	90	56.3	100	66.3

**Not recommended at these pressures.** Radius shown in feet. Toro® recommends the use of a 1¼" swing joint at flows over 25-gpm (95-LPM). Sprinkler radius data collected in Toro's zero wind test facility per ASAE standard S398.1. Actual site conditions must be considered when selecting the appropriate nozzle. All sprinklers are equipped with the selectable pilot valve that allows settings at 50, 65, 80 and 100 psi.



### Main Nozzle Adapter (118-1521)

A wide assortment of intermediate and inner nozzles for use in the main nozzle adapter and back nozzle position provide unmatched nozzle flexibility.



# FLEX800™ 35-6/55-6 Series Golf Sprinklers

## Specifications

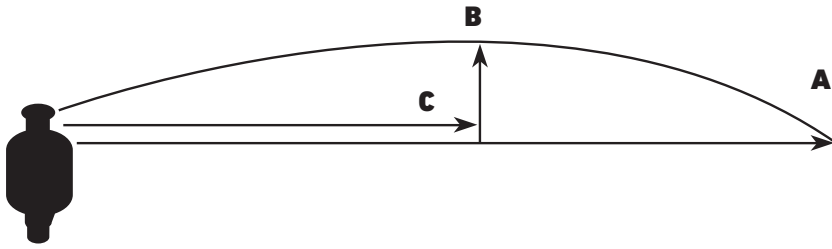

### FLEX800 35-6 Trajectory Performance

Nozzle/psi	#31 Nozzle @ 65 psi						#32 Nozzle @ 65 psi						#33 Nozzle @ 65 psi					
Trajectory	7°	10°	15°	20°	25°	30°	7°	10°	15°	20°	25°	30°	7°	10°	15°	20°	25°	30°
"A" Radius	46'	46'	50'	53'	54'	50'	46'	49'	51'	55'	63'	54'	54'	56'	59'	62'	66'	61'
"B" Spray Height	4'	4'	5'	8'	11'	13'	3'	4'	6'	9'	12'	15'	4'	5'	7'	9'	13'	15'
"C" Distance from Head	25'	25'	26'	33'	33'	33'	20'	24'	28'	34'	34'	34'	23'	28'	32'	34'	35'	35'

Nozzle/psi	#34 Nozzle @ 65 psi						#35 Nozzle @ 65 psi						#36 Nozzle @ 80 psi					
Trajectory	7°	10°	15°	20°	25°	30°	7°	10°	15°	20°	25°	30°	7°	10°	15°	20°	25°	30°
"A" Radius	58'	60'	63'	67'	74'	70'	59'	61'	64'	70'	76'	74'	64'	68'	76'	80'	84'	82'
"B" Spray Height	4'	4'	6'	11'	14'	17'	4'	5'	7'	11'	15'	17'	5'	7'	9'	14'	17'	22'
"C" Distance from Head	24'	26'	35'	39'	39'	39'	30'	32'	36'	43'	43'	43'	25'	38'	40'	45'	49'	45'

Nozzle/psi	#37 Nozzle @ 80 psi					
Trajectory	7°	10°	15°	20°	25°	30°
"A" Radius	65'	69'	78'	82'	86'	84'
"B" Spray Height	5'	7'	9'	14'	18'	22'
"C" Distance from Head	30'	39'	41'	46'	50'	46'

### FLEX800 55-6 Trajectory Performance

Nozzle/psi	#51 Nozzle @ 65 psi						#52 Nozzle @ 65 psi						#53 Nozzle @ 65 psi					
Trajectory	7°	10°	15°	20°	25°	30°	7°	10°	15°	20°	25°	30°	7°	10°	15°	20°	25°	30°
"A" Radius	46'	46'	51'	53'	54'	50'	49'	50'	51'	55'	64'	65'	54'	56'	59'	62'	68'	61'
"B" Spray Height	4'	4'	6'	10'	13'	15'	4'	4'	6'	9'	11'	13'	5'	6'	7'	9'	13'	15'
"C" Distance from Head	26'	27'	32'	38'	40'	41'	22'	26'	31'	35'	34'	30'	30'	33'	32'	35'	37'	37'

Nozzle/psi	#54 Nozzle @ 65 psi						#55 Nozzle @ 65 psi						#56 Nozzle @ 80 psi					
Trajectory	7°	10°	15°	20°	25°	30°	7°	10°	15°	20°	25°	30°	7°	10°	15°	20°	25°	30°
"A" Radius	58'	60'	63'	67'	74'	70'	59'	62'	66'	70'	76'	77'	72'	73'	75'	82'	85'	82'
"B" Spray Height	5'	6'	8'	10'	15'	17'	6'	6'	9'	11'	15'	17'	5'	7'	9'	14'	17'	22'
"C" Distance from Head	31'	34'	40'	41'	41'	42'	34'	36'	43'	45'	45'	45'	25'	38'	40'	45'	49'	45'

Nozzle/psi	#57 Nozzle @ 80 psi						#58 Nozzle @ 80 psi						#59 Nozzle @ 80 psi					
Trajectory	7°	10°	15°	20°	25°	30°	7°	10°	15°	20°	25°	30°	7°	10°	15°	20°	25°	30°
"A" Radius	72'	74'	77'	83'	89'	85'	75'	77'	83'	87'	92'	88'	77'	78'	84'	89'	96'	92'
"B" Spray Height	5'	7'	9'	14'	18'	22'	6'	7'	10'	15'	18'	22'	7'	8'	11'	16'	21'	25'
"C" Distance from Head	30'	39'	41'	46'	50'	46'	38'	40'	43'	47'	52'	48'	42'	44'	45'	47'	53'	49'

Information is for reference only. Actual results may vary.









# FLEX800™ 35/55

## Series Golf Sprinklers

### Specifications

#### Operational

- **Inlet:**
  - FLX35: 1" ACME
  - FLX55: 1½" ACME
- **Radius:**
  - FLX35: 43' – 83'
  - FLX55: 55' – 92'
- **Flow Rate:**
  - FLX35: 8.2 – 47.3 gpm
  - FLX55: 14.1 – 61.3 gpm
- **Precipitation Rates:**
  - FLX35: Minimum - .41"/hr; Maximum - .45"/hr
  - FLX55: Minimum - .46"/hr; Maximum - .58"/hr
- **Pilot Valve:** Selectable at 50, 65, 80 and 100 psi
- **Recommended Operating Pressure Range:** 65-100 psi (maximum -150 psi and minimum - 40 psi)
- **Activation types – Electric Valve-in-Head:**
  - **Standard Solenoid:**
    - 24 VAC, 50/60 Hz
    - Inrush: 0.30 A
    - Holding 0.20 A
  - **Spike Guard Solenoid:**
    - 24 VAC, 50/60 Hz
    - Inrush: 0.12 A
    - Holding 0.10 A
  - **Nickel-Plated Spike Guard™ Solenoid:**
    - 24 VAC, 50/60 Hz
    - Inrush: 0.12 A
    - Holding 0.10 A
  - **DC Latching Solenoid (DCLS):**
    - Momentary low voltage pulse
  - **Integrated Lynx® Smart Module with DCLS:**
    - Momentary low voltage pulse
- **Trajectory:** 24 positions from 7° - 30° in 1° increments

#### Additional Features

- **FLX35 has eight nozzle variations** (30, 31, 32, 33, 34, 35, 36 and 37)
- **FLX55 has nine nozzle variations** (51, 52, 53, 54, 55, 56, 57, 58 and 59)
- Three in-line nozzles, rotating stream pattern
- Two back nozzle position
- Stator variations: 3
- Ratcheting riser
- Nozzle base clutching
- Optional radius reduction screw 363-4839 available for fine tuning

#### FLX35 Conversion Upgrade

MODELS	DESCRIPTION
• FLX35-3134	FLX35 w/31–34 Nozzles (#3 Nozzle Installed)
• FLX35-3537	FLX35 w/35–37 Nozzles (#5 Nozzle Installed)
• FLX35-3134E	FLX35 w/31–34 Nozzles (#3 Nozzle Installed), Effluent
• FLX35-3537E	FLX35 w/35–37 Nozzles (#5 Nozzle Installed), Effluent



#### FLX55 Conversion Upgrades — Ribbed Body

MODELS	DESCRIPTION
• FLX55-5154	FLX55 w/51–54 Nozzles (#3 Nozzle Installed)
• FLX55-5558	FLX55 w/55–58 Nozzles (#5 Nozzle Installed)
• FLX55-59	FLX55 w/59 Nozzle
• FLX55-5154E	FLX55 w/51–54 Nozzles (#3 Nozzle Installed), Effluent
• FLX55-5558E	FLX55 w/55–58 Nozzles (#5 Nozzle Installed), Effluent
• FLX55-59E	FLX55 w/59 Nozzle, Effluent
• 102-5011	690 Adapter allows you to upgrade any 690 with FLX55 conversions
• 102-0950	Required to upgrade all 650, 670, 680, 750, and 780 Series Sprinklers





# FLEX800™ 35/55 Series Golf Sprinklers

## Warranty

- Three years
- Five years when installed with Toro Swing Joints

## Dimensions

- **Body Flange Diameter:**
  - FLX35: 6½"
  - FLX55: 7½"
- **Body height:**
  - FLX35: 10"
  - FLX55: 11¾"
- **Weight:**
  - FLX35: 2.89 lbs.
  - FLX55: 3.57 lbs.
- **Weight Integrated Lynx Smart Module**
  - FLX35: 3.58 lbs.
  - FLX55: 4.26 lbs.
- **Pop-up height to nozzle: 3¼"**

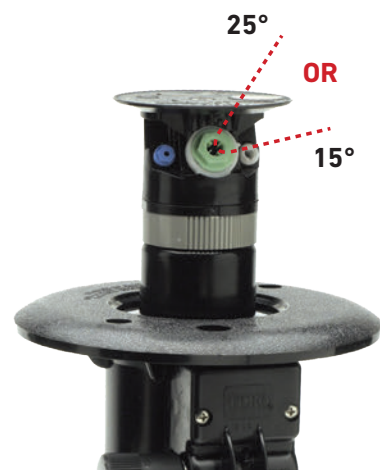

## Dual Trajectory

The 25° setting provides maximum distance of throw and the 15° setting provides improved wind performance, radius reduction and obstacle avoidance.

## FLX55 Conversion Upgrades — Ribless Body

MODELS	DESCRIPTION
• FLX55-5154R	FLX55 w/51-54 Nozzles (#3 Nozzle Installed)
• FLX55-5558R	FLX55 w/55-58 Nozzles (#5 Nozzle Installed)
• FLX55-59R	FLX55 w/59 Nozzle
• FLX55-5154RE	FLX55 w/51-54 Nozzles (#3 Nozzle Installed), Effluent
• FLX55-5558RE	FLX55 w/55-58 Nozzles (#5 Nozzle Installed), Effluent
• FLX55-59RE	FLX55 w/59 Nozzle, Effluent



## Specifying Information — FLEX800 35/55

FLXX5-XXX-X-X					
Body Inlet	Arc	Nozzle	Pressure Regulation*	Activation Type	Optional
<b>FLXX</b>	<b>5</b>	<b>XX</b>	<b>X</b>	<b>X</b>	<b>X</b>
3—1" 5—1½"	5—Part-circle and Full-circle In One	<b>FLX35</b> —30, 31, 32, 33, 34, 35, 36, 37 <b>FLX55</b> —51, 52, 53, 54, 55, 56, 57, 58, 59	6—65 psi 8—80 psi 1—100 psi	1—Standard Solenoid 2—Spike Guard™ Solenoid 3—Nickel-plated Spike Guard Solenoid 4—DC Latching Solenoid (DCLS) 6—Integrated Lynx® Smart Module with DCLS	7—Effluent
<b>Example:</b> When specifying an FLX35-6 Series Sprinkler with #34 nozzle, pressure regulation at 65 psi and Spike Guard you would specify: <b>FLX35-346-2</b>					

Note: Not all models available.

\* All sprinklers are equipped with the selectable pilot valve that allows settings at 50, 65, 80 and 100 psi.























# INF-FLX35

## Performance Series Nozzles

### Performance Data



<b>Nozzle Set (30 to 33)</b>	<b>Nozzle Set 30</b>		<b>Nozzle Set 31</b>		<b>Nozzle Set 32</b>		<b>Nozzle Set 33</b>	
<b>Color</b>	 (White)		 (Yellow)		 (Blue)		 (Brown)	
<b>Part #</b>	102-2208		102-0725		102-0726		102-0727	
<b>Stator #</b>	102-6929 Blue		102-1939 White					
<b>Front</b>								
<b>Color</b>	(Yellow)	(Beige)	(Green)	(Blue)	(Green)	(Blue)	(Green)	(Blue)
<b>Part #</b>	102-5670	102-6942	102-6531	102-2925	102-6531	102-6947	102-6531	102-6947
<b>Back Nozzle Positions</b>								
<b>Color</b>	(Red)	(Red)	(Red)	(Red)	(Red)	(Red)	(Red)	(Red)
<b>Part #</b>	102-4335	102-4335	102-4335	102-4335	102-4335	102-4335	102-4335	102-4335
<b>Part Circle Dual Trajectory 35</b>								
<b>Pressure (PSI)</b>	<b>Radius (FT)</b>	<b>Flow (GPM)</b>	<b>Radius (FT)</b>	<b>Flow (GPM)</b>	<b>Radius (FT)</b>	<b>Flow (GPM)</b>	<b>Radius (FT)</b>	<b>Flow (GPM)</b>
50	43	8.2	52	13.8	57	17.9		
65	45	10.0	55	15.9	60	20.4	65	22.6
80	46	11.5	57	17.6	63	22.7	67	24.9
100	47	13.4	58	19.6	67	25.2	70	27.8

### INF-FLX35 Nozzle Apex

Pressure	Nozzle	Apex at 15°	Apex at 25°
65 psi	31	6' @ 51'	13' @ 54'
	32	6' @ 51'	11' @ 64'
	33	7' @ 59'	13' @ 68'
	34	8' @ 63'	15' @ 74'
	35	9' @ 66'	15' @ 76'
80 psi	36	8' @ 75'	18' @ 83'
	37	9' @ 74'	19' @ 82'

### Nozzle Angle Installation Key

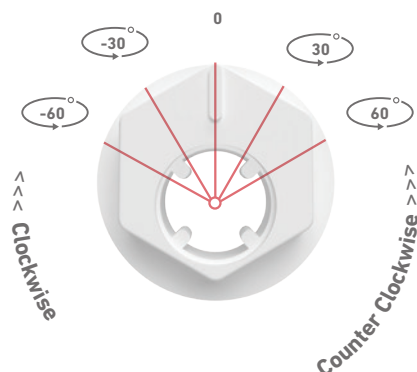























# INF-FLX35

## Performance Series Nozzles



Nozzle Set (34 to 37)	Nozzle Set 34		Nozzle Set 35		Nozzle Set 36		Nozzle Set 37	
<b>Color</b>	 (Orange)		 (Green)		 (Gray)		 (Black)	
<b>Part #</b>	102-7002		102-0729		102-0730		102-4261	
<b>Stator #</b>	102-1939 White		118-7282 Red, Pink					
<b>Front</b>		 <sup>-30°</sup>	 <sup>60°</sup>					
<b>Color</b>	(Yellow)	(Purple)	(White)	(Yellow)	(White)	(Yellow)	(White)	(Yellow)
<b>Part #</b>	102-5670	118-6699	102-6940	102-6946	102-6940	102-6946	102-6940	102-6946
<b>Back Nozzle Positions</b>								
<b>Color</b>	(Red)	(Red)	(Red)	(Red)	(Red)	(Red)	(Red)	(Red)
<b>Part #</b>	102-4335	102-4335	102-4335	102-4335	102-4335	102-4335	102-4335	102-4335
<b>Part Circle Dual Trajectory 35</b>								
Pressure (PSI)	Radius (FT)	Flow (GPM)	Radius (FT)	Flow (GPM)	Radius (FT)	Flow (GPM)	Radius (FT)	Flow (GPM)
50								
65	70	25.6	75	34.2				
80	71	28.5	78	38	80	39.7	85	42.3
100	72	31.7	83	42.5	84	44.5	86	47.3

**Not recommended at these pressures.** Radius shown in feet. Toro® recommends the use of a 1¼" swing joint at flows over 25-gpm (95-LPM). Sprinkler radius data collected in Toro's zero wind test facility per ASAE standard S398.1. Actual site conditions must be considered when selecting the appropriate nozzle. All sprinklers are equipped with the selectable pilot valve that allows settings at 50, 65, 80 and 100 psi.



### Main Nozzle Adapter (118-1521)

A wide assortment of intermediate and inner nozzles for use in the main nozzle adapter and back nozzle position provide unmatched nozzle flexibility.



















# INF-FLX55

## Performance Series Nozzles

### Performance Data



<b>Nozzle Set (51 to 54)</b>	<b>Nozzle Set 51</b>		<b>Nozzle Set 52</b>		<b>Nozzle Set 53</b>		<b>Nozzle Set 54</b>	
<b>Color</b>	 (Yellow)		 (Blue)		 (Brown)		 (Orange)	
<b>Part #</b>	102-0725		102-0726		102-0727		102-7002	
<b>Stator #</b>	102-1939 White							
<b>Front</b>								
<b>Color</b>	(Yellow)	(Brown)	(Green)	(Blue)	(Green)	(Blue)	(Yellow)	(Yellow)
<b>Part #</b>	102-5670	102-5671	102-6531	102-6947	102-6531	102-6947	102-5670	102-6884
<b>Back Nozzle Positions</b>								
<b>Color</b>	(Red)	(Red)	(Red)	(Red)	(Red)	(Red)	(Red)	(Red)
<b>Part #</b>	102-4335	102-4335	102-4335	102-4335	102-4335	102-4335	102-4335	102-4335
<b>Part Circle Dual Trajectory 55</b>								
<b>Pressure (PSI)</b>	<b>Radius (FT)</b>	<b>Flow (GPM)</b>	<b>Radius (FT)</b>	<b>Flow (GPM)</b>	<b>Radius (FT)</b>	<b>Flow (GPM)</b>	<b>Radius (FT)</b>	<b>Flow (GPM)</b>
50	53	13.9	58	18.1				
65	55	15.3	60	20.7	65	22.9	70	25.9
80	57	17.8	64	23.1	68	25.4	71	29.0
100	59	19.8	68	25.8	72	28.6	73	32.4

### INF-FLX55 Nozzle Apex

Pressure	Nozzle	Apex at 15°	Apex at 25°
65 psi	51	6' @ 51'	13' @ 54'
	52	6' @ 51'	11' @ 64'
	53	7' @ 59'	13' @ 68'
	54	8' @ 63'	15' @ 74'
	55	9' @ 66'	15' @ 76'
80 psi	56	8' @ 75'	18' @ 83'
	57	9' @ 74'	19' @ 82'
	58	10' @ 82'	18' @ 87'
	59	11' @ 81'	21' @ 91'

### Nozzle Angle Installation Key

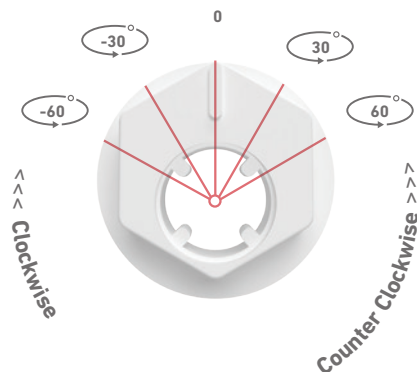



















# INF-FLX55

## Performance Series Nozzles

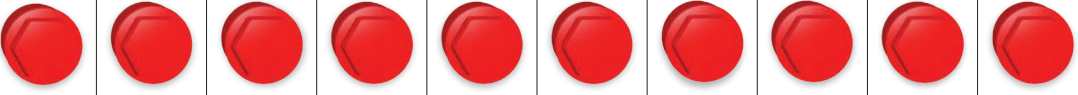

<b>Nozzle Set (55 to 59)</b>	<b>Nozzle Set 55</b>		<b>Nozzle Set 56</b>		<b>Nozzle Set 57</b>		<b>Nozzle Set 58</b>		<b>Nozzle Set 59</b>	
<b>Color</b>	 (Green)		 (Gray)		 (Black)		 (Red)		 (Beige)	
<b>Part #</b>	102-0729		102-0730		102-4261		102-4260		102-4259	
<b>Stator #</b>	118-7282 Red, Pink								102-1941 Red, Black (Spokes)	
<b>Front</b>	 (White)	 (Yellow)	 (White)	 (Yellow)	 (White)	 (Yellow)	 (White)	 (Yellow)	 (White)	 (Yellow)
<b>Part #</b>	102-6940	102-6946	102-6940	102-6946	102-6940	102-6946	102-6940	102-6946	102-6940	102-6946
<b>Back Nozzle Positions</b>										
<b>Color</b>	(Red)									
<b>Part #</b>	102-4335	102-4335	102-4335	102-4335	102-4335	102-4335	102-4335	102-4335	102-4335	102-4335
<b>Part Circle Dual Trajectory 55</b>										
<b>Pressure (PSI)</b>	<b>Radius (FT)</b>	<b>Flow (GPM)</b>	<b>Radius (FT)</b>	<b>Flow (GPM)</b>	<b>Radius (FT)</b>	<b>Flow (GPM)</b>	<b>Radius (FT)</b>	<b>Flow (GPM)</b>	<b>Radius (FT)</b>	<b>Flow (GPM)</b>
50	Not recommended at these pressures.									
65	75	34.6	Not recommended at these pressures.							
80	79	38.5	80	40.0	83	42.9	85	49.0	89	58.1
100	83	43.0	85	45.1	87	48.1	88	54.8	95	64.6

**Not recommended at these pressures.** Radius shown in feet. Toro® recommends the use of a 1 1/4" swing joint at flows over 25-gpm (95-LPM). Sprinkler radius data collected in Toro's zero wind test facility per ASAE standard S398.1. Actual site conditions must be considered when selecting the appropriate nozzle. All sprinklers are equipped with the selectable pilot valve that allows settings at 50, 65, 80 and 100 psi.



### Main Nozzle Adapter (118-1521)

A wide assortment of intermediate and inner nozzles for use in the main nozzle adapter and back nozzle position provide unmatched nozzle flexibility.



# FLEX800™ 34/54

## Series Golf Sprinklers

### Specifications

#### Operational

- **Inlet:**
  - FLX34: 1" ACME
  - FLX54: 1½" ACME
- **Radius:**
  - FLX34: 52' – 91'
  - FLX54: 52' – 99'
- **Flow Rate:**
  - FLX34: 13.0 – 46.9 gpm
  - FLX54: 13.2 – 61.8 gpm
- **Precipitation Rates:**
  - FLX34: Minimum - .33"/hr; Maximum - .55"/hr
  - FLX54: Minimum - .33"/hr; Maximum - .61"/hr
- **Pilot Valve:** Selectable at 50, 65, 80 and 100 psi
- **Recommended Operating Pressure Range:** 65-100 psi (maximum -150 psi and minimum - 40 psi)
- **Activation types – Electric Valve-in-Head:**
  - **Standard Solenoid:**
    - 24 VAC, 50/60 Hz
    - Inrush: 0.30 A
    - Holding 0.20 A
  - **Spike Guard™ Solenoid:**
    - 24 VAC, 50/60 Hz
    - Inrush: 0.12 A
    - Holding 0.10 A
  - **Nickel-Plated Spike Guard Solenoid:**
    - 24 VAC, 50/60 Hz
    - Inrush: 0.12 A
    - Holding 0.10 A
  - **DC Latching Solenoid (DCLS):**
    - Momentary low voltage pulse
  - **Integrated Lynx® Smart Module with DCLS:**
    - Momentary low voltage pulse
- **Trajectory:** 25° or 15°

#### Warranty

- Three years
- Five years when installed with Toro® Swing Joints

#### Dimensions

- **Body Flange Diameter:**
  - FLX34: 6 ½"
  - FLX54: 7 ½"
- **Body height:**
  - FLX34: 10"
  - FLX54: 11 ⅜"
- **Weight:**
  - FLX34: 2.87 lbs.
  - FLX54: 3.55 lbs.
- **Weight Integrated Lynx Smart Module**
  - FLX34: 3.56 lbs.
  - FLX54: 4.24 lbs.
- **Pop-up height to nozzle:** 3¼"

#### FLX34 CONVERSION UPGRADES

MODELS	DESCRIPTION
• FLX34-3134	FLX34 w/31-34 Nozzles (#3 Nozzle Installed)
• FLX34-3537	FLX34 w/35-37 Nozzles (#5 Nozzle Installed)
• FLX34-3134E	FLX34 w/31-34 Nozzles (#3 Nozzle Installed), Effluent
• FLX34-3537E	FLX34 w/35-37 Nozzles (#5 Nozzle Installed), Effluent



#### FLX54 CONVERSION UPGRADES

MODELS	DESCRIPTION
• FLX54-5154	FLX54 w/51-54 Nozzles (#3 Nozzle Installed)
• FLX54-5558	FLX54 w/55-58 Nozzles (#5 Nozzle Installed)
• FLX54-59	FLX54 w/59 Nozzle
• FLX54-5154E	FLX54 w/51-54 Nozzles (#3 Nozzle Installed), Effluent
• FLX54-5558E	FLX54 w/55-58 Nozzles (#5 Nozzle Installed), Effluent
• FLX54-59E	FLX55 w/59 Nozzle, Effluent
• 102-5011	690 Adapter allows you to upgrade any 690 with FLX54 conversions
• 102-0950	Required to upgrade all 1.5" Series Sprinklers (650, 670, 680, 750, and 780)





# FLEX800™ 34/54 Series Golf Sprinklers



## Dual Trajectory

The 25° setting provides maximum distance of throw and the 15° setting provides improved wind performance, radius reduction and obstacle avoidance.

## Specifying Information — FLEX800 34/54

FLXX4-XXX-X-X					
Body Inlet	Arc	Nozzle	Pressure Regulation*	Activation Type	Optional
FLXX	4	XX	X	X	X
3—1" 5—1½"	4—Full-circle	FLX34—30, 31, 32, 33, 34, 35, 36, 37 FLX54—51, 52, 53, 54, 55, 56, 57, 58, 59	6—65 psi 8—80 psi 1—100 psi	1—Standard Solenoid 2—Spike Guard™ Solenoid 3—Nickel-plated Spike Guard Solenoid 4—DC Latching Solenoid (DCLS) 6—Integrated Lynx® Smart Module with DCLS	7—Effluent
<b>Example:</b> When specifying an FLX34 Series Sprinkler with #34 nozzle, pressure regulation at 65 psi and Spike Guard you would specify: <b>FLX34-346-2</b>					

Note: Not all models available.

\* All sprinklers are equipped with the selectable pilot valve that allows settings at 50, 65, 80 and 100 psi.



# INF-FLX34

## Performance Series Nozzles

### Performance Data



Nozzle Set (31 to 34)	Nozzle Set 31		Nozzle Set 32		Nozzle Set 33		Nozzle Set 34	
<b>Color</b>	(Yellow)		(Blue)		(Brown)		(Orange)	
<b>Part #</b>	102-0725		102-0726		102-0727		102-7002	
<b>Stator #</b>	102-6929 Blue							
<b>Front</b>								
<b>Color</b>	(Orange)	(Red)	(Red)	(Red)	(Red)	(Red)	(Red)	(Red)
<b>Part #</b>	102-2926	102-4335	102-4335	102-4335	102-4335	102-4335	102-4335	102-4335
<b>Back Nozzle Positions</b>								
<b>Color</b>	(White)	(Red)	(Yellow)	(Orange)	(Yellow)	(Red)	(Yellow)	(Beige)
<b>Part #</b>	102-6940	102-4335	102-6937	102-2926	102-6937	102-2928	102-6937	102-2929
<b>Full Circle Dual Trajectory 34</b>								
<b>Pressure (PSI)</b>	<b>Radius (FT)</b>	<b>Flow (GPM)</b>	<b>Radius (FT)</b>	<b>Flow (GPM)</b>	<b>Radius (FT)</b>	<b>Flow (GPM)</b>	<b>Radius (FT)</b>	<b>Flow (GPM)</b>
50	54	15.5	58	18.5				
65	55	18.0	60	21.1	65	25.4	70	28.9
80	59	19.9	67	23.6	71	28.5	75	32.4
100	61	22.2	70	26.5	76	32.0	79	36.0

### INF-FLX34 Nozzle Apex

Pressure	Nozzle	Apex at 15°	Apex at 25°
65 psi	31	6' @ 51'	13' @ 54'
	32	6' @ 51'	11' @ 64'
	33	7' @ 59'	13' @ 68'
	34	8' @ 63'	15' @ 74'
	35	9' @ 66'	15' @ 76'
80 psi	36	8' @ 75'	18' @ 83'
	37	9' @ 74'	19' @ 82'

### Nozzle Angle Installation Key

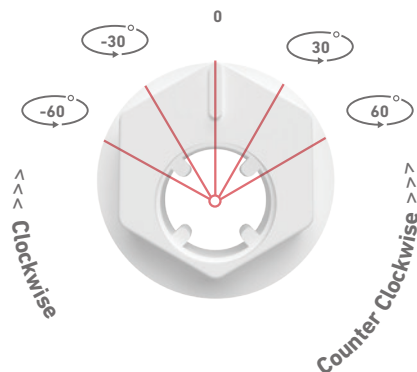

















# INF-FLX34

## Performance Series Nozzles



Nozzle Set (35 to 37)	Nozzle Set 35		Nozzle Set 36		Nozzle Set 37	
						
<b>Color</b>	(Green)		(Gray)		(Black)	
<b>Part #</b>	102-0729		102-0730		102-4261	
<b>Stator #</b>	102-1940 Red, Black (Circles)					
<b>Front</b>						
	(Red)	(Red)	(Brown)	(Red)	(Red)	(Lt. Blue)
<b>Part #</b>	102-4335	102-4335	102-6883	102-4335	102-4335	118-6700
<b>Back Nozzle Positions</b>						
<b>Color</b>	(Yellow)	(Beige)	(White)	(Beige)	(White)	(Beige)
<b>Part #</b>	102-6937	102-2929	102-6940	102-6942	102-6940	102-6942
<b>Full Circle Dual Trajectory 34</b>						
<b>Pressure (PSI)</b>	<b>Radius (FT)</b>	<b>Flow (GPM)</b>	<b>Radius (FT)</b>	<b>Flow (GPM)</b>	<b>Radius (FT)</b>	<b>Flow (GPM)</b>
50						
65	75	37.4				
80	82	41.3	80	46.8	85	52.3
100	86	46.0	87	52.1	89	58.5

**Not recommended at these pressures.** Radius shown in feet. Toro® recommends the use of a 1¼" swing joint at flows over 25-gpm (95-LPM). Sprinkler radius data collected in Toro's zero wind test facility per ASAE standard S398.1. Actual site conditions must be considered when selecting the appropriate nozzle. All sprinklers are equipped with the selectable pilot valve that allows settings at 50, 65, 80 and 100 psi.



### Main Nozzle Adapter (118-1521)

A wide assortment of intermediate and inner nozzles for use in the main nozzle adapter and back nozzle position provide unmatched nozzle flexibility.





















# INF-FLX54

## Performance Series Nozzles

### Performance Data



Nozzle Set (51 to 54)	Nozzle Set 51		Nozzle Set 52		Nozzle Set 53		Nozzle Set 54	
<b>Color</b>	(Yellow)		(Blue)		(Brown)		(Orange)	
<b>Part #</b>	102-0725		102-0726		102-0727		102-7002	
<b>Stator #</b>	102-1939 White							
<b>Front</b>								
<b>Color</b>	(Orange)	(Red)	(Red)	(Red)	(Red)	(Red)	(Red)	(Red)
<b>Part #</b>	102-2926	102-4335	102-4335	102-4335	102-4335	102-4335	102-4335	102-4335
<b>Back Nozzle Positions</b>								
<b>Color</b>	(White)	(Red)	(Yellow)	(Orange)	(Yellow)	(Red)	(Yellow)	(Beige)
<b>Part #</b>	102-6940	102-4335	102-6937	102-2926	102-6937	102-2928	102-6937	102-2929
<b>Full Circle Dual Trajectory 54</b>								
<b>Pressure (PSI)</b>	<b>Radius (FT)</b>	<b>Flow (GPM)</b>	<b>Radius (FT)</b>	<b>Flow (GPM)</b>	<b>Radius (FT)</b>	<b>Flow (GPM)</b>	<b>Radius (FT)</b>	<b>Flow (GPM)</b>
50	54	15.9	60	18.9				
65	55	18.1	62	21.6	65	25.8	70	29.4
80	58	20.3	68	24.0	70	29.0	75	32.9
100	62	22.7	72	27.0	75	32.5	77	36.5

### INF-FLX54 Nozzle Apex

Pressure	Nozzle	Apex at 15°	Apex at 25°
65 psi	30	6' @ 51'	13' @ 54'
	31	6' @ 51'	11' @ 64'
	32	7' @ 59'	13' @ 68'
	33	8' @ 63'	15' @ 74'
	55	9' @ 66'	15' @ 76'
80 psi	56	8' @ 75'	18' @ 83'
	57	9' @ 74'	19' @ 82'
	58	10' @ 82'	18' @ 87'
	59	11' @ 81'	21' @ 91'

### Nozzle Angle Installation Key

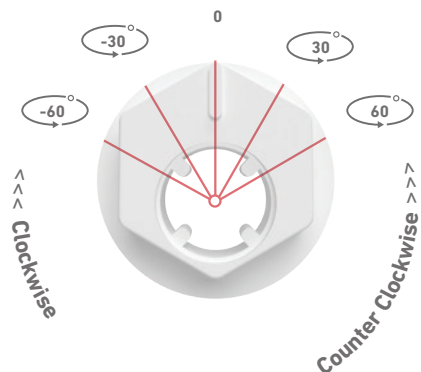



























# INF-FLX54

## Performance Series Nozzles



Nozzle Set (55 to 59)	Nozzle Set 55		Nozzle Set 56		Nozzle Set 57		Nozzle Set 58		Nozzle Set 59	
<b>Color</b>	 (Green)		 (Gray)		 (Black)		 (Red)		 (Beige)	
<b>Part #</b>	102-0729		102-0730		102-4261		102-4260		102-4259	
<b>Stator #</b>	102-1940 Red, Black (Circles)								118-7282 Red, Pink	
<b>Front</b>	 (Brown)	 (Red)	 (Brown)	 (Red)	 (Red)	 (Lt. Blue)	 (White)	 (Red)	 (Red)	 (Red)
<b>Part #</b>	102-6883	102-4335	102-6883	102-4335	102-4335	118-6700	102-6940	102-4335	102-4335	102-6944
<b>Back Nozzle Positions</b>	 (White)	 (Beige)	 (White)	 (Beige)	 (White)	 (Beige)	 (Beige)	 (Gray)	 (White)	 (Red)
<b>Color</b>	(White)	(Beige)	(White)	(Beige)	(White)	(Beige)	(Beige)	(Gray)	(White)	(Red)
<b>Part #</b>	102-6940	102-6942	102-6940	102-6942	102-6940	102-6942	102-6942	102-6945	102-6940	102-4335
<b>Full Circle Dual Trajectory 54</b>										
<b>Pressure (PSI)</b>	<b>Radius (FT)</b>	<b>Flow (GPM)</b>	<b>Radius (FT)</b>	<b>Flow (GPM)</b>	<b>Radius (FT)</b>	<b>Flow (GPM)</b>	<b>Radius (FT)</b>	<b>Flow (GPM)</b>	<b>Radius (FT)</b>	<b>Flow (GPM)</b>
50										
65	75	40.8								
80	79	45.6	80	47.3	85	52.9	85	57.9	97	60.7
100	84	50.9	87	53.0	90	59.1	94	65.4	104	67.4

**Not recommended at these pressures.** Radius shown in feet. Toro® recommends the use of a 1 1/4" swing joint at flows over 25-gpm (95-LPM). Sprinkler radius data collected in Toro's zero wind test facility per ASAE standard S398.1. Actual site conditions must be considered when selecting the appropriate nozzle. All sprinklers are equipped with the selectable pilot valve that allows settings at 50, 65, 80 and 100 psi.

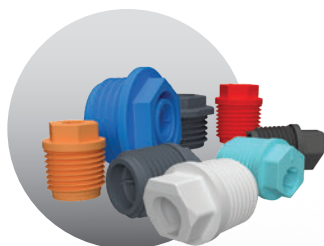

### Main Nozzle Adapter (118-1521)

A wide assortment of intermediate and inner nozzles for use in the main nozzle adapter and back nozzle position provide unmatched nozzle flexibility.



# FLEX800™ 35-6B/34B/35B Series Golf Sprinklers

## Specifications

### Operational

- **Inlet:**
  - 1" NPT, BSP or ACME
- **Radius:**
  - FLX35-6B: 42' – 95'
  - FLX35B: 43' – 90'
  - FLX34B: 57' – 95'
- **Flow Rate:**
  - FLX35-6B : 7.1 – 52.5 gpm
  - FLX35B: 8.2 – 56.3 gpm
  - FLX34B: 13.0 – 55.4 gpm
- **Precipitation Rates:**
  - FLX35-6B: Minimum - .34"/hr; Maximum - .56"/hr
  - FLX35B: Minimum - .37"/hr; Maximum - .67"/hr
  - FLX34B: Minimum - .33"/hr; Maximum - .59"/hr
- **Recommended Operating Pressure Range:** 50-100 psi (maximum – 150 psi and minimum – 40 psi)
- Check-O-Matic models maintain up to 5' elevation change

### Nozzle Variations

- **FLX35-6B - Nine variations** (30, 31, 32, 33, 34, 35, 36, 37 & 38)
- **FLX34B - Nine variations** (30, 31, 32, 33, 34, 35, 36, 37 & 38)
- **FLX54B – Eight variations** (31, 32, 33, 34, 35, 36, 37 & 38)
- **Back nozzle capability on part circle models standard**
  - **FLX35-6B** – one position available
  - **FLX35B** – two positions available
  - **FLX34B** – two additional front nozzle positions
- Main-less capability for short radius applications
- Stator variations - 2
- Radius reduction screw for fine tuning the radius (363-4839)  
Optional on: FLX35B, FLX34B & not available on FLX35-6B models
- Ratcheting riser – Part circle models
- Nozzle base clutching – Part circle models

### Warranty

- Three years
- Five years when installed with Toro® Swing Joints

### Dimensions

- **Body Flange Diameter:** 6"
- **Body height:** 8.5"
- **Weight:**
  - FLX34B – 1.98 lbs.
  - FLX35B – 2.00 lbs.
  - FLX35-6B – 2.05 lbs.
- **Pop-up height to nozzle:** 3¼"



FLX35B



# FLEX800™ 35-6B/34B/35B Series Golf Sprinklers



FLX35-6B

FLX34B & FLX35B

### Nozzle Trajectory Provides Unmatched Performance

**FLX35-6B** with TruJectory™ adjustment from 7°-30° in 1° increments and **FLX35/FLX34** models with dual trajectory settings of 25° or 15° provide improved wind performance, obstacle avoidance and radius adjustment.

### Specifying Information — FLEX800™ B Series

FLX3XB-X2-XXXXX						
Series	Arc	System	Thread Type	Valve Type	Nozzle	Optional
<b>FLX3</b>	<b>X</b>	<b>B</b>	<b>X</b>	<b>2</b>	<b>XXXX</b>	<b>X</b>
FLX3 – FLEX800 B Series	4—Full-Circle 5—Part-/Full-Circle 5-6—Part-/Full-Circle with TruJectory	<b>B</b> —Block	0—NPT 4—ACME 5—BSP	Check-O-Matic	3134— Includes nozzles #31, 32, 33 & 34 3538— Includes nozzles #35, 36, 37 & 38	E—Effluent Model

**Example:** When specifying a FLEX800 B Series Sprinkler with full circle – NPT threads #34 nozzles, you would specify: **FLX34B-02-3134**



# Intermediate Nozzle Performance Charts

102-2929 Beige		Trajectory		30°		25°		20°		15°		10°		7°	
Pressure		Flow		Radius		Radius		Radius		Radius		Radius		Radius	
psi	BAR	gpm	lpm	Feet	Meters	Feet	Meters	Feet	Meters	Feet	Meters	Feet	Meters	Feet	Meters
50	3.4	8.1	30.7	53	17.4	52	17.1	50	16.4	48	15.7	45	14.8	42	13.8
60	4.1	8.9	33.7	57	18.7	56	18.4	53	17.4	51	16.7	47	15.4	45	14.8
65	4.5	9.3	35.2	58	19.0	56	18.4	54	17.7	51	16.7	49	16.1	46	15.1
70	4.8	9.6	36.3	59	19.4	57	18.7	56	18.4	53	17.4	50	16.4	48	15.7
80	5.5	10.3	39.0	61	20.0	60	19.7	58	19.0	56	18.4	53	17.4	50	16.4
90	6.2	10.9	41.3	63	20.7	61	20.0	59	19.4	57	18.7	54	17.7	51	16.7
100	6.9	11.5	43.5	65	21.3	63	20.7	60	19.7	58	19.0	55	18.0	51	16.7

102-2928 Red		Trajectory		30°		25°		20°		15°		10°		7°	
Pressure		Flow		Radius		Radius		Radius		Radius		Radius		Radius	
psi	BAR	gpm	lpm	Feet	Meters	Feet	Meters	Feet	Meters	Feet	Meters	Feet	Meters	Feet	Meters
50	3.4	6.3	23.8	53	17.4	51	16.7	48	15.7	46	15.1	43	14.1	40	13.1
60	4.1	7.0	26.5	55	18.0	53	17.4	50	16.4	48	15.7	45	14.8	42	13.8
65	4.5	7.2	27.3	56	18.4	54	17.7	52	17.1	49	16.1	47	15.4	44	14.4
70	4.8	7.5	28.4	57	18.7	55	18.0	53	17.4	51	16.7	49	16.1	46	15.1
80	5.5	8.0	30.3	59	19.4	58	19.0	56	18.4	54	17.7	52	17.1	49	16.1
90	6.2	8.5	32.2	60	19.7	58	19.0	57	18.7	55	18.0	53	17.4	50	16.4
100	6.9	9.0	34.1	61	20.0	59	19.4	57	18.7	55	18.0	53	17.4	50	16.4

102-2927 Gray		Trajectory		30°		25°		20°		15°		10°		7°	
Pressure		Flow		Radius		Radius		Radius		Radius		Radius		Radius	
psi	BAR	gpm	lpm	Feet	Meters	Feet	Meters	Feet	Meters	Feet	Meters	Feet	Meters	Feet	Meters
50	3.4	5.0	18.9	50	16.4	48	15.7	46	15.1	44	14.4	41	13.5	38	12.5
60	4.1	5.5	20.8	52	17.1	50	16.4	48	15.7	46	15.1	43	14.1	40	13.1
65	4.5	5.7	21.6	53	17.4	51	16.7	49	16.1	46	15.1	44	14.4	41	13.5
70	4.8	5.9	22.3	53	17.4	51	16.7	49	16.1	47	15.4	45	14.8	42	13.8
80	5.5	6.3	23.8	54	17.7	52	17.1	50	16.4	48	15.7	46	15.1	43	14.1
90	6.2	6.7	25.4	55	18.0	53	17.4	52	17.1	50	16.4	48	15.7	45	14.8
100	6.9	7.1	26.9	55	18.0	54	17.7	53	17.4	52	17.1	50	16.4	46	15.1

102-2926 Orange		Trajectory		30°		25°		20°		15°		10°		7°	
Pressure		Flow		Radius		Radius		Radius		Radius		Radius		Radius	
psi	BAR	gpm	lpm	Feet	Meters	Feet	Meters	Feet	Meters	Feet	Meters	Feet	Meters	Feet	Meters
50	3.4	4.3	16.3	48	15.7	46	15.1	44	14.4	42	13.8	39	12.8	35	11.5
60	4.1	4.7	17.8	50	16.4	48	15.7	46	15.1	44	14.4	41	13.5	38	12.5
65	4.5	4.9	18.5	51	16.7	49	16.1	47	15.4	45	14.8	42	13.8	39	12.8
70	4.8	5.1	19.3	51	16.7	50	16.4	48	15.7	46	15.1	43	14.1	40	13.1
80	5.5	5.4	20.4	52	17.1	51	16.7	50	16.4	48	15.7	45	14.8	42	13.8
90	6.2	5.8	22.0	53	17.4	52	17.1	51	16.7	49	16.1	47	15.4	44	14.4
100	6.9	6.1	23.1	54	17.7	53	17.4	52	17.1	50	16.4	48	15.7	45	14.8

102-2925 Blue		Trajectory		30°		25°		20°		15°		10°		7°	
Pressure		Flow		Radius		Radius		Radius		Radius		Radius		Radius	
psi	BAR	gpm	lpm	Feet	Meters	Feet	Meters	Feet	Meters	Feet	Meters	Feet	Meters	Feet	Meters
50	3.4	2.7	10.2	42	13.8	41	13.5	39	12.8	38	12.5	36	11.8	34	11.2
60	4.1	3.0	11.4	43	14.1	42	13.8	40	13.1	39	12.8	37	12.1	35	11.5
65	4.5	3.2	12.1	43	14.1	42	13.8	40	13.1	39	12.8	37	12.1	35	11.5
70	4.8	3.3	12.5	44	14.4	42	13.8	41	13.5	39	12.8	38	12.5	36	11.8
80	5.5	3.5	13.2	44	14.4	43	14.1	41	13.5	40	13.1	38	12.5	36	11.8
90	6.2	3.7	14.0	45	14.8	44	14.4	42	13.8	41	13.5	39	12.8	37	12.1
100	6.9	3.9	14.8	45	14.8	44	14.4	43	14.1	42	13.8	40	13.1	38	12.5





# Intermediate Nozzle Performance Charts

102-6885 Green		Trajectory		30°		25°		20°		15°		10°		7°	
Pressure		Flow		Radius		Radius		Radius		Radius		Radius		Radius	
psi	BAR	gpm	lpm	Feet	Meters	Feet	Meters	Feet	Meters	Feet	Meters	Feet	Meters	Feet	Meters
50	3.4	5.4	20.4	51	16.7	50	16.4	48	15.7	45	14.8	42	13.8	39	12.8
60	4.1	5.9	22.3	52	17.1	51	16.7	49	16.1	46	15.1	43	14.1	41	13.5
65	4.5	6.1	23.1	52	17.1	51	16.7	50	16.4	47	15.4	44	14.4	42	13.8
70	4.8	6.3	23.8	53	17.4	52	17.1	50	16.4	47	15.4	44	14.4	42	13.8
80	5.5	6.7	25.4	53	17.4	52	17.1	51	16.7	48	15.7	45	14.8	43	14.1
90	6.2	7.1	26.9	54	17.7	53	17.4	52	17.1	50	16.4	47	15.4	45	14.8
100	6.9	7.4	28.0	55	18.0	55	18.0	54	17.7	52	17.1	49	16.1	47	15.4

102-6884 Yellow		Trajectory		30°		25°		20°		15°		10°		7°	
Pressure		Flow		Radius		Radius		Radius		Radius		Radius		Radius	
psi	BAR	gpm	lpm	Feet	Meters	Feet	Meters	Feet	Meters	Feet	Meters	Feet	Meters	Feet	Meters
50	3.4	4.1	15.5	48	15.7	47	15.4	45	14.8	41	13.5	38	12.5	35	11.5
60	4.1	4.5	17.0	49	16.1	48	15.7	47	15.4	44	14.4	41	13.5	38	12.5
65	4.5	4.7	17.8	50	16.4	49	16.1	48	15.7	45	14.8	42	13.8	39	12.8
70	4.8	4.8	18.2	50	16.4	49	16.1	48	15.7	45	14.8	43	14.1	40	13.1
80	5.5	5.1	19.3	51	16.7	50	16.4	49	16.1	47	15.4	44	14.4	41	13.5
90	6.2	5.4	20.4	53	17.4	52	17.1	50	16.4	48	15.7	45	14.8	42	13.8
100	6.9	5.8	22.0	54	17.7	53	17.4	51	16.7	49	16.1	46	15.1	43	14.1

102-6883 Brown		Trajectory		30°		25°		20°		15°		10°		7°	
Pressure		Flow		Radius		Radius		Radius		Radius		Radius		Radius	
psi	BAR	gpm	lpm	Feet	Meters	Feet	Meters	Feet	Meters	Feet	Meters	Feet	Meters	Feet	Meters
50	3.4	2.4	9.1	41	13.5	40	13.1	38	12.5	36	11.8	33	10.8	30	9.8
60	4.1	2.6	9.8	43	14.1	42	13.8	40	13.1	38	12.5	36	11.8	33	10.8
65	4.5	2.7	10.2	44	14.4	42	13.8	41	13.5	39	12.8	37	12.1	34	11.2
70	4.8	2.8	10.6	45	14.8	43	14.1	42	13.8	40	13.1	38	12.5	35	11.5
80	5.5	3.0	11.4	46	15.1	45	14.8	43	14.1	41	13.5	40	13.1	36	11.8
90	6.2	3.2	12.1	46	15.1	45	14.8	44	14.4	42	13.8	41	13.5	37	12.1
100	6.9	3.4	12.9	46	15.1	45	14.8	44	14.4	43	14.1	41	13.5	38	12.5

102-6937 Yellow		Trajectory		30°		25°		20°	
Pressure		Flow		Radius		Radius		Radius	
psi	BAR	gpm	lpm	Feet	Meters	Feet	Meters	Feet	Meters
50	3.4	3.7	14.0	26	8.5	24	7.9	20	6.6
60	4.1	4.0	15.1	28	9.2	25	8.2	22	7.2
65	4.5	4.2	15.9	28	9.2	25	8.2	22	7.2
70	4.8	4.4	16.7	28	9.2	26	8.5	23	7.5
80	5.5	4.7	17.8	28	9.2	26	8.5	24	7.9
90	6.2	5.0	18.9	29	9.5	27	8.9	25	8.2
100	6.9	5.2	19.7	30	9.8	29	9.5	27	8.9

102-6531 Green		Trajectory		30°		25°		20°	
Pressure		Flow		Radius		Radius		Radius	
psi	BAR	gpm	lpm	Feet	Meters	Feet	Meters	Feet	Meters
50	3.4	4.0	15.1	32	10.5	30	9.8	26	8.5
60	4.1	4.3	16.3	34	11.2	31	10.2	27	8.9
65	4.5	4.5	17.0	34	11.2	31	10.2	27	8.9
70	4.8	4.7	17.8	34	11.2	31	10.2	28	9.2
80	5.5	5.0	18.9	34	11.2	32	10.5	29	9.5
90	6.2	5.3	20.1	34	11.2	32	10.5	29	9.5
100	6.9	5.6	21.2	35	11.5	33	10.8	30	9.8



Main Nozzle Adaptor  
P/N 118-1521



# Sprinkler Conversion Assemblies

## Specifications



Cross Reference Guide					Models Being Replaced										
New Model	Arc	Trajectory	Radius - Ft	Flow - gpm	634	664	734	764	765	864S	865S	834S	835S	DT34	DT35
FLX34-3134	Full Circle	25° or 15°	52' - 79'	12.9 - 34.9	X	X	X	X	X	X	X	X	X	X	X
FLX34-3537	Full Circle	25° or 15°	67' - 91'	32.1 - 46.9	X	X	X	X	X	X	X	X	X	X	X
FLX35-3134	Part/Full Circle	25° or 15°	52' - 74'	13.6 - 34.1			1	X	X	X	X	X	X	X	X
FLX35-3537	Part/Full Circle	25° or 15°	69' - 83'	33.1 - 47.3			1	X	X	X	X	X	X	X	X
FLX35-6-3134	Part/Full Circle	30° - 7°	46' - 80'	15.5 - 37.0			1	X	X	X	X	X	X	X	X
FLX35-6-3537	Part/Full Circle	30° - 7°	59' - 92'	32.4 - 45.3			1	X	X	X	X	X	X	X	X

1. Must have ribbed bodies manufactured after 1992 to use Part/Full circles.

Cross Reference Guide					Models Being Replaced													
New Model	Arc	Trajectory	Radius - Ft	Flow - gpm	654	655	670	684	690	754	784	785	884S	885S	854S	855S	DT54	DT55
FLX54-5154	Full Circle	25° or 15°	58' - 81'	13.2 - 36.7	2	2	2	2	4	2	2	2	X	X	X	X	X	X
FLX54-5558	Full Circle	25° or 15°	79' - 95'	34.2 - 55.4	2	2	2	2	4	2	2	2	X	X	X	X	X	X
FLX54-59	Full Circle	25° or 15°	96' - 99'	55.6 - 61.8	2	2	2	2	4	2	2	2	X	X	X	X	X	X
FLX55-5154	Part/Full Circle	25° or 15°	55' - 75'	14.0 - 34.5					4	2	2	2	X	X	X	X	X	X
FLX55-5558	Part/Full Circle	25° or 15°	73' - 90'	35.3 - 53.9					4	2	2	2	X	X	X	X	X	X
FLX55-59	Part/Full Circle	25° or 15°	82' - 92'	57.2 - 61.3					4	2	2	2	X	X	X	X	X	X
FLX55-6-5154	Part/Full Circle	30° - 7°	46' - 80'	13.9 - 38.2					4	2	2	2	X	X	X	X	X	X
FLX55-6-5558	Part/Full Circle	30° - 7°	59' - 95'	33.8 - 51.1					4	2	2	2	X	X	X	X	X	X
FLX55-6-59	Part/Full Circle	30° - 7°	77' - 100'	57.0 - 61.1					4	2	2	2	X	X	X	X	X	X
FLX55-5154R	Part/Full Circle	25° or 15°	55' - 75'	14.0 - 34.5	3	3	3	3		3								
FLX55-5558R	Part/Full Circle	25° or 15°	73' - 90'	35.3 - 53.9	3	3	3	3		3								
FLX55-59R	Part/Full Circle	25° or 15°	82' - 92'	57.2 - 61.3	3	3	3	3		3								
FLX55-6-5154R	Part/Full Circle	30° - 7°	46' - 80'	13.9 - 38.2	3	3	3	3		3								
FLX55-6-5558R	Part/Full Circle	30° - 7°	59' - 95'	33.8 - 51.1	3	3	3	3		3								
FLX55-6-59R	Part/Full Circle	30° - 7°	77' - 100'	57.0 - 61.1	3	3	3	3		3								

2 - Requires the separate purchase and use of 102-0950 conversion adapter

3 - Use the "R" Series (Ribless body) conversion for bodies dated prior to 1992.

4 - Requires the separate purchase and use of 102-5011 690 conversion adapter



# FLEX800™ R Series Conversion Upgrades

## Specifications

### Operational

- Ratcheting riser allows riser positioning without riser removal
- Recommended Operating Pressure Range: 60-100 psi (maximum – 150 psi and minimum – 40 psi)
- Radius reduction screw for radius refinement
- Riser pull-up feature simplifies servicing
- Effluent identifier included
- Yardage marker capable
- 3.25" pop-up clears tall grasses

### Nozzles

- 4 main nozzle combinations included provides a wide range of radius and flow capabilities
- Back nozzle capable (FLX55-6RB & FLX55RB)
- Two additional front nozzle positions (FLX54RB only)
- Nozzle base clutching (FLX55-6RB & FLX55RB) allows nozzle base movement by hand
- All nozzles threaded from the front with no other disassembly required

### Adds 1½" of Pop-up Height

**Left:** Rain Bird® Eagle™ 900

**Right:** Rain Bird® Eagle 900 upgraded with Toro® R Series upgrade assembly and optional Spike Guard™ solenoid/adaptor



**20,000 Volt Lightning Rating**

### Specifying Information — FLEX800 R Series Conversion Assemblies

Model Number	Description
FLX55-6RB-5154	R Series Conversion with FLX55-6 riser assembly and low flow nozzle set #51 - #54
FLX55-6RB-5558	R Series Conversion with FLX55-6 riser assembly and high flow nozzle set #55 - #58
FLX55RB-5154	R Series Conversion with FLX55 riser assembly and low flow nozzle set #51 - #54
FLX55RB-5558	R Series Conversion with FLX55 riser assembly and high flow nozzle set #55 - #58
FLX54RB-5154	R Series Conversion with FLX54 riser assembly and low flow nozzle set #51 - #54
FLX54RB-5558	R Series Conversion with FLX54 riser assembly and high flow nozzle set #55 - #58
SPIKEGUARD-RB	Toro solenoid adaptor with Spike Guard™ solenoid for Rain Bird® Eagle 700, 900 or 1100 Series sprinklers





Toro® has designed and manufactured this product to fit within a sprinkler housing made by Rain Bird® Corporation, but Toro's product is not manufactured by or affiliated with Rain Bird®. Rain Bird® is a registered trademark of Rain Bird Corporation. Eagle is a trademark of Rain Bird Corporation.



# Golf Irrigation

## Flex800™ R Series Conversion Upgrades – Mainless Data





### FLX55-6RB Series Mainless Nozzle Performance Data

										
	Blue Plug Gray 102-2925 102-2208 102-2910		Orange Plug Gray 102-2926 102-2208 102-2910		Red Plug Gray 102-2928 102-2208 102-2910		Gray Plug Gray 102-2910 102-2208 102-2910		Gray Plug Gray 102-2930 102-2208 102-2910	
psi	Radius	gpm	Radius	gpm	Radius	gpm	Radius	gpm	Radius	gpm
65	46	8.7	46	10.4	50	12.4	42	10.2	47	13.9
SOR	5:02		4:16		3:36		4:19		4:06	
80	46	9.6	47	11.5	53	13.7	44	11.2	51	15.3
SOR	4:22		3:40		3:03		3:53		3:40	

Requires the low-flow stator 102-6929 for indicated rotation speeds.

SOR: Speed of rotation

### FLX55RB Mainless Nozzle Performance Data

								
	Green Plug Gray 102-6531 102-2208 102-2910		Green Plug Green 102-6531 102-2208 102-6885		Green Plug Red 102-6531 102-2208 102-2928		Green Plug Beige 102-6531 102-2208 102-2929	
psi	Radius	gpm	Radius	gpm	Radius	gpm	Radius	gpm
65	34	10.4	44	10.2	48	11.5	50	13.5
SOR	3:40		3:50		3:25		2:40	
80	37	11.6	44	11.4	48	12.9	50	15.0
SOR	3:15		3:25		3:00		2:30	

Requires the low-flow stator 102-6929 for indicated rotation speeds.

SOR: Speed of rotation

## Flex800 R Series Conversion Upgrades – Back Nozzle Performance Data

Nozzles			65 psi		80 psi		Profile
Part #	Description	Color	Radius	gpm	Radius	gpm	
102-6937	Inner Nozzle w/ Yellow Restrictor	 Yel/Yel	29	3.7	30	4.1	
102-6531	Inner Nozzle w/ White Restrictor	 Grn/Wht	31	4.3	33	4.6	
102-6883	Intermediate Nozzle	 Brown	38	2.8	38	2.8	
102-6884	Intermediate Nozzle	 Yellow	41	4.1	43	4.5	
102-6885	Intermediate Nozzle	 Green	42	5.4	45	6.0	
102-2925	Intermediate Nozzle	 Blue	40	2.8	42	3.2	
102-2926	Intermediate Nozzle	 Orange	44	4.3	45	4.8	
102-2927	Intermediate Nozzle	 Gray	46	5.1	47	5.4	
102-2928	Intermediate Nozzle	 Red	48	6.5	50	7.0	
102-2929	Intermediate Nozzle	 Beige	51	8.1	53	9.1	









# T7 Series Golf Rotors

## Specifications

### Operational

- **Inlet size:** 1" threaded ACME
- **Radius:**
  - Low-flow models: 38' – 56'
  - High-flow models: 46' – 75'
- **Flow rate:**
  - Low-flow models: 1.7 – 13.0 gpm;
  - 6 nozzle trees included with each head (2, 3, 4.5, 6, 7.5 and 9)
  - High-flow models: 6.8 – 30.5 gpm;
  - 7 nozzle trees included with each head (7, 9, 12, 16, 20, 24 and 27)
- **Operating pressure:** 40-100 psi
- **Arc adjustment:** 45° - 360° (uni-directional at 360°)

### Warranty

- Five years

### Top Arc Indication

Arc setting indicator on top of the rotor allows for easy wet or dry adjustments. Part or full-circle from 45° to 360°.



### Dimensions

- **Body diameter:** 2.7"
- **Body height:** 8.8"
- **Rubber cover diameter:** 2.2"
- **Pop-up height to nozzle:** 5.75"

### Model Choices

- ✓ Plastic or stainless steel models
- ✓ Low-Flow or High-Flow models
- ✓ Effluent water indicator models





# T7 Series Golf Rotors

## Nozzle Performance Data - High Flow Models

Nozzle	psi	Radius (ft)	gpm	Precip. Rate (in/hr) ▲	Precip. Rate (in/hr) ■
7.0	40	46	6.6	0.72	0.62
	50	47	7.4	0.75	0.65
	60	48	8.1	0.78	0.68
	70	49	8.8	0.82	0.71
	80	51	9.4	0.83	0.72
	90	52	10.3	0.85	0.73
	100	54	10.7	0.83	0.72
9.0	40	47	7.4	0.76	0.66
	50	50	8.3	0.73	0.64
	60	51	8.7	0.76	0.66
	70	52	9.4	0.81	0.70
	80	54	9.9	0.80	0.69
	90	55	10.9	0.82	0.71
	100	56	11.5	0.84	0.73
12.0*	40	50	9.5	0.89	0.77
	50	51	11.6	0.90	0.78
	60	53	12.7	0.91	0.79
	70	54	13.8	0.96	0.83
	80	55	14.7	0.99	0.86
	90	56	15.6	1.02	0.88
	100	57	16.5	1.04	0.90
16.0	40	53	13.0	1.06	0.92
	50	56	15.1	1.06	0.92
	60	58	16.2	1.04	0.90
	70	59	17.5	1.09	0.95
	80	61	18.8	1.10	0.95
	90	62	20.0	1.14	0.98
	100	63	21.1	1.17	1.01
20.0	40	53	16.0	1.28	1.10
	50	58	17.5	1.22	1.05
	60	60	19.5	1.21	1.05
	70	61	20.6	1.26	1.09
	80	65	22.2	1.19	1.03
	90	66	23.6	1.23	1.06
	100	67	24.8	1.25	1.09
24.0	40	52	15.8	1.27	1.10
	50	60	17.5	1.09	0.95
	60	63	19.3	1.11	0.96
	70	65	20.7	1.14	0.99
	80	67	22.3	1.15	1.00
	90	68	23.8	1.20	1.04
	100	71	25.3	1.16	1.01
27.0	40	55	18.7	1.42	1.23
	50	65	23.4	1.16	1.00
	60	71	23.6	1.05	0.91
	70	72	25.8	1.10	0.95
	80	73	27.4	1.14	0.99
	90	74	29.1	1.18	1.02
	100	75	30.6	1.21	1.05

## Nozzle Performance Data - Low Flow Models

Nozzle	psi	Radius (ft)	gpm	Precip. Rate (in/hr) ▲	Precip. Rate (in/hr) ■
2.0	40	39	1.7	0.25	0.22
	50	39	2.0	0.29	0.25
	60	40	2.2	0.30	0.26
	70	40	2.4	0.33	0.28
	80	40	2.6	0.35	0.31
	90	41	2.7	0.36	0.31
	100	41	2.9	0.38	0.33
3.0*	40	39	2.4	0.36	0.31
	50	40	2.8	0.39	0.33
	60	41	3.1	0.41	0.36
	70	41	3.4	0.45	0.39
	80	42	3.6	0.46	0.40
	90	42	3.9	0.47	0.41
	100	43	4.1	0.49	0.42
4.5	40	38	4.1	0.63	0.54
	50	41	4.7	0.62	0.53
	60	41	5.2	0.68	0.59
	70	42	5.7	0.71	0.62
	80	42	6.1	0.77	0.66
	90	43	6.5	0.78	0.68
	100	43	6.9	0.83	0.72
6.0	40	43	5.0	0.59	0.51
	50	46	5.7	0.59	0.51
	60	48	6.3	0.61	0.52
	70	49	7.0	0.65	0.57
	80	49	7.4	0.68	0.59
	90	50	7.9	0.70	0.61
	100	50	8.4	0.74	0.64
7.5	40	44	5.8	0.66	0.58
	50	46	6.7	0.70	0.60
	60	48	7.4	0.71	0.62
	70	49	8.0	0.75	0.65
	80	50	8.8	0.78	0.67
	90	50	9.5	0.84	0.73
	100	52	10.0	0.81	0.70
9.0	40	45	7.4	0.81	0.70
	50	49	8.5	0.78	0.68
	60	51	9.4	0.80	0.70
	70	53	10.4	0.83	0.72
	80	55	11.3	0.83	0.72
	90	55	12.0	0.89	0.77
	100	56	12.8	0.90	0.78

\* When the sprinkler is adjusted to 360°, it will be uni-directional in that direction of rotation (clockwise or counterclockwise) at the moment when the sprinkler was changed to 360°  
 \* Pre-installed nozzle. Data based on 180°.

### Specifying Information — T7 Series Rotors

T7PSS-42XX			
Description	Optional	Thread	Optional
<b>T7P</b>	<b>SS</b>	<b>42</b>	<b>X</b>
T7P—Sports Rotor	SS—Stainless Steel Riser	42—ACME Thread	E—Effluent L—Low Flow
<b>Example:</b> A low flow T7P sprinkler with a stainless steel riser and effluent rubber cover would be specified as <b>T7PSS-42LE</b>			



# 690 Series Golf Sprinklers

## Specifications

### Operational

- **Inlet:** 1½" NPT
- **Radius:** 87' – 108'
- **Flow Rate:** 51.0 – 82.2 gpm
- **Recommended Operating Pressure Range:** 80-100 psi  
**Maximum pressure:** 150 psi  
**Minimum pressure:** 40 psi
- **Electric Valve-In-Head Solenoid:** 24V ac, 50/60 Hz  
 - Inrush: 60 Hz, 0.30 Amps  
 - Holding: 60 Hz, 0.20 Amps
- **Check-O-Matic:** Maintains 37' of elevation

### Dimensions

- Body diameter: 10"
- Body height: 16"
- Rubber cover diameter: 5.6"
- Pop-up height to nozzle: ¾"

### Warranty

- Three years
- Five years when installed with Toro® Swing Joints

### Model Choices

- ✓ 696 2-Speed Models
- ✓ 698 2-Speed Models

### 690 Series Performance Chart

Base Pressure	Nozzle Set 90		Nozzle Set 91		Nozzle Set 92	
	Radius	gpm	Radius	gpm	Radius	gpm
psi						
80	87	51.0	96	61.2	100	74.0
100	90	57.1	100	73.5	108	82.2

*Radius shown in feet.  
Sprinkler radius of throw per ASAE standard S398.1.*

### 690 Series Conversions & Riserless Bodies

Model	Description
69A-92	CONV,150DEG,92NOZ
69B-92	CONV,165DEG,92NOZ
69C-92	CONV,195DEG,92NOZ
69D-92	CONV,210DEG,92NOZ
691-91	CONV,90DEG,91NOZ
691-92	CONV,90DEG,92NOZ
692-90	CONV,180DEG,90NOZ
692-91	CONV,180DEG,91NOZ
692-92	CONV,180DEG,92NOZ
694-90	CONV,360DEG,90NOZ
694-91	CONV,360DEG,91NOZ
694-92	CONV,360DEG,92NOZ
696-91	CONV,60X120DEG,2SPD,91NOZ
696-92	CONV,60X120DEG,2SPD,92NOZ
698-91	CONV,180X180DEG,2SPD,91NOZ
698-92	CONV,180X180DEG,2SPD,92NOZ
690-06-1	BODY,RISERLESS,690,ADJPSI,STD
690-06-2	BODY,RISERLESS,690,ADJPSI,SG
690-06-4	BODY,RISERLESS,690,ADJPSI,DCL
690-COM	BODY,RISERLESS,690,CHECK-O-MATIC
690-NO	BODY,RISERLESS,690,NORMALLY OPEN





# 690 Series Golf Sprinklers

## Fixed Arc Drives

Nine fixed arc drive assemblies ensure positive retention of the coverage area with no arc drift.

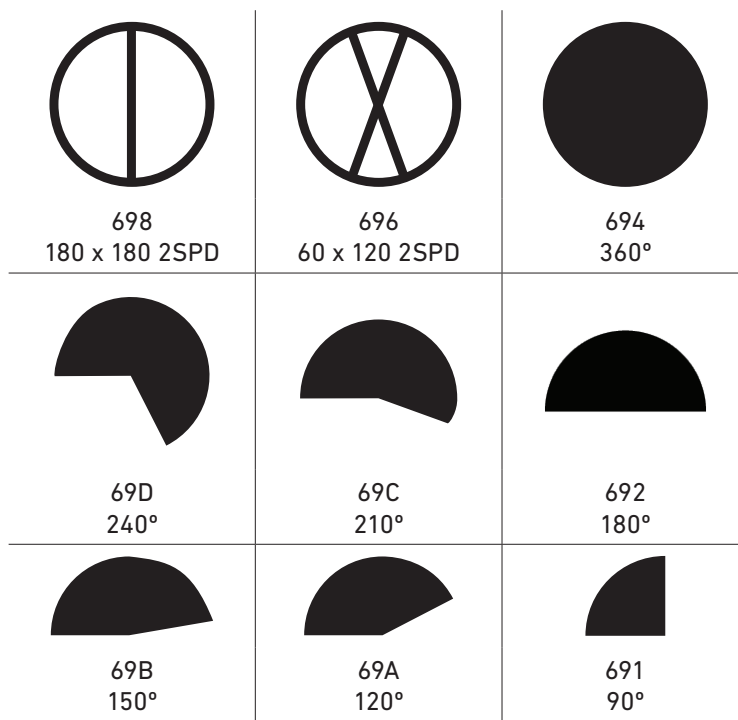

## Specifying Information — 690 Series Rotors

69X-0X-XXX			
Arc	Valve-In-Head Type	Nozzle	Pressure Regulation*
<b>69X</b>	<b>0X</b>	<b>XX</b>	<b>X</b>
1—90°	1—Normally Open	90	8—80 psi
2—180°	Hydraulic	91	1—100 psi
4—Full-circle	2—Check-O-Matic	92	
6—Full-circle, 2-speed (60°–120°)	6—Electric		
8—Full-circle, 2-speed (180°–180°)			

**Example:** When specifying a 690 Series Sprinkler with a 180° arc, electric valve-in-head, #91 nozzle, and pressure regulation at 80 Psi, you would specify: **692-06-918**

\*Electric models only.



# 590 Series Golf Sprinklers

## Specifications

### Operational

- **Radius:** 2' – 26'
- **Recommended pressure range:** 25-50 psi (maximum – 75 psi)
- **Pressure regulation** to 30 psi, optional
- **Flow rate:** 0.05 – 4.5 gpm
- **2 gpm flush rate**

### Dimensions

- **Body diameter:**
  - 1 3/8" on 4P and 6P
  - 1 5/8" on 12P
- **Cap diameter:** 2"
- **Inlet:** 1/2" female-threaded

### Warranty

- Three years

### Risers & Extenders

- **570-6X**
  - Male-inlet threads install onto any 590G sprinkler to provide a 6" extension
  - **Maximum pressure:** 75 psi
- **570SR-6 and 570SR-18 Risers**
  - 1/2" male-threaded inlet for installation on pipe fittings
  - Maximum pressure: 75 psi
  - Height: 6" and 18"



### Nozzle Options

In addition to the full line of Toro® MPR, TVAN and specialty nozzles, the 590GF accepts the revolutionary Precision™ Spray with optimized distribution uniformity that provides exceptional turf conditions with minimal water usage.

### Specifying Information — 590GF Series Rotors

590GF-XX-E		
Model	Pop-Up Height	Optional
<b>590GF</b>	<b>XX</b>	<b>E</b>
590GF—590GF Series Sprays	4—4" Pop-Up 6—6" Pop-Up 12—12" Pop-Up	E—Effluent PR—Pressure Regulated PRE—Pressure Regulated & Effluent





# Precision™ Series Spray Nozzles

## Specifications

### Operational

- **Radius:** 5'-15'
- **Operating pressure range:** 20-75 psi
- **Recommended operating pressure:** Non-Pressure Compensating—30 psi, Pressure Compensating—50 psi
- **Flow Rate:** 0.04-2.4 gpm
- **Nozzle trajectory:** 5': 5°, 8': 10°, and 10': 15°

### Warranty

- Two years



### Precision™ Series Spray Nozzle (PSN) Model List

5' NOZZLE (RED)			8' NOZZLE (GREEN)		
Male	Female	Pattern	Male	Female	Pattern
O-T-5-60	O-5-60	60° Arc	O-T-8-60	O-8-60	60° Arc
O-T-5-Q	O-5-Q	90° Arc	O-T-8-Q	O-8-Q	90° Arc
O-T-5-T	O-5-T	120° Arc	O-T-8-T	O-8-T	120° Arc
O-T-5-150	O-5-150	150° Arc	O-T-8-150	O-8-150	150° Arc
O-T-5-H	O-5-H	180° Arc	O-T-8-H	O-8-H	180° Arc
O-T-5-210	O-5-210	210° Arc	O-T-8-210	O-8-210	210° Arc
O-T-5-TT	O-5-TT	240° Arc	O-T-8-TT	O-8-TT	240° Arc
O-T-5-TQ	O-5-TQ	270° Arc	O-T-8-TQ	O-8-TQ	270° Arc
O-T-5-F	O-5-F	360° Arc	O-T-8-F	O-8-F	360° Arc
10' NOZZLE (BLUE)			12' NOZZLE (BROWN)		
Male	Female	Pattern	Male	Female	Pattern
O-T-10-60	O-10-60	60° Arc	O-T-12-60	O-12-60	60° Arc
O-T-10-Q	O-10-Q	90° Arc	O-T-12-Q	O-12-Q	90° Arc
O-T-10-T	O-10-T	120° Arc	O-T-12-T	O-12-T	120° Arc
O-T-10-150	O-10-150	150° Arc	O-T-12-150	O-12-150	150° Arc
O-T-10-H	O-10-H	180° Arc	O-T-12-H	O-12-H	180° Arc
O-T-10-210	O-10-210	210° Arc	O-T-12-210	O-12-210	210° Arc
O-T-10-TT	O-10-TT	240° Arc	O-T-12-TT	O-12-TT	240° Arc
O-T-10-TQ	O-10-TQ	270° Arc	O-T-12-TQ	O-12-TQ	270° Arc
O-T-10-F	O-10-F	360° Arc	O-T-12-F	O-12-F	360° Arc
15' NOZZLE (BLACK)			SPECIAL PATTERNS (GREY)		
Male	Female	Pattern	Male	Female	Pattern
O-T-15-60	O-15-60	60° Arc			
O-T-15-Q	O-15-Q	90° Arc			
O-T-15-T	O-15-T	120° Arc	O-T-4X9-RCS	O-4X9-RCS	Right Corner
O-T-15-150	O-15-150	150° Arc	O-T-4X9-LCS	O-4X9-LCS	Left Corner
O-T-15-H	O-15-H	180° Arc	O-T-4X18-SST	O-4X18-SST	Side Strip
O-T-15-210	O-15-210	210° Arc	O-T-4X15-RCS	O-4X15-RCS	Right Corner
O-T-15-TT	O-15-TT	240° Arc	O-T-4X15-LCS	O-4X15-LCS	Left Corner
O-T-15-TQ	O-15-TQ	270° Arc	O-T-4X30-SST	O-4X30-SST	Side Strip
O-T-15-F	O-15-F	360° Arc			

### Pressure-Compensating PSN Model List

5' NOZZLE (RED)			8' NOZZLE (GREEN)		
Male	Female	Pattern	Male	Female	Pattern
O-T-5-60P	O-5-60P	60° Arc	O-T-8-60P	O-8-60P	60° Arc
O-T-5-QP	O-5-QP	90° Arc	O-T-8-QP	O-8-QP	90° Arc
O-T-5-TP	O-5-TP	120° Arc	O-T-8-TP	O-8-TP	120° Arc
O-T-5-150P	O-5-150P	150° Arc	O-T-8-150P	O-8-150P	150° Arc
O-T-5-HP	O-5-HP	18° Arc	O-T-8-HP	O-8-HP	18° Arc
O-T-5-210P	O-5-210P	210° Arc	O-T-8-210P	O-8-210P	210° Arc
O-T-5-TTP	O-5-TTP	240° Arc	O-T-8-TTP	O-8-TTP	240° Arc
O-T-5-TQP	O-5-TQP	270° Arc	O-T-8-TQP	O-8-TQP	270° Arc
O-T-5-FP	O-5-FP	360° Arc	O-T-8-FP	O-8-FP	360° Arc
10' NOZZLE (BLUE)			12' NOZZLE (BROWN)		
Male	Female	Pattern	Male	Female	Pattern
O-T-10-60P	O-10-60P	60° Arc	O-T-12-60P	O-12-60P	60° Arc
O-T-10-QP	O-10-QP	90° Arc	O-T-12-QP	O-12-QP	90° Arc
O-T-10-TP	O-10-TP	120° Arc	O-T-12-TP	O-12-TP	120° Arc
O-T-10-150P	O-10-150P	150° Arc	O-T-12-150P	O-12-150P	150° Arc
O-T-10-HP	O-10-HP	18° Arc	O-T-12-HP	O-12-HP	18° Arc
O-T-10-210P	O-10-210P	210° Arc	O-T-12-210P	O-12-210P	210° Arc
O-T-10-TTP	O-10-TTP	240° Arc	O-T-12-TTP	O-12-TTP	240° Arc
O-T-10-TQP	O-10-TQP	270° Arc	O-T-12-TQP	O-12-TQP	270° Arc
O-T-10-FP	O-10-FP	360° Arc	O-T-12-FP	O-12-FP	360° Arc
15' NOZZLE (BLACK)			SPECIAL PATTERNS (GREY)		
Male	Female	Pattern	Male	Female	Pattern
O-T-15-60P	O-15-60P	60° Arc			
O-T-15-QP	O-15-QP	90° Arc			
O-T-15-TP	O-15-TP	120° Arc	O-T-4X9-RCSP	O-4X9-RCSP	Right Corner
O-T-15-150P	O-15-150P	150° Arc	O-T-4X9-LCSP	O-4X9-LCSP	Left Corner
O-T-15-HP	O-15-HP	18° Arc	O-T-4X18-SSTP	O-4X18-SSTP	Side Strip
O-T-15-210P	O-15-210P	210° Arc	O-T-4X15-RCSP	O-4X15-RCSP	Right Corner
O-T-15-TTP	O-15-TTP	240° Arc	O-T-4X15-LCSP	O-4X15-LCSP	Left Corner
O-T-15-TQP	O-15-TQP	270° Arc	O-T-4X30-SSTP	O-4X30-SSTP	Side Strip
O-T-15-FP	O-15-FP	360° Arc			

### Specifying Information — Precision™ Series Spray Nozzle

O-X-XXXX-XXXX-P				
Nozzle	Thread	Radius	Arc	PCD
O	X	XXXX	XXXX	P
O—1" Per Hour	T—Toro Male-Threaded Nozzle Blank—Female-Threaded Nozzle	5—5' 8—8' 10—10' 12—12' 15—15' 4X15—4'X15' (PCD models only) 4X30—4'X30' (PCD models only) 4X9—4'X9' 4X18—4'X18'	60—60* Q—90° T—120° 150—150* H—180° 210—210* TT—240° TQ—270° F-360°—Full-circle LCS—Left Corner RCS—Right Corner SST—Side Strip	P—Pressure Compensating
<b>Example:</b> A female-threaded Precision™ Series Spray with a spray radius of 12' and a 90° arc would be specified as: O-12-Q				
<b>Example 2:</b> A male-threaded Pressure-Compensating Precision™ Series Spray with a spray radius of 10' and a 180° arc would be specified as O-T-10-HP				

\*Not available with Pressure Compensating.



# Precision™ Series Spray Nozzles

## Performance Data

Five Radii Available in Toro® (Male) & Female Threads

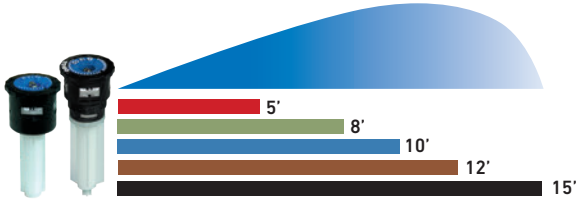

### Performance Data Pressure Compensating – Precision™ Series Spray Nozzles

Arc	model # (O-XX-XX)	psi	gpm	Radius	Precip. Rate ■ (in./hr.)	Precip. Rate ▲ (in./hr.)	model # (O-XX-XX)	psi	gpm	Radius	Precip. Rate ■ (in./hr.)	Precip. Rate ▲ (in./hr.)	model # (O-XX-XX)	psi	gpm	Radius	Precip. Rate ■ (in./hr.)	Precip. Rate ▲ (in./hr.)
60°	5-60P	40	0.07	6.0	1.2	1.4	8-60P	40	0.11	7.5	1.1	1.3	10-60P	40	0.16	9.5	1.0	1.2
		50	0.07	5.5	1.3	1.5		50	0.11	7.5	1.2	1.3		50	0.18	10.5	1.0	1.1
		60	0.07	6.0	1.0	1.2		60	0.12	7.5	1.3	1.4		60	0.20	11.0	1.0	1.1
		70	0.08	6.5	1.0	1.2		70	0.14	8.0	1.2	1.4		70	0.22	11.0	1.1	1.2
90°	5-QP	40	0.06	4.6	1.0	1.2	8-QP	40	0.14	7.0	1.1	1.3	10-QP	40	0.26	9.5	1.0	1.1
		50	0.08	5.1	1.2	1.4		50	0.17	7.7	1.2	1.3		50	0.28	10.0	1.1	1.2
		60	0.09	5.6	1.3	1.5		60	0.20	8.4	1.2	1.4		60	0.29	10.5	1.1	1.3
		70	0.11	6.2	1.5	1.7		70	0.23	9.1	1.3	1.4		70	0.31	11.1	1.2	1.4
120°	5-TP	40	0.07	4.4	1.0	1.1	8-TP	40	0.20	7.6	1.0	1.2	10-TP	40	0.31	9.5	1.0	1.1
		50	0.11	4.9	1.3	1.5		50	0.24	8.0	1.1	1.3		50	0.36	10.0	1.1	1.2
		60	0.15	5.5	1.7	2.0		60	0.27	8.5	1.2	1.4		60	0.41	10.5	1.2	1.4
		70	0.19	6.0	2.0	2.4		70	0.31	8.9	1.3	1.5		70	0.46	11.0	1.3	1.5
150°	5-150P	40	0.14	6.0	0.9	1.0	8-150P	40	0.32	8.0	1.1	1.3	10-150P	40	0.47	9.5	1.2	1.4
		50	0.14	6.0	0.9	1.0		50	0.32	8.5	1.0	1.2		50	0.49	10.0	1.1	1.3
		60	0.14	6.0	0.9	1.0		60	0.32	8.0	1.1	1.3		60	0.51	10.0	1.2	1.4
		70	0.14	6.0	0.9	1.0		70	0.32	8.0	1.1	1.3		70	0.53	10.5	1.1	1.3
180°	5-HP	40	0.10	4.4	1.0	1.2	8-HP	40	0.26	7.0	1.0	1.2	10-HP	40	0.48	9.7	1.0	1.1
		50	0.13	4.9	1.1	1.3		50	0.33	7.6	1.1	1.3		50	0.53	10.1	1.1	1.2
		60	0.16	5.4	1.3	1.5		60	0.39	8.1	1.2	1.4		60	0.57	10.4	1.1	1.3
		70	0.19	6.0	1.4	1.6		70	0.46	8.7	1.3	1.5		70	0.62	10.8	1.2	1.4
210°	5-210P	40	0.16	5.0	1.1	1.2	8-210P	40	0.34	8.0	0.9	1.0	10-210P	40	0.57	9.5	1.1	1.2
		50	0.18	5.5	1.0	1.1		50	0.38	8.0	1.0	1.1		50	0.64	10.0	1.1	1.2
		60	0.20	6.0	0.9	1.1		60	0.42	8.0	1.1	1.3		60	0.70	10.0	1.2	1.3
		70	0.21	6.0	1.0	1.1		70	0.45	8.0	1.2	1.3		70	0.75	10.0	1.2	1.4
240°	5-TTP	40	0.14	4.3	1.1	1.3	8-TTP	40	0.34	7.0	1.0	1.1	10-TTP	40	0.63	9.6	1.0	1.1
		50	0.20	4.9	1.3	1.5		50	0.43	7.8	1.1	1.2		50	0.70	9.9	1.1	1.2
		60	0.25	5.4	1.4	1.7		60	0.52	8.5	1.2	1.4		60	0.77	10.3	1.1	1.3
		70	0.31	6.0	1.6	1.8		70	0.61	9.3	1.3	1.5		70	0.84	10.6	1.2	1.4
270°	5-TQP	40	0.15	4.3	1.0	1.2	8-TQP	40	0.41	7.2	1.0	1.1	10-TQP	40	0.71	9.5	1.0	1.1
		50	0.21	4.9	1.2	1.4		50	0.48	7.9	1.1	1.2		50	0.77	9.9	1.0	1.2
		60	0.26	5.6	1.4	1.6		60	0.55	8.6	1.2	1.4		60	0.82	10.3	1.1	1.2
		70	0.32	6.2	1.5	1.7		70	0.62	9.3	1.3	1.5		70	0.88	10.7	1.1	1.3
360°	5-FP	40	0.17	4.0	1.0	1.2	8-FP	40	0.55	7.0	1.1	1.2	10-FP	40	0.95	9.6	1.0	1.1
		50	0.24	4.8	1.1	1.3		50	0.65	7.5	1.1	1.2		50	1.06	10.0	1.1	1.2
		60	0.31	5.5	1.2	1.4		60	0.74	8.0	1.1	1.3		60	1.16	10.5	1.1	1.3
		70	0.38	6.3	1.3	1.5		70	0.84	8.5	1.1	1.3		70	1.27	10.9	1.2	1.4



# Precision™ Series Spray Nozzles

## Performance Data

Nine Arcs, Plus Side and Center Strips Available

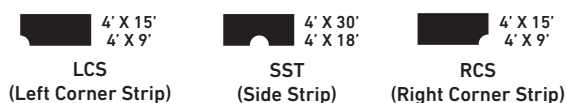

### Performance Data Pressure Compensating – Precision™ Series Spray Nozzles

Arc	model # (O-XX-XX)	psi	gpm	Radius	Precip. Rate (in./hr.)	Precip. Rate (in./hr.)	model # (O-XX-XX)	psi	gpm	Radius	Precip. Rate (in./hr.)	Precip. Rate (in./hr.)	Arc	psi	gpm	Radius	Precip. Rate (in./hr.)	Precip. Rate (in./hr.)
60°	12-60P	40	0.30	13.0	1.0	1.2	15-60P	40	0.36	14.0	1.1	1.2	4X30 SSTP	40	0.62	4x30	1.0	1.1
		50	0.30	13.0	1.0	1.2		50	0.41	15.0	1.0	1.2		50	0.65	4x30	1.0	1.2
		60	0.30	13.0	1.0	1.2		60	0.45	15.0	1.1	1.3		60	0.67	4x30	1.1	1.3
		70	0.30	13.0	1.0	1.2		70	0.48	15.0	1.2	1.4		70	0.70	4x30	1.1	1.3
90°	12-QP	40	0.34	12.0	1.0	1.2	15-QP	40	0.53	14.2	1.0	1.2	4X15 LCSP	40	0.32	4x15	1.0	1.2
		50	0.39	12.2	1.1	1.3		50	0.59	14.5	1.1	1.2		50	0.33	4x15	1.1	1.2
		60	0.43	12.5	1.2	1.3		60	0.64	14.8	1.1	1.3		60	0.34	4x15	1.1	1.3
		70	0.48	12.7	1.2	1.4		70	0.70	15.1	1.2	1.3		70	0.35	4x15	1.2	1.3
120°	12-TP	40	0.46	11.5	1.0	1.2	15-TP	40	0.72	14.3	1.0	1.2	4X15 RCSP	40	0.32	4x15	1.0	1.2
		50	0.50	11.8	1.0	1.2		50	0.77	14.8	1.0	1.2		50	0.33	4x15	1.1	1.2
		60	0.54	12.0	1.1	1.3		60	0.82	15.2	1.1	1.2		60	0.34	4x15	1.1	1.3
		70	0.58	12.3	1.1	1.3		70	0.87	15.7	1.1	1.2		70	0.35	4x15	1.2	1.3
150°	12-150P	40	0.59	12.0	1.0	1.1	15-150P	40	0.93	14.0	1.1	1.3	4X18 SSTP	40	0.36	4x18	1.0	1.1
		50	0.66	11.5	1.2	1.3		50	1.04	14.5	1.2	1.3		50	0.37	4x18	1.0	1.2
		60	0.72	12.0	1.2	1.3		60	1.14	14.5	1.3	1.5		60	0.38	4x18	1.0	1.2
		70	0.78	12.0	1.3	1.5		70	1.23	14.5	1.4	1.6		70	0.39	4x18	1.0	1.2
180°	12-HP	40	0.70	11.5	1.0	1.2	15-HP	40	1.10	14.5	1.0	1.2	4X9 LCSP	40	0.18	4x9	1.0	1.1
		50	0.75	11.8	1.0	1.2		50	1.20	14.3	1.1	1.2		50	0.19	4x9	1.1	1.2
		60	0.80	12.2	1.1	1.2		60	1.29	14.0	1.1	1.3		60	0.20	4x9	1.1	1.2
		70	0.85	12.5	1.1	1.2		70	1.39	13.8	1.2	1.3		70	0.21	4x9	1.2	1.3
210°	12-210P	40	0.86	11.0	1.2	1.4	15-210P	40	1.23	14.0	1.0	1.2	4X9 RCSP	40	0.18	4x9	1.0	1.2
		50	0.96	11.5	1.2	1.4		50	1.44	14.0	1.2	1.4		50	0.19	4x9	1.1	1.2
		60	1.05	12.0	1.2	1.4		60	1.56	14.0	1.3	1.5		60	0.20	4x9	1.1	1.2
		70	1.13	12.0	1.3	1.5		70	1.70	15.0	1.2	1.4		70	0.21	4x9	1.2	1.3
240°	12-TTP	40	0.90	11.4	1.0	1.2	15-TTP	40	1.45	14.5	1.0	1.2	12-TQP	40	1.05	11.4	1.0	1.2
		50	1.03	11.5	1.1	1.3		50	1.57	14.8	1.0	1.2		50	1.14	11.7	1.0	1.2
		60	1.16	11.5	1.2	1.3		60	1.68	15.0	1.1	1.2		60	1.23	12.0	1.1	1.3
		70	1.29	11.6	1.2	1.4		70	1.80	15.3	1.1	1.3		70	1.32	12.3	1.1	1.3
270°	12-TQP	40	1.05	11.4	1.0	1.2	15-TQP	40	1.60	14.0	0.9	1.0	12-FP	40	1.35	11.5	1.0	1.1
		50	1.14	11.7	1.0	1.2		50	1.70	14.4	1.0	1.1		50	1.49	11.8	1.0	1.2
		60	1.23	12.0	1.1	1.3		60	1.80	14.8	1.0	1.2		60	1.63	12.2	1.1	1.3
		70	1.32	12.3	1.1	1.3		70	1.90	15.1	1.1	1.2		70	1.77	12.5	1.1	1.3
360°	12-FP	40	1.35	11.5	1.0	1.1	15-FP	40	2.20	14.5	1.0	1.2						
		50	1.49	11.8	1.0	1.2		50	2.36	14.8	1.0	1.2						
		60	1.63	12.2	1.1	1.3		60	2.52	15.1	1.1	1.2						
		70	1.77	12.5	1.1	1.3		70	2.68	15.4	1.1	1.3						



# Precision™ Series Spray Nozzles

## Performance Data

Five Radii Available in Toro® (Male) & Female Threads

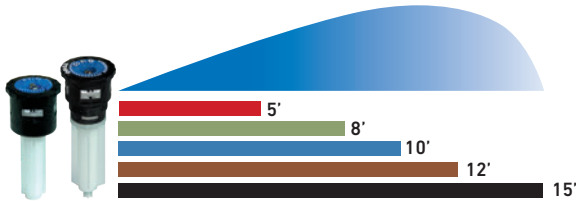

### Performance Data – Precision™ Series Spray Nozzles

Arc	model # (O-XX-XX)	psi	gpm	Radius	Precip. Rate ■ (in./hr.)	Precip. Rate ▲ (in./hr.)	model # (O-XX-XX)	psi	gpm	Radius	Precip. Rate ■ (in./hr.)	Precip. Rate ▲ (in./hr.)	model # (O-XX-XX)	psi	gpm	Radius	Precip. Rate ■ (in./hr.)	Precip. Rate ▲ (in./hr.)
60°	5-60	20	0.04	4.7	1.0	1.2	8-60	20	0.10	7.6	1.0	1.2	10-60	20	0.16	9.5	1.0	1.2
		30	0.04	5.0	1.0	1.2		30	0.11	8.0	1.0	1.1		30	0.17	10.0	1.0	1.1
		40	0.04	5.0	1.0	1.2		40	0.12	8.1	1.1	1.2		40	0.18	10.0	1.0	1.2
		50	0.05	5.3	1.0	1.1		50	0.13	8.3	1.1	1.3		50	0.19	10.0	1.1	1.3
90°	5-Q	20	0.06	4.6	1.0	1.2	8-Q	20	0.14	7.0	1.1	1.3	10-Q	20	0.26	9.5	1.0	1.1
		30	0.06	5.0	1.0	1.1		30	0.17	8.0	1.0	1.1		30	0.23	10.0	1.0	1.2
		40	0.07	5.0	1.0	1.2		40	0.18	8.2	1.0	1.2		40	0.28	1.2	1.0	1.2
		50	0.07	5.0	1.0	1.2		50	0.18	8.4	1.0	1.1		50	0.28	1.3	1.0	1.2
120°	5-T	20	0.07	4.4	1.0	1.2	8-T	20	0.20	7.6	1.0	1.2	10-T	20	0.31	9.5	1.0	1.1
		30	0.09	5.0	1.0	1.2		30	0.22	8.0	1.0	1.1		30	0.34	10.0	1.0	1.1
		40	0.09	5.2	1.0	1.2		40	0.23	8.2	1.0	1.1		40	0.36	10.0	1.0	1.2
		50	0.10	5.4	1.0	1.1		50	0.24	8.3	1.0	1.1		50	0.37	10.0	1.1	1.2
150°	5-150	20	0.07	4.0	1.0	1.2	8-150	20	0.25	7.5	1.0	1.2	10-150	20	0.41	9.8	1.0	1.1
		30	0.11	5.0	1.0	1.2		30	0.27	8.0	1.0	1.1		30	0.43	10.0	1.0	1.1
		40	0.12	5.2	1.0	1.2		40	0.28	8.1	1.0	1.1		40	0.44	10.2	1.0	1.1
		50	0.13	5.4	1.0	1.2		50	0.29	8.2	1.0	1.2		50	0.46	10.4	1.0	1.1
180°	5-H	20	0.10	4.4	1.0	1.2	8-H	20	0.26	7.0	1.0	1.2	10-H	20	0.48	9.7	1.0	1.1
		30	0.13	5.0	1.0	1.2		30	0.33	8.0	1.0	1.1		30	0.51	10.0	1.0	1.1
		40	0.14	5.1	1.0	1.2		40	0.34	8.0	1.0	1.2		40	0.55	10.3	1.0	1.2
		50	0.14	5.2	1.0	1.1		50	0.34	8.0	1.0	1.2		50	0.56	10.4	1.0	1.2
210°	5-210	20	0.10	4.4	1.0	1.2	8-210	20	0.33	7.6	1.1	1.3	10-210	20	0.56	9.8	1.1	1.3
		30	0.15	5.2	1.1	1.2		30	0.36	8.0	1.1	1.3		30	0.58	10.0	1.1	1.3
		40	0.16	5.3	1.1	1.3		40	0.37	8.1	1.1	1.3		40	0.60	10.4	1.1	1.2
		50	0.17	5.5	1.1	1.3		50	0.38	8.2	1.1	1.3		50	0.62	10.5	1.1	1.3
240°	5-TT	20	0.14	4.3	1.1	1.3	8-TT	20	0.34	7.0	1.0	1.2	10-TT	20	0.63	9.6	1.0	1.1
		30	0.17	5.0	1.0	1.1		30	0.44	8.0	1.0	1.1		30	0.69	10.0	1.0	1.2
		40	0.19	5.0	1.1	1.2		40	0.46	8.0	1.0	1.2		40	0.73	10.3	1.0	1.1
		50	0.19	5.0	1.1	1.3		50	0.46	8.0	1.0	1.2		50	0.74	10.4	1.0	1.1
270°	5-TQ	20	0.15	4.3	1.0	1.2	8-TQ	20	0.41	7.2	1.0	1.1	10-TQ	20	0.71	9.5	1.0	1.1
		30	0.20	5.0	1.0	1.2		30	0.49	8.0	1.1	1.1		30	0.79	10.0	1.0	1.1
		40	0.21	5.0	1.1	1.2		40	0.54	8.0	1.1	1.2		40	0.84	10.3	1.0	1.1
		50	0.22	5.0	1.1	1.3		50	0.55	8.0	1.1	1.2		50	0.86	10.4	1.0	1.1
360°	5-F	20	0.17	4.0	1.0	1.2	8-F	20	0.55	7.0	1.1	1.2	10-F	20	0.95	9.6	1.0	1.1
		30	0.26	5.0	1.0	1.2		30	0.66	8.0	1.0	1.1		30	1.03	10.0	1.0	1.1
		40	0.26	5.0	1.0	1.2		40	0.68	8.0	1.0	1.2		40	1.08	10.3	1.0	1.1
		50	0.26	5.0	1.0	1.2		50	0.71	8.0	1.1	1.2		50	1.12	10.4	1.0	1.2



# Precision™ Series Spray Nozzles

## Performance Data

Nine Arcs, Plus Side and Center Strips Available

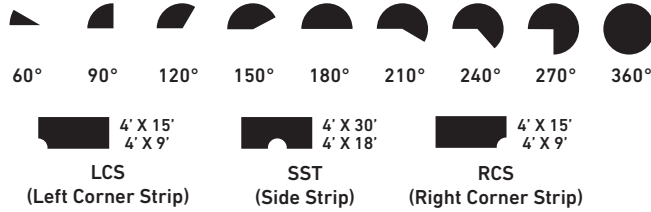

### Performance Data – Precision™ Series Spray Nozzles

Arc	model # (O-XX-XX)	psi	gpm	Radius	Precip. Rate ■ (in./hr.)	Precip. Rate ▲ (in./hr.)	model # (O-XX-XX)	psi	gpm	Radius	Precip. Rate ■ (in./hr.)	Precip. Rate ▲ (in./hr.)	Arc	psi	gpm	Radius	Precip. Rate ■ (in./hr.)	Precip. Rate ▲ (in./hr.)
60°	12-60	20	0.24	11.5	1.0	1.2	15-60	20	0.35	14.0	1.0	1.2	4X30 SST	20	0.62	4x28	1.0	1.1
		30	0.25	12.0	1.0	1.2		30	0.39	15.0	1.0	1.2		30	0.66	4x30	1.1	1.2
		40	0.26	12.1	1.0	1.2		40	0.40	15.1	1.0	1.2		40	0.67	4x30	1.1	1.2
		50	0.28	12.2	1.1	1.3		50	0.42	15.3	1.0	1.2		50	0.68	4x30	1.1	1.3
90°	12-Q	20	0.34	12.0	1.0	1.2	15-Q	20	0.53	14.2	1.0	1.2	4X15 LCS	20	0.32	4x15	1.0	1.2
		30	0.37	12.1	1.0	1.1		30	0.58	15.0	1.0	1.1		30	0.33	4x15	1.1	1.2
		40	0.39	11.4	1.0	1.2		40	0.60	15.1	1.0	1.2		40	0.34	4x15	1.1	1.2
		50	0.39	12.0	1.0	1.1		50	0.61	15.3	1.0	1.2		50	0.34	4x15	1.1	1.3
120°	12-T	20	0.46	11.5	1.0	1.2	15-T	20	0.72	14.3	1.0	1.2	4X15 RCS	20	0.32	4x15	1.0	1.2
		30	0.49	12.0	1.0	1.1		30	0.77	15.0	1.0	1.1		30	0.33	4x15	1.1	1.2
		40	0.51	12.2	1.0	1.1		40	0.81	15.3	1.0	1.2		40	0.34	4x15	1.1	1.3
		50	0.52	12.3	1.0	1.1		50	0.82	15.4	1.0	1.2		50	0.34	4x15	1.1	1.3
150°	12-150	20	0.60	11.6	1.0	1.2	15-150	20	0.92	14.7	1.0	1.2	4X18 SST	20	0.36	4x18	1.0	1.1
		30	0.62	12.0	1.0	1.1		30	0.96	15.0	1.0	1.2		30	0.37	4x18	1.0	1.1
		40	0.63	12.2	1.0	1.1		40	1.00	15.2	1.0	1.2		40	0.38	4x18	1.0	1.2
		50	0.64	12.3	1.0	1.1		50	1.10	15.3	1.1	1.3		50	0.38	4x18	1.0	1.2
180°	12-H	20	0.70	11.5	1.0	1.2	15-H	20	1.10	14.5	1.0	1.2	4X9 LCS	20	0.18	4x9	1.0	1.2
		30	0.74	12.0	1.0	1.1		30	1.16	15.0	1.0	1.1		30	0.19	4x9	1.0	1.2
		40	0.79	12.3	1.0	1.2		40	1.25	15.4	1.0	1.2		40	0.2	4x9	1.1	1.2
		50	0.80	12.4	1.0	1.2		50	1.28	15.5	1.0	1.2		50	0.2	4x9	1.1	1.1
210°	12-210	20	0.76	11.6	1.1	1.3	15-210	20	1.15	14.5	1.1	1.2	4X9 RCS	20	0.18	4x9	1.0	1.2
		30	0.82	12.0	1.1	1.3		30	1.20	15.0	1.0	1.2		30	0.19	4x9	1.0	1.2
		40	0.84	12.3	1.1	1.2		40	1.30	15.5	1.0	1.2		40	0.2	4x9	1.1	1.2
		50	0.85	12.4	1.1	1.2		50	1.40	15.6	1.1	1.3		50	0.2	4x9	1.1	1.1
240°	12-TT	20	0.90	11.4	1.0	1.2	15-TT	20	1.45	14.5	1.0	1.2	15-F	20	2.20	14.5	1.0	1.2
		30	0.99	12.0	1.0	1.1		30	1.54	15.0	1.0	1.1		30	2.31	15.0	1.0	1.1
		40	1.04	12.3	1.0	1.1		40	1.58	15.2	1.0	1.1		40	2.35	15.2	1.0	1.1
		50	1.05	12.4	1.0	1.1		50	1.61	15.3	1.0	1.1		50	2.40	15.3	1.0	1.1
270°	12-TQ	20	1.05	11.4	1.0	1.2	15-TQ	20	1.72	14.5	1.0	1.2	12-F	20	1.35	11.5	1.0	1.1
		30	1.15	12.0	1.0	1.2		30	1.78	15.0	1.0	1.1		30	1.48	12.0	1.0	1.1
		40	1.19	12.2	1.0	1.2		40	1.82	15.0	1.0	1.2		40	1.59	12.4	1.0	1.1
		50	1.22	12.3	1.0	1.2		50	1.90	15.3	1.0	1.2		50	1.60	12.5	1.0	1.1





# Subsurface Irrigation

## Specifications

### Drip System Specifications

#### Bunkers Only

- **Flow range:**
  - Low flow: 0.1 to 8.0 gpm
  - High flow: 2.0 to 20.0 gpm
- **DL2000™ range:**
  - Low flow: 12' to 1000'
  - High flow: 250' to 2500'
- **Pressure compensating emitter:** 0.5 gph
- **Emitter spacing** – 12"
- **DL2000 maximum run length:** 360'
- **Application rate** (12" x 12" spacing): 0.85" per hour

#### Benefits On Bunkers

- Uniformly applies water to areas such as fingers
- Minimizes runoff
- Eliminates overspray into bunker keeping sand dry
- Cycle/soak allows for application on steep slopes
- Reduces bunker cave-ins
- Saves time, labor and money by eliminating the need for hand-watering

#### Benefits On Tees

- Applies water directly to the root zone allowing turf to stay dry
- Water is applied precisely to the tee box without watering the surrounding area

### Bunker System Components

- **DL2000 subsurface dripline**
- **Drip Zone Valve Kit** – includes control valve, pressure regulator, Y-filter and manual ball valve
- **Air Vent Assembly** – pre-assembled and ready to install (bunker only)
- **Required inlet/outlet fittings**
- **Flush Assembly Fittings** (8 gpm) 2 psi sealing flush valve (bunker only)
- **Installation Fittings:**
  - Includes Tri-Loc™ tees, couplings, elbows and end clamps
  - 10' of Blue Stripe® polyethylene tubing
  - Soil staples for secure tubing placement
- **Pipe thread tap**

### Warranty

- Two years





# Subsurface Irrigation

## Specifications

### Specifying Information — Subsurface Irrigation

Model Number	Description
SSDS-LF-500	DL2000™ 500' Drip System (Bunker)—Low Flow
SSDS-HF-1000	DL2000 1000' Drip System (Bunker)—High Flow
RGP-212-05	DL2000 500' (Roll, 0.5 GPH), 12" Spacing

**Example:** A 500' DL2000 Drip System, would be specified as: **SSDS-LF-500**

### Specifying Information — Golf Zone Kits

Model	Description
GZK-25-LF-DCL	P220G valve with DC latching solenoid, 25 psi reg, low flow .1-8 gpm, 150 mesh SS filter
GZK-25-LF-SG	P220G valve with SPIKE GUARD™ solenoid, 25 psi reg, low flow .1-8 gpm, 150 mesh SS filter
GZK-25-MF-DCL	P220G valve with DC latching solenoid, 25 psi reg, medium flow 2-20 gpm, 150 mesh SS filter
GZK-25-MF-SG	P220G valve with SPIKE GUARD solenoid, 25 psi reg, medium flow 2-20 gpm, 150 mesh SS filter
GZK-40-MF-DCL	P220G valve with DC latching solenoid, 40 psi reg, medium flow 2-20 gpm, 150 mesh SS filter
GZK-40-MF-SG	P220G valve with SPIKE GUARD solenoid, 40 psi reg, medium flow 2-20 gpm, 150 mesh SS filter

### Specifying Information — Tri-Loc™ Fittings

Model	Description
TL-C	Tri-Loc Coupling
TL-E	Tri-Loc Elbow
TL-T	Tri-Loc Tee
TL-CAP	Tri-Loc Cap
TL-BV	Tri-Loc Ball Valve
TL-M50	Tri-Loc ½" MPT Adapter Coupling
TL-T-M50	Tri-Loc ½" MPT Adapter Tee
TL-M75	Tri-Loc ¾" MPT Adapter Coupling

### Specifying Information — Accessories

Model	Description
YD-500-34Z-10	Air Vent —½" MIPT Air Release & Vacuum Relief Valve (Bag of 10)
FCH-H-FHT-10	Flush Valve — ¾" FHT (Hose Thread), 0.8 gpm, 2 psi Sealing Pressure (Bag of 10)
FJQ16-10	⅝" Figure-eight End Clamp (Bag of 10)
SS6-50G	¾" Steel Soil Staple to Hold Tubing in Place (Bag of 50)

### Specifying Information — Accessories

Model	Description
REG075251-8	Pressure regulator, ¾" 25 psi, .1-8 gpm
REG100252-20	Pressure regulator, 1" 25 psi, 2-20 gpm

### Specifying Information — Accessories

Model	Description
ALFS75150-SG	Filter, ¾", 150 mesh stainless screen
ALFS10150-SG	Filter, 1", 150 mesh stainless screen
AMP0004-1SG	Filter Replacement, 150 mesh stainless screen



ALFS10150-SG



# Swing Joints

## Specifications

### Warranty

- Five years
- Toro® Golf sprinkler warranty extended to 5 years when purchased and installed with a Toro Swing Joint

### Features

- ✓ Schedule 80 PVC construction
- ✓ Double o-ring swivel joints
- ✓ Low friction loss characteristics
- ✓ 315 psi pressure rating
- ✓ 800 psi burst pressure safety rating
- ✓ Standard models with 2x90 outlet configuration
- ✓ Ultra models with 4x90 outlet for maximum alignment flexibility
- ✓ 3 inlet fittings styles: ACME, male thread and 4" spigot
- ✓ 2 outlet fitting styles: ACME and male thread
- ✓ 8", 12" and 18" lay lengths
- ✓ Saddle Tee models: 2" tee with 1", 1¼" or 1½" outlet
- ✓ Glue Tee models: 2" tee with 1", 1¼" or 1½" outlet
- ✓ Glue 90° models: 2" 90° with 1", 1¼" or 1½" outlet
- ✓ Quick coupler models with Dura-lock anti-rotation feature
- ✓ Compatible with all brands of service and saddle tees

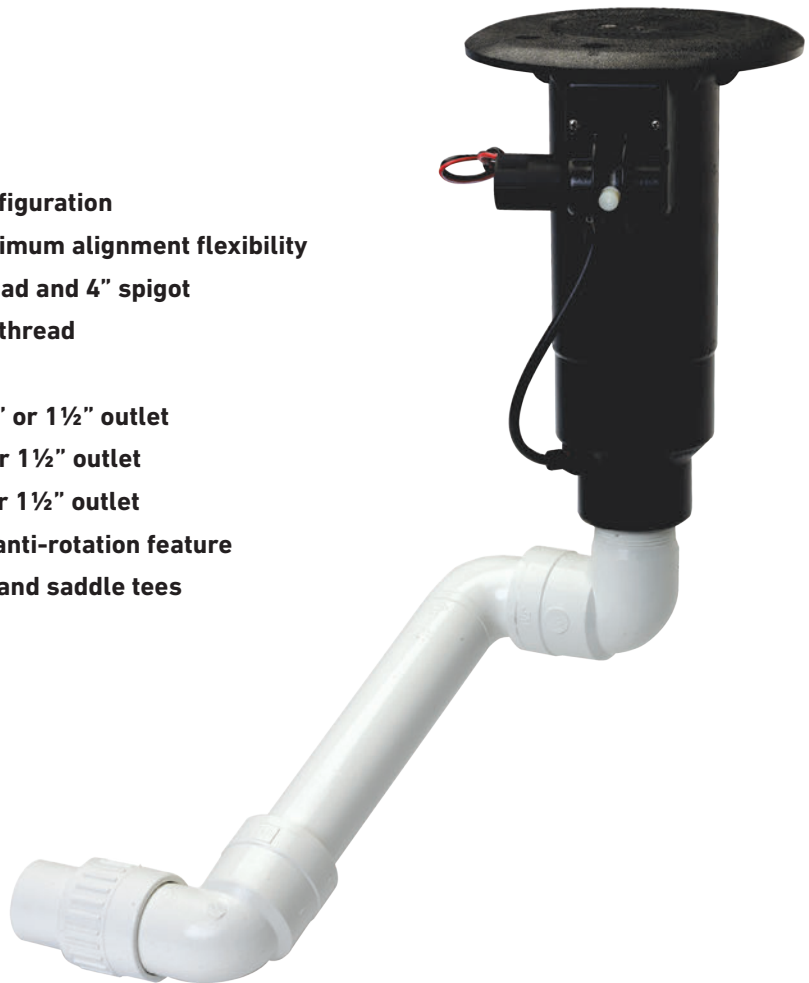

### Toro Tool Tip:

Use a 1¼" hole saw for the 1" Saddle Tee.  
Use a 1½" hole saw for the 1¼" and 1½" Saddles.



# Swing Joints

## Specifications

### Durability & Reliability

Constructed from schedule 80 PVC for durability and provides double o-ring seals on all swing fittings to ensure a lifetime of reliability and leak free performance.



### 1 1/4" Female ACME x 1" Male ACME Adapter

Allows you to upgrade existing Rain Bird® Eagle™\* 700 1 1/4" sprinklers to any Toro 800S or DT Series Sprinkler. P/N TA36-132.



1", 1 1/4", & 1 1/2"



Standard  
2x90 & Ultra 4x90



Quick Coupler



Glue tees, Saddle tees

### Specifying Information — Toro® Swing Joints

TSJ-XXXX-XX-XX-X-XXX*							
Description	Inlet Size	Inlet Type	Size	Length	Number of Elbows	Outlet Size	Outlet Type
TSJ	XX	XX	XX	XX	X	XX	X
TSJ— Toro Swing Joint	10—1" 12—1 1/4" 15—1 1/2"	M—MIPT (male pipe thread) S—4" Spigot A—ACME Thread GE—Glue Elbow GT—Glue Tee ST—Saddle Tee AF—Aqua Fuse	Blank—same as inlet size 10—1" 12—1 1/4" 15—1 1/2"	8—8" Lay Length 12—12" Lay Length 18—18" Lay Length	3—Standard Unibody for Side Pipe Mount 4—Standard Unibody for Top Pipe Mount 5—Ultra Unibody for Side Pipe Mount Q* 6—Ultra Unibody for Top Pipe Mount	10—1" 15—1 1/2"	M—MIPT (Male pipe thread) A—ACME thread QC—Quick Coupler

**Example:** A Toro 1 1/2" Swing Joint with an ACME inlet, 12" lay length, 3 elbows (standard uni-body) and 1 1/2" ACME outlet fitting would be specified as: **TSJ-15A-12-3-15A**

\* Use QC to designate QC when the inlet size and size are the same (TSJ-10A-12-3-10QC) use Q when the inlet size and size are different (TSJ-15A10-12-3-10Q)

\*Rain Bird is a registered trademark of Rain Bird Corporation. Eagle is a trademark of Rain Bird Corporation



# Golf Sprinkler Tools



## 995-15 Selector Tool

- All electric golf sprinklers
- Allows user to manually turn the sprinkler "ON", turn or leave it "OFF" or place it into the "AUTO" position awaiting a command from the controller



## 995-83 Multi Purpose Tool

- All Golf sprinklers
- Riser pull up for INFINITY®, FLEX800™, DT, & 800S Series
- Riser screen removal on all models
- Upper snap ring remover on all models



## 995-82 Arc Adjustment Tool, 3/32" Allen Wrench

- 765, 785, 865S, 885S Arc adjustment of the part circle drives
- INFINITY, FLEX800, DT & 800S Series. Adjustment of the radius reduction screw



## Riser Removal Tools

- **995-85** drive assembly extraction tool 730, 760, 780, 860S, 880S
- Threads onto the drive output shaft and allows removal of the drive from the body



## Nut Driver

- **995-105** 5/16" INFINITY, FLEX800, DT and 800S Series TruJectory™ adjustment on INFX5- 6/ FLX5-6 models - Inner, intermediate and back nozzle removal on all DT and 800S models
- **995-99** 5/8" - Dual trajectory selection - Main nozzle removal on all models
- **995-79** 7/16" 834S/854S pre August 2007 - Inner, intermediate and back nozzle removal - 650/760/780/860S/880S Inner, intermediate and back nozzle removal



## Valve Removal Tools

- **995-08** All 1" golf models and 640
- **995-09** All 1.5" models and 690





# Golf Sprinkler Tools



## Valve Insertion Tools Aligns & Installs Valve into the Body

- **995-35** 640 VIH body
- **995-76** All 1" golf models (Except INFINITY)
- **995-101** All 1.5" golf models (Except INFINITY)
- **995-12** 690 body
- **118-1843** INFINITY® 1.5" models
- **118-1844** INFINITY 1" models



## 995-100 Valve Snap Ring Pliers with Screen Remover

- All Golf sprinklers lower snap ring removal on all models
- Rock screen removal on all INFINITY, FLEX800™, DT & 800S Series
- Valve removal on all models



## Riser Hold Up Tools Allow for Nozzle Servicing

- **118-0954** Riser hold up tool, red
- **995-55** All 700 models
- **995-102** Universal hold up tool, all 700, 800S, DT, INFINITY & FLEX800 models



## PRN TOOL

- Adjustment tool for Precision™ Series Rotating Nozzles
- Adjusts arc and radius



## PNOZZ TOOL Riser Pull Up Tool

- Used on 590GF sprays



## 102-6527

- T7 Rotor adjustment tool



## 118-0954

- Riser hold up tool



# Golf Valves & Valve Boxes

*Water Precisely Where You Want It*



Model		220G Brass Series	P220G Series	P220GS Series Scrubber
<b>Catalog Pages</b>		<b>91-92</b>	<b>93-94</b>	<b>93-94</b>
<b>Flow Range</b>		5.0-180 gpm	5.0-180 gpm	5.0-150 gpm
<b>Operating Pressure</b>		10-220 psi max	10-220 psi max	10-220 psi max
<b>Conditions</b>	Electrically Activated Systems	X	X	X
	Pressure Regulated Systems	X	X	X
	Effluent Water	X	X	X
<b>Sizes</b>	1"	X	X	X
	1 1/4"	X		
	1 1/2"	X	X	X
	2"	X	X	X
<b>Configurations</b>	Inline/Globe	X	X	X
	Angle/Globe		X	X
<b>Inlet/Outlet</b>	Threaded (Female)	X	X	X
<b>Features</b>	Manual Flow Control	X	X	X
	Pressure Regulation	X	X	X
	Internal Manual Bleed	X	X	X
	External Manual Bleed (Flush)	X	X	X
<b>Body Construction</b>	Glass-filled Nylon		X	X
	Brass	X		
<b>Warranty</b>		5 Years	5 Years	5 Years



**A full line of valve boxes Pg. 95**

- fit valves up to 4"
- 1-, 2- and 4- station LSM modules





# 220G Brass Series Valves

## Specifications

### Operational

- **Flow Range:**
  - 1" model: 1 to 40 gpm
  - 1¼" model: 20 to 100 gpm
  - 1½" model: 20 to 120 gpm
  - 2" model: 30 to 170 gpm
- **Operating Pressure:** 10 to 220 psi
- **Pressure Regulating:**
  - Outlet (EZR-100): 5 to 100 psi ± 3
  - Minimum flow requirement of 5 gpm
- **Minimum Pressure Differential** (between inlet and outlet)  
**for Pressure Regulation:**
  - 1", 1¼", and 1½" models: 10 psi
  - 2" models: 20 psi
- **Burst Pressure Safety Rating:** 750 psi
- **Body Styles:**
  - Globe orientation – 1", 1¼", 1½", and 2" models, female threads

### Warranty

- Five years

### Dimensions

- **1" model:** 5 ¼" H x 5" W
- **1¼" model:** 6 ½" H x 6" W
- **1½" model:** 6 ½" H x 6" W
- **2" model:** 7 ½" H x 7" W

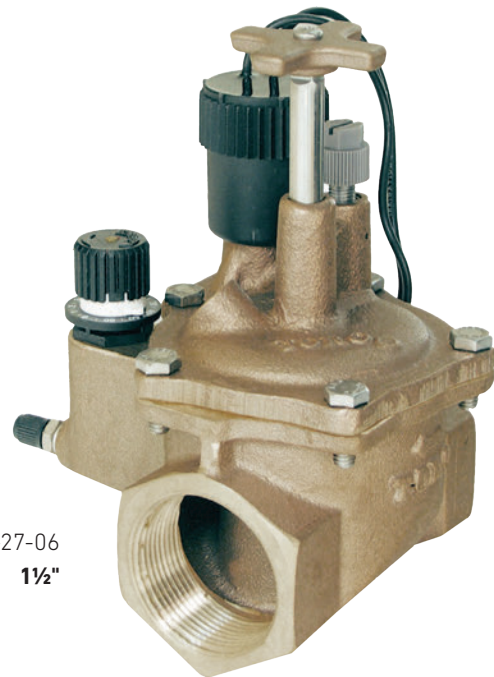

220G-27-06  
1½"

### Additional Features

- ✓ EZReg® Pressure Regulator can be installed as a service kit without having to drain the main line
- ✓ Pressure regulates in electric or manual modes, and is serviceable under pressure
- ✓ Built-in Schrader-type valve is standard on all models for fast downstream pressure verification
- ✓ Manual Flow Control; adjustable to full shut-off
- ✓ Robust, double-beaded, fabric-reinforced rubber diaphragm
- ✓ Commercial-grade 316 Stainless Steel stem for maximum corrosion resistance



# 220G Brass Series Valves

## Specifications

### 220G Brass Series Model List

Model	Description
Pressure Regulated with EZREG <sup>®</sup>	
220G-27-04	1" Inlet/Outlet; Globe
220G-27-05	1 1/4" Inlet/Outlet; Globe
220G-27-06	1 1/2" Inlet/Outlet; Globe
220G-27-08	2" Inlet/Outlet; Globe



220G-27-04  
1"

### 220G Brass Series Pressure Loss Data

Model	Type	Gallons Per Minute																		
		5	10	15	20	30	40	50	60	70	80	100	120	150	170	180	200	250	300	350
1"	Electric	1.8	2.0	2.2	3.1	5.1	7.8													
1 1/4"	Electric				1.9	2.5	2.7	3.5	4.1	5.6										
1 1/2"	Electric				2.2	2.5	2.8	3.1	3.8	5.0	6.6									
2"	Electric					3.1	3.2	2.9	3.0	3.3	3.4	4.5	6.6	10.1	13.5	14.9				

Notes: For optimal performance when designing a system, it is recommended that total Pressure Loss be calculated to ensure sufficient downstream pressure. For optimum pressure regulation performance, size regulating valves towards the higher flow ranges. Flow rates are recommended not to exceed 5 psi loss.

### Specifying Information — 220G Brass Series

220G-27-0XXX			
Type	Body Style	Size	Optional
<b>220G</b>	<b>27</b>	<b>0X</b>	<b>XX</b>
220G—220G Brass Series Valve	27—NPT, Pressure-regulated (5–100 psi)	4—1" 5—1 1/4" 6—1 1/2" 8—2"	DL—Latching Solenoid for 2-wire LSM Systems E—Effluent

**Example:** A 1" NPT pressure-regulated, 220G Brass Series Valve with 60 Hz solenoid, would be specified as: **220G-27-04**



## Specifications

### Operational

- **Flow Range:**
  - 1" – 5 to 40 gpm
  - 1½" – 30 to 110 gpm
  - 2" – 80 to 180 gpm
- **Operating Pressure** (220 psi maximum pressure rating):
  - 1" – 1½" – 10 to 220 psi
  - 2" – 20 to 220 psi
- **EZReg® Pressure regulating:**
  - Outlet: 5 to 100 psi ± 3 psi
- **Inlet:** 10 to 220 psi
- **Minimum pressure differential** (between inlet and outlet) for pressure regulation: 10 psi
- **Burst pressure safety rating:** 750 psi
- **Body styles:**
  - Globe/Angle – 1", 1½", 2" female threads
- **Spike Guard™ Solenoid:** 24 VAC (50/60 Hz) Standard
  - Inrush: 60 Hz: 0.12 amps
  - Holding: 60 Hz: 0.1 amps
- DC latching – momentary low voltage pulse

### Warranty

- Five years

### Additional Features

- ✓ Glass-filled nylon and stainless steel construction
- ✓ Internal and External bleed
- ✓ No external tubing
- ✓ Standard, built-in Schrader-type valve for downstream pressure verification
- ✓ Flow control independent of solenoid
- ✓ Self-aligning bonnet to ensure correct installation
- ✓ Self-cleaning, stainless steel metering rod
- ✓ Low-flow capability down to 5 gpm
- ✓ Low-power requirement for longer wire runs

### Dimensions

- 1" – 6¾" H x 3⅝" W
- 1½" – 7¼" H x 3⅝" W
- 2" – 9½" H x 6⅛" W

P220G-27-08

2"



P220G-27-04

1"



P220G-27-06

1½"

**TORO**

# P220G & P220GS Series Valves

## Specifications

### Valve Wire Sizing Chart

Maximum One-way Distance (in ft.) Between Controller and Valve Using Spike-Guard™ Solenoid\*

Ground Wire	Control Wire						
	18	16	14	12	10	8	6
18	2040	2520	2940	3280	3540	3720	3860
16	2520	3260	4000	4660	5220	5620	5920
14	2940	4000	5180	6360	7420	8300	8960
12	3280	4660	6360	8240	10100	11800	13180
10	3540	5220	7420	10100	13180	16060	18770
8	3720	5260	8300	11800	16060	20800	25540
6	3860	5960	8960	13180	18700	25540	33080

\* Solenoid Model: 24 V ac  
 Pressure: 150 psi  
 Voltage Drop: 4 V  
 Minimum Operating Voltage: 20 V  
 Amperage (peak) 0.12 A

### ACT™ System

Toro's patented technology employs a constantly rotating turbine to clean the metering/filtration area. This ensures that dirt, algae and particulates do not impede valve performance.

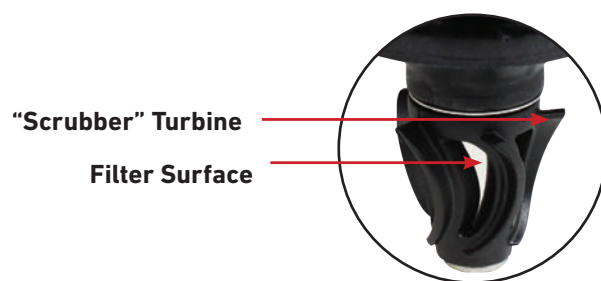

### P220G Series Friction Loss Data\*

Size	Configuration	gpm Flow																	
		5	10	20	30	40	50	60	70	80	90	100	110	120	130	140	150	180	
1"	Globe	4.00	4.20	3.20	4.10	7.20													
	Angle	4.00	4.20	3.10	2.70	4.80													
1 1/2"	Globe				1.60	2.30	3.60	5.20	7.00	9.20	11.20	13.60	16.40						
	Angle				1.30	1.60	2.80	4.00	5.50	7.10	8.90	10.90	13.50						
2"	Globe									2.10	2.70	3.30	4.00	4.80	5.60	6.50	7.50	8.70	
	Angle									1.20	1.60	2.00	2.40	2.80	3.30	3.90	4.40	5.20	

### P220GS Series Friction Loss Data\*

Size	Configuration	gpm Flow																
		5	10	20	30	40	50	60	70	80	90	100	110	120	130	140	150	
1"	Globe	4.63	4.74	3.10	6.05	10.75												
	Angle	4.14	4.64	2.54	5.53	9.46												
1 1/2"	Globe			1.14	1.56	2.85	4.36	6.28	8.57	11.20	14.03	17.20	20.46					
	Angle			0.95	1.51	2.28	3.69	5.29	6.97	9.26	11.80	14.60	17.40					
2"	Globe									3.57	4.62	5.33	6.80	8.20	9.02	10.46	11.61	
	Angle									2.79	3.50	4.41	5.62	6.39	7.35	8.81	9.37	

\*Note: For optimum performance when designing a system, be sure to calculate total friction loss to ensure sufficient downstream pressure. For optimum regulation performance, size regulating valves toward the higher flow ranges. Flow rates are recommended not to exceed 5 psi loss.

### Specifying Information — P220G and P220GS Series

P220GS-27-0X-XXX			
Type	Body Style	Size	Optional
<b>P220GS</b>	<b>27</b>	<b>0X</b>	<b>XXX</b>
P220G—P220G Series Plastic Valve P220GS—P220GS Plastic Scrubber Valve	27—NPT, Pressure-regulated (5–100 psi)	4—1" 6—1 1/2" 8—2"	E—Effluent DL—DC Latching Solenoid for LSM System DLE—DC Latching Solenoid for LSM System, Effluent
<b>Example:</b> A 1" P220G Series plastic electric, pressure-regulating valve with a 60 Hz solenoid, would be specified as: <b>P220G-27-04</b>			



# Valve Boxes

## Specifications

### Specifying Information — Round Valve Boxes

TVB-XXRND-XX		
Type	Size	Color Description
<b>TVB</b>	<b>XXRND</b>	<b>XX</b>
TVB—Toro® Valve Box	6—6" Round 7—7" Round 10—10" Round	Blank— Green lid and black box G—Green lid and box GY—Gray lid and box (electrical) T—Tan lid and box E—Purple lid and box (effluent) BK—Black lid and box BR—Brown lid w/black box
<b>Example:</b> A Toro 7" round valve box for effluent water applications would be specified as: <b>TVB-7RND-E</b>		

Description	A Length	B Width	C Height	Weight (lbs)
6"	6.3"	8.1"	9.0"	1.15 lbs
7"	6.8"	9.3"	9.0"	1.80 lbs
10"	9.9"	13.0"	10.3"	3.39 lbs



### Rectangular Valve Boxes

TVB-XXXX-XX-XX			
Type	Size	Height	Color Description
<b>TVB</b>	<b>XXXX</b>	<b>XX</b>	<b>XX</b>
TVB—Toro Valve Box	1217—12"X17" 1521—15"X21"	6—6" High 12—12" High	Blank— Green lid and black box G—Green lid and box GY—Gray lid and box (elect.) T—Tan lid and box E—Purple lid and box (effluent) BK—Black lid and box BR—Brown lid w/black box
<b>Example:</b> A Toro 12x17x6 rectangular valve box for effluent water applications would be specified as: <b>TVB-1217-6-E</b>			

### Rectangular Extensions

TVB-XXXX-EXT6BOX-XX			
Type	Size	Height	Color Description
<b>TVB</b>	<b>XXXX</b>	<b>EXT6BOX</b>	<b>XX</b>
TVB—Toro Valve Box	1217—12"X17" 1521—15"X21"	EXT6BOX—6" High	Blank— Black box G—Green box GY—Gray box (elect.) T—Tan box E—Purple box (effluent)
<b>Example:</b> A Toro 6" extension for a 12"x17" tan valve box would be specified as: <b>TVB-1217-EXT6BOX-T</b>			

Description	A Length	B Width	C Height	Weight (lbs)
12x17x6	18.8"	13.8"	6.8"	6.71 lbs
15x21x6	24.3"	17.8"	6.9"	8.89 lbs

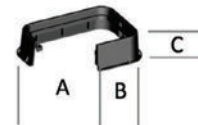

Description	A Length	B Width	C Height	Weight (lbs)
12x17x6	18.8"	13.8"	6.8"	6.56 lbs
12x17x12	21.0"	16.0"	12.3"	9.05 lbs
15x21x6	24.3"	18.8"	7.2"	8.75 lbs
15x21x12	25.7"	19.1"	12.3"	12.11 lbs

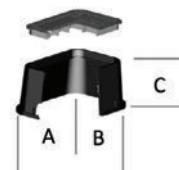



# Valve Boxes

## Specifications

### Rectangular Valve Box Separates

TVB-XXXX-LID-XX			
Type	Size	Height	Color Description
<b>TVB</b>	<b>XXXX</b>	<b>LID</b>	<b>XX</b>
TVB—Toro® Valve Box	1217—12"X17" 1521—15"X21"	LID—Lid	Blank—Green lid G—Green lid GY—Gray lid (elect.) T—Tan lid E—Purple lid (effluent) BK—Black lid BR—Brown lid
<b>Example:</b> A Toro 12x17 rectangular valve box lid for effluent water applications would be specified as: <b>TVB-1217-LID-E</b>			

TVB-XXXX-XXXX		
Type	Size	Height
<b>TVB</b>	<b>XXXX</b>	<b>XX</b>
TVB—Toro Valve Box	1217—12"X17" 1521—15"X21"	6BOX—6" High valve box 12BOX—12" High valve box
<b>Example:</b> A Toro 12x17X6 rectangular valve box would be specified as: <b>TVB-1217-6BOX-BK</b>		

Description	A Length	B Width	C Height	Weight (lbs)
12"x17" lid	16.9"	11.8"	2.0"	2.73 lbs
15"x21" lid	21.3"	14.9"	1.9"	3.23 lbs
12"x17"x6" box	18.8"	13.8"	6.8"	3.83 lbs
12"x17"x12" box	21"	16"	12.3"	6.32 lbs
15"x21"x6" box	24.3"	17.8"	6.9"	5.66 lbs
15"x21"x12" box	25.7"	19.1"	12.3"	8.88 lbs

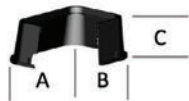
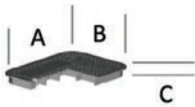

### Round Valve Box Separates

TVB-XXXXX-XX		
Type	Size Box or Lid	Color Description
<b>TVB</b>	<b>XXXXX</b>	<b>XX</b>
TVB—Toro Valve Box	6LID—6" Round lid 7LID—7" Round lid 10LID—10" Round lid BOX6—6" Box (black only) BOX7—7" Box (black only) BOX10—10" Box (black only)	G—Green lid GY—Gray lid (electrical) T—Tan lid E—Purple lid (effluent) BK—Black lid BR—Brown lid
<b>Example:</b> A Toro 7" round valve box lid for effluent water applications would be specified as: <b>TVB-7LID-E</b>		

Description	A Length	B Width	C Height	Weight (lbs)
6" lid	6.3"	8.1"	1.2"	.31 lbs
7" lid	6.8"	9.3"	1.7"	.52 lbs
10" lid	9.9"	13.0"	2.1"	1.13 lbs



Description	A Length	B Width	C Height	Weight (lbs)
6" box	6.3"	8.1"	9.0"	.77 lbs
7" box	6.8"	9.3"	9.0"	1.19 lbs
10" box	9.9"	13.0"	10.3"	2.26 lbs

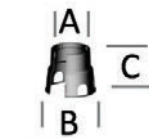



# Dry Boxes

## Specifications

### Operational

Static Vertical Load Rating: SCTE – Light Duty, Pedestrian		
Properties of Base Material	ASTM Test Method	HDPE
Tensile Strength	D-638	2700-4,400 psi (Typical Range)
Flexural Modulus	D-790	Minimum 140,000 not to exceed 24,000 psi
Notched Izod Impact Strength	D-256	0.5 - 3.0 (Typical Range)
Deflection Temperature @ 66psi	D-648	150-200 F (Typical Range)
Density	D-792	Minimum 0.95- not to exceed 0.965
Electrical Dielectric Strength	D-149	400-600 V/mil (Typical Range)
Chemical Resistance	D-543	Very Resistant
Water Absorption	D-570	Less than 1% weight change

### Warranty

- Five years

### Specifying Information — Dry Box Valve Boxes

TVB-1217-12DB-XX			
Type	Size	Height	Color Description
TVB	1217	12DB	XX
TVB—Toro® Valve Box	1217—12"x17"	12DB—12" High Dry Box	Blank— Green lid and black box G—Green lid and box GY—Gray lid and box (elect.) T—Tan lid and box E—Purple lid and box (effluent) BK—Black lid and box BR—Brown lid w/black box
<b>Example:</b> A Toro 12"x17"x12" valve box for electrical applications would be specified as: <b>TVB-1217-12DB-GY</b>			

### Specifying Information — Dry Box Valve Boxes

TVB-12RND-DB-XX			
Type	Size	Height	Color Description
TVB	12RND	DB	XX
TVB—Toro Valve Box	12" Round	Dry Box	G—Green GY—Gray (electrical) T—Tan E—Purple (effluent) BK—Black BR—Brown
<b>Example:</b> A Toro 12" round Dry Box for effluent water applications would be specified as: <b>TVB-12RND-DB-E</b>			

Description	A Length	B Width	C Height	Weight (lbs)
12DB	21.0"	16.0"	12.3"	9.8 lbs

Description	A Length	B Width	C Height	Weight (lbs)
DBAP	11.5"	8.5"	.2"	0.99 lbs
DBDS	19.8"	14.5"	1.3"	2.8 lbs

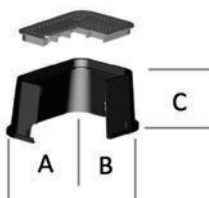

Description	A Length	B Width	C Height	Weight (lbs)
DB	11.5"	14.5"	12.75"	7.12 lbs

Accessories	
TVB-1217-DBAP	DRY BOX Accessory Plate
TVB-1217-DBDS	DRY BOX Dirt Skirt







# Dry Boxes

## Specifications

<b>A</b>	<b>Dual Bolt Retention Covers</b> Ensures proper sealing and vandal resistance.
<b>B</b>	<b>Heavy Duty Lid</b> Construction molded from High Density Polyethylene (H.D.P.E), available in Green, Tan, Purple, Black, Gray and Brown.
<b>C</b>	<b>Accessory Plate</b> (optional) Attaches directly to the lid and allows attachments of various components like GDC modules, elec/hyd converters, battery operated controllers and more.
<b>D</b>	<b>Dual Seal Lid</b> Keeps water and critters from creeping in from the top.
<b>E</b>	<b>Heavy Duty Box</b> Construction molded from High Density Polyethylene (H.D.P.E), available in Green, Tan, Purple, Black, Gray and Brown.
<b>F</b>	<b>Dirt Skirt</b> (optional) Attaches directly to the bottom of the valve box and provides an outer seal to prevent intrusion from burrowing rodents, water and critters.

TVB-1217-DBAP (Accessory plate)

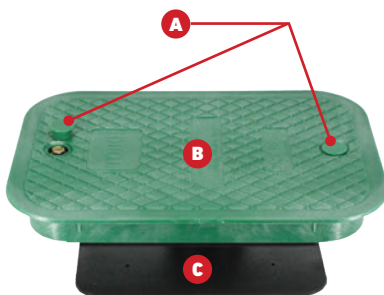

TVB-1217-DB (Dry Box)



TVB-12RND-DB (Round Dry Box)





# 470 Quick Coupler Valve

## Specifications

### Operational

- ✓ Full range of flows from 0 to 100 gallons per minute
- ✓ ¾", 1" and 1½" one- and two-piece single-lug models including ACME thread key connections to meet a variety of installation requirements
- ✓ Hose swivel provides 360° movement without hose tangling for ease of use
- ✓ A variety of sizes meet various applications
- ✓ Metal and vinyl locking and non-locking covers
- ✓ Effluent (lavender-colored) locking cover

### Warranty

- Five years



Whether it's for hand watering the hot spots, fertilizer wash in, washing down equipment or filling the sprayer and lakes **the 400 Series provides** a full family of quick coupling valves and accessories that connect you directly to the main water source to fill all your hand watering needs.





# 470 Quick Coupler Valve

## Specifications

### 470 Series Friction Loss Data

Model	gpm Flow											
	10	15	20	25	30	35	40	50	60	70	85	100
473	1.5	3.1	5.3	8.5								
474			1.1	2.2	3.6	5.7	8.0					
475				1.0	1.8	2.7	3.6	6.4	9.8			
476							1.0	1.7	2.6	3.6	5.6	8.8

*Note: For optimum sprinkler performance when designing a system, be sure to calculate total friction loss to ensure sufficient downstream pressure. Flow rates are recommended not to exceed 5 psi loss. Values listed in psi.*

### Ordering Information — Quick Coupler Valve Accessories

Order Number	Description
463-01	1/2" Female, 3/4" Male, Single-lug Coupler Key
464-01	3/4" Female, 1" Male, Single-lug Coupler Key
464-02	1" Female, Single-lug Coupler Key
464-03	1" ACME Thread Coupler Key
465-01	1 1/4" Inlet, 3/4" Female, 1" Male, Single-lug Coupler Key
466-01	1 1/4" Female, 1 1/2" Male, Single-lug Coupler Key
477-00	3/4" Female NPT x 3/4" MHT Hose Swivel
477-01	1" Female NPT x 3/4" MHT Hose Swivel
477-02	1" Female NPT x 1" MHT Hose Swivel

### Specifying Information — Quick Couplers

Toro Model Number	Description	Inlet Size NPT Threads	Body Type	Outlet Key Size	Corresponding Key(s)	Valve Cover Type	Corresponding Swivel(s)*		
							477-00	477-01	477-02
473-00	QCV .75, SS CVR	3/4"	1 Piece	3/4"	463-01	Stainless Steel	A	B	B
474-00	QCV 1, SS CVR	1"	1 Piece	1"	464-01/464-02	Stainless Steel	B	A/B	A/B
474-01	QCV 1, VYL CVR	1"	1 Piece	1"	464-01/464-02	Yellow Vinyl, Spring Loaded	B	A/B	A/B
474-03	QCV 1, VYL CVR, W/LK	1"	1 Piece	1"	464-01/464-02	Yellow Vinyl, Locking, Spring Loaded	B	A/B	A/B
474-04	QCV 1, LAV VYL CVR	1"	1 Piece	1"	464-01/464-02	Lavender Vinyl, Locking, Spring Loaded	B	A/B	A/B
474-21	QCV 1, VYL CVR, 2PC	1"	2 Piece	1"	464-01/464-02	Yellow Vinyl, Spring Loaded	B	A/B	A/B
474-24	QCV 1, LAV VYL CVR, 2PC	1"	2 Piece	1"	464-01/464-02	Lavender Vinyl, Locking, Spring Loaded	B	A/B	A/B
474-40	QCV 1, SS CVR, ACME	1"	1 Piece	1"	464-03	Stainless Steel	B	A	A
474-41	QCV 1, VYL CVR, ACME	1"	1 Piece	1"	464-03	Yellow Vinyl, Spring Loaded	B	A	A
474-44	QCV 1, LAV VYL CVR, W/LK, ACME	1"	1 Piece	1"	464-03	Lavender Vinyl, Locking, Spring Loaded	B	A	A
475-00	QCV 1.25, SS CVR	1"	1 Piece	1 1/4"	465-01	Stainless Steel	B	B	B
475-01	QCV 1.25, VYL CVR	1"	1 Piece	1 1/4"	465-01	Yellow Vinyl	B	B	B
476-00	QCV 1.5, SS CVR	1 1/2"	1 Piece	1 1/2"	466-01	Stainless Steel	B	B	B
476-01	QCV 1.5, VYL CVR	1 1/2"	1 Piece	1 1/2"	466-01	Yellow Vinyl, Spring Loaded	B	B	B
476-04	QCV 1.5, LAV VYL CVR	1 1/2"	1 Piece	1 1/2"	466-01	Lavender Vinyl, Locking, Spring Loaded	B	B	B

\*A – Attaches directly to the quick coupler key. B – Requires additional fittings to be used with the quick coupler key.



# Wire Sizing

## Current Draw (Amperage)

### Standard Wattage Solenoid

Product	Solenoids	Assumes 24 VAC, 50/60 Hz Output			
		120 VAC, 60 Hz		240 VAC, 50 Hz	
		Inrush	Holding	Inrush	Holding
Lynx® Smart Satellite	0	—	0.20	—	0.19
	1	0.26	0.25	0.30	0.22
	2	0.35	0.30	0.34	0.25
	3	0.40	0.34	0.36	0.28
	4	0.46	0.39	0.39	0.30
	5	0.50	0.43	0.42	0.33
	6	0.64	0.48	0.44	0.36
	7	0.70	0.52	0.46	0.38
	8	0.73	0.56	0.50	0.41
	9	0.77	0.61	0.53	0.43
	10	0.80	0.65	0.57	0.46
	11	0.85	0.69	0.57	0.48
	12	0.91	0.73	0.57	0.51
	13	1.00	0.77	0.61	0.53
	14	1.03	0.81	0.62	0.55
	15	1.05	0.85	0.63	0.58
	16	1.14	0.88	0.66	0.60
OSMAC® G3 Satellite	0	0.05	0.05	0.03	0.03
	1	0.13	0.11	0.07	0.06
	2	0.21	0.17	0.12	0.09
	3	0.29	0.23	0.17	0.12
	4	0.37	0.29	0.21	0.15
	5	0.45	0.35	0.26	0.19
	6	0.53	0.41	0.31	0.22
	7	0.61	0.47	0.35	0.25
	8	0.69	0.53	0.40	0.28
	9	0.77	0.59	0.45	0.31
	10	0.85	0.65	0.50	0.35
	11	0.93	0.71	0.54	0.38
	12	1.01	0.77	0.59	0.41
	13	1.09	0.83	0.64	0.44
	14	1.17	0.89	0.68	0.47
	15	1.25	0.95	0.73	0.51
	16	1.33	1.01	0.81	0.54

### Spike Guard™ Low Wattage Solenoid

Product	Solenoids	Assumes 24 VAC, 50/60 Hz Output			
		120 VAC, 60 Hz		240 VAC, 50 Hz	
		Inrush	Holding	Inrush	Holding
Lynx Smart Satellite	0	—	0.20	0.21	0.20
	1	0.24	0.22	0.22	0.21
	2	0.26	0.24	0.23	0.22
	3	0.29	0.27	0.24	0.23
	4	0.31	0.29	0.25	0.24
	5	0.33	0.31	0.26	0.26
	6	0.35	0.33	0.28	0.27
	7	0.39	0.37	0.29	0.28
	8	0.41	0.39	0.30	0.30
	9	0.43	0.41	0.32	0.31
	10	0.46	0.44	0.34	0.33
	11	0.47	0.46	0.35	0.35
	12	0.49	0.48	0.36	0.36
	13	0.52	0.50	0.37	0.38
	14	0.54	0.52	0.38	0.39
	15	0.56	0.54	0.40	0.40
	16	0.58	0.56	0.43	0.42
	17	0.60	0.58	0.44	0.43
	18	0.61	0.60	0.46	0.45
	19	0.63	0.62	0.47	0.46
	20	0.66	0.64	0.49	0.48
	21	0.68	0.66	0.50	0.49
	22	0.70	0.68	0.51	0.50
	23	0.74	0.70	0.53	0.52
	24	0.76	0.72	0.54	0.53
	25	0.79	0.74	0.55	0.54
	26	0.80	0.75	0.57	0.56
	27	0.85	0.77	0.58	0.57
	28	0.90	0.79	0.59	0.58
	29	0.93	0.81	0.60	0.59
	30	0.96	0.82	0.61	0.60
	31	1.01	0.84	0.62	0.61
32	1.04	0.86	0.64	0.62	
OSMAC G3 Satellite	0	0.05	0.05	0.03	0.03
	1	0.07	0.07	0.05	0.05
	2	0.10	0.09	0.06	0.06
	3	0.12	0.11	0.08	0.08
	4	0.15	0.13	0.10	0.09
	5	0.17	0.15	0.12	0.11
	6	0.19	0.17	0.13	0.12
	7	0.22	0.19	0.15	0.14
	8	0.24	0.21	0.17	0.15
	9	0.27	0.23	0.18	0.17
	10	0.29	0.25	0.20	0.18
	11	0.31	0.27	0.22	0.20
	12	0.34	0.29	0.23	0.21
	13	0.36	0.31	0.25	0.23
	14	0.39	0.33	0.27	0.24
	15	0.41	0.35	0.29	0.26
	16	0.44	0.37	0.30	0.27

### Conversion Information

- All gallons per minute are shown in U.S.
- To convert to imperial gallons per minute, multiply by 0.833
- To convert to liters per minute, multiply by 3.78
- To convert pounds per square inch (psi) to atmospheres, divide by 14.7
- To convert pounds per square inch (psi) to kilograms per square centimeter (kg/cm2), divide by 14.22
- To convert feet to meters, divide by 3.28

### Winterizing Specifications

In freezing climates, valves should be properly winterized to prevent freeze-related damage.

### Sprinkler Spacing

Toro® does not recommend designing for zero (0) mph wind conditions.

- **Square Spacing**
  - No wind - 55% of diameter
  - 4 mph wind - 50% of diameter
  - 6,4 kph wind - 50% of diameter
  - 8 mph wind - 45% of diameter
  - 12,8 kph - 45% of diameter
- **Triangular Spacing**
  - No wind - 60% of diameter
  - 4 mph wind - 55% of diameter
  - 6,4 kph wind - 55% of diameter
  - 8 mph wind - 50% of diameter
  - 12,8 kph - 50% of diameter
- **Single Row Spacing**
  - No wind - 50% of diameter
  - 4 mph wind - 50% of diameter
  - 6,4 kph wind - 50% of diameter
  - 8 mph wind - 45% of diameter
  - 12,8 kph - 45% of diameter

Design in consideration of the worst wind conditions.

### Precipitation Rate Formulas

- **Square-spaced sprinklers in pattern:**

$$\frac{\text{gpm of full-circle} \times 96.3}{(\text{Spacing})^2}$$

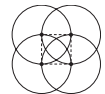

- **Triangular-spaced sprinklers in pattern:**

$$\frac{\text{gpm of full-circle} \times 96.3}{(\text{Spacing})^2 (.866)}$$

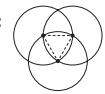

- **Area and flow:**

$$\frac{\text{Total gpm of zone} \times 96.3}{\text{Total irrigated square feet of zone}}$$



- **Single row:**

$$\frac{\text{gpm of full-circle} \times 96.3}{(\text{Spacing}) (\text{Scallop})}$$

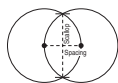



# Limited Warranty

The Toro Company and its affiliate, Toro Warranty Company, pursuant to an agreement between them, jointly warrants to the owner, each new piece of irrigation equipment (featured in the current catalog at date of installation) against defects in material and workmanship for a period described below, provided they are used for irrigation purposes under manufacturer's recommended specifications and instructions.

During the warranty period, we will repair or replace, at our option, any part found to be defective. Your remedy is limited solely to the replacement or repair of defective parts.

This warranty does not apply (i) to Acts of God (e.g., lightning, flooding, etc.); or (ii) to products not manufactured by Toro when used in conjunction with Toro products; or (iii) where equipment is used, or installation is performed in any manner contrary to Toro's specifications and instructions, or where equipment is altered or modified.

Return the defective part to your irrigation contractor or installer, or your local Golf Irrigation Distributor, or contact:

**The Toro Company**  
5825 Jasmine Street  
Riverside, CA 92504  
(800) 664-4740

For the location of your nearest Toro distributor outside the U.S., call: (951) 688-9221.

Neither Toro nor Toro Warranty Company is liable for indirect, incidental or consequential damages in connection with the use of equipment, including but not limited to: vegetation loss, the cost of substitute equipment or services required during periods of malfunction or resulting non-use,

property damage or personal injury resulting from installer's actions, whether negligent or otherwise.

Some states do not allow the exclusion of incidental or consequential damages, so the above exclusion may not apply to you. All implied warranties, including those of merchantability and fitness for a particular purpose, are limited to the duration of this express warranty. Some states do not allow limitations on how long an implied warranty lasts, so the above limitation may not apply to you.

This warranty gives you specific legal rights and you may have other rights which vary from state to state. Proof of installation date required for any warranty claim and for any product covered by this warranty.

## Lynx® Smart Satellite

Lynx Smart Satellite is covered by this warranty for 2 years from the date of installation.

## Golf Sprinklers

All Toro golf sprinklers and conversion assemblies are covered by this warranty for 3 years from the date of installation.

All Toro golf sprinklers purchased and installed with a Toro swing joint will be covered by a 5 year warranty\*. Proof of simultaneous installation required for any warranty claim.

INFINITY® Series add-on accessories will be covered by a 1 year warranty.

\*Excludes 590GF Series and sprinkler conversion assemblies.

## Swing Joints

Toro swing joints are covered by this warranty for 5 years from the date of installation. Warranty covers defects in manufacturing and excludes damage resulting from natural phenomena such as frost heave.

## Valves

220G Series, P-220G Series and P-220GS Series valves are covered by this warranty for 5 years from date of installation. 470 Series quick coupler valves are covered by this warranty for 2 years from date of installation.

## DL2000™ Subsurface Drip Irrigation

Toro DL2000™ Subsurface Drip Irrigation products are covered by this warranty for 2 years from date of installation.

## Control Systems, Turf Guard®, Valve Boxes, and Dry Boxes

All Toro golf control systems (central controls, field satellite controllers, GDC, Turf Guard and Sensor Input Kits), Valve Boxes and Dry Boxes, unless covered by a Toro NSN® Support Plan, are covered by this warranty for 1 year from date of installation.

## Lynx Smart Module

Lynx Smart Module is covered by this warranty for 3 years from the date of installation. This includes modules that are purchased as a component of an INFINITY or FLEX800™ Series sprinkler. If those sprinklers are purchased and installed with a Toro swing joint, the Lynx Smart Module is covered for 5 years.

*We reserve the right to improve our products and make changes in the specifications and designs without notice and without incurring obligation. Products depicted in this brochure are for demonstration purposes only. Actual products offered for sale may vary in design and features.*





# Irrigation Resources & Support

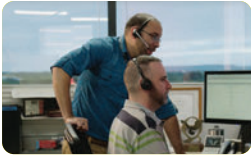

## Technical Support

From helping superintendents program controllers, to troubleshooting complex system issues with consultants, our highly skilled support team provides years of irrigation experience that you can count on.

**For exceptional technical support, call 1-877-345-TORO (8676).**

---



## Irrigation Parts, Services, & Exchanges

Through your distributor, Toro® Irrigation provides controller boards ready for immediate board exchange to assure that your golf course and reputation stay protected. **For immediate assistance call: 1-877-345-TORO (8676) or visit [toro.com/irrigationparts](http://toro.com/irrigationparts)**

---



## Irrigation Distributor Support

Toro's extensive distributor network is the most experienced and knowledgeable in the industry. Many have first-hand experience in course and irrigation management so you can trust that they know the business and what's important to you.

*(See page 105 for a list of Toro Golf Irrigation Distributors)*

---

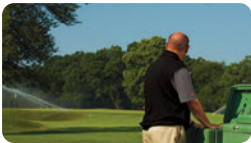

## Irrigation Field Service

With some of the most knowledgeable and helpful field service staff in the industry, and our extensive training and support programs; Toro field service personnel are always ready to assist—before, during, and well after a sale.

---



## Irrigation Financing

By offering a variety of customized, competitive financing plans, Toro gives you "one-stop shopping" eliminating the need for third-party funding. You can improve your course without draining your budget.

---



## Toro National Support Network (NSN®)

A global team of certified technicians and licensed irrigators dedicated to the daily operations and maintenance of computerized central control systems for Toro Irrigation customers worldwide. *(See page 104 for more information.)*

# Real People. Genuine Toro® Parts. Global Support. **24 hours, 365 days a year.**

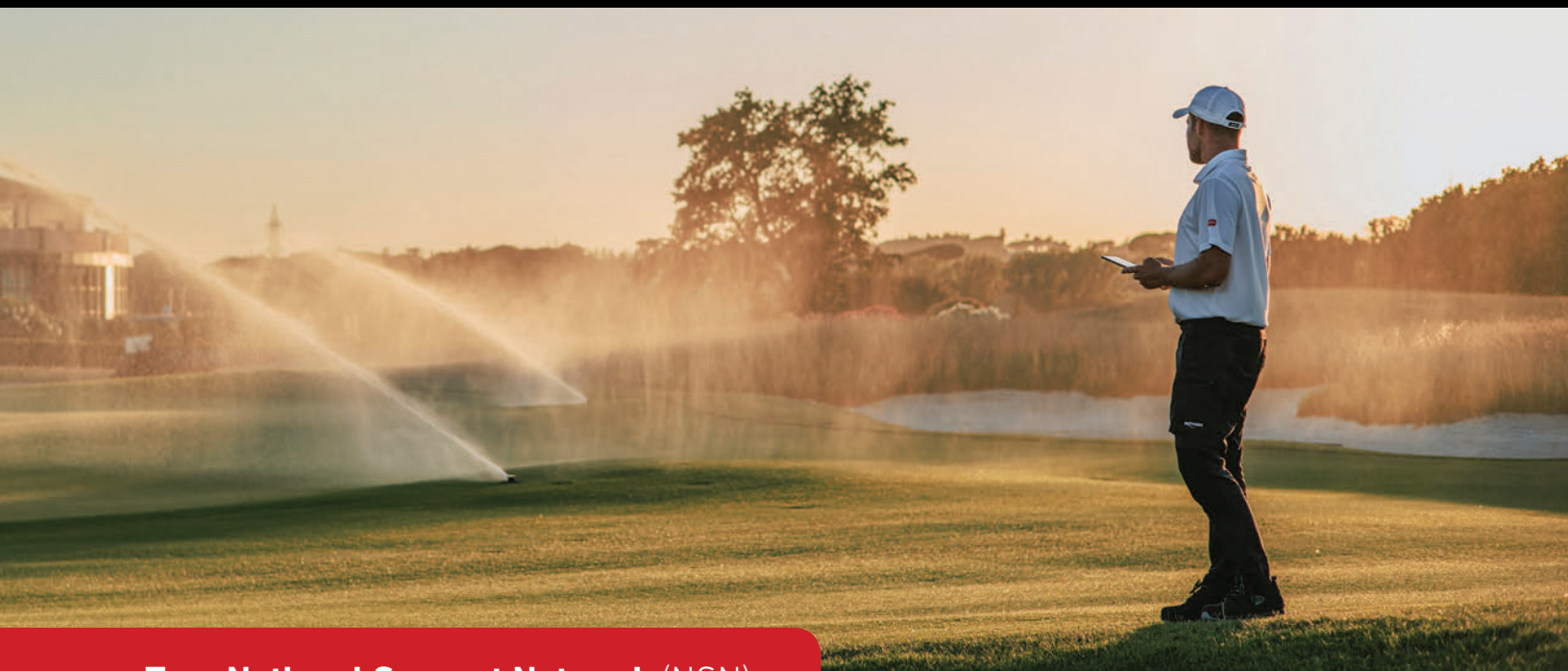

## Toro National Support Network (NSN)

- > **Toro NSN® was founded over 30 years ago**, the first dedicated customer support network in the irrigation industry.
- > **A global team of dedicated technical support specialists**, including licensed irrigators with an average tenure of 10 years of Toro NSN experience.
- > **We are here to provide you with confidence and peace of mind** with complete central control operational assurance, mobile app features and functionality, and extended hardware warranty replacement.
- > **We are here to support you and keep you irrigating** 24 hours a day, 7-days a week, 365 days a year.

***Start protecting your golf course today and experience the difference with Toro National Support Network.***

Call toll-free **1 (888) 676-TORO (8676)**

[www.toro.com/nsn](http://www.toro.com/nsn)



## What Services Does NSN Provide?

- > **1-800-ASK-TORO** – we are here to provide you with unmatched central control support 24 hours a day, 7 days a week, 365 days a year.
- > **Extended warranty, with next-business-day shipping** hardware replacement of central control system, fulfilled by qualified Toro technicians.
- > **Remote access to your central control system**, allowing you to control your irrigation when you are outside of the office.
- > **NSN Portal** – a web-based customer portal providing a knowledge-sharing database, on-line chat, & training.
- > **Training events** – web-based and in-person training seminars are included in select NSN renewal plans.

## Sales & Renewals:

Call 1-888-676-TORO (8676) or email [NSNSales@toro.com](mailto:NSNSales@toro.com) to enroll in a service plan to support your facility.



# Golf Irrigation Distributors



### American Golf Partners (a-z)

- 1.) Century Equipment, Inc.  
(419) 865-7400
- 2.) E. H. Griffith, Inc.  
(412) 271-3365
- 3.) Grassland Equipment & Irrigation Corp.  
(518) 785-5841
- 4.) Ness Turf Equipment  
(808) 486-8300
- 5.) Hector Turf  
(954) 429-3200
- 6.) Jerry Pate Turf & Irrigation, Inc.  
(850) 479-4653
- 7.) Kenney Machinery Corp.  
(317) 872-4793
- 8.) L. L. Johnson Distributing Company  
(303) 320-1270

- 9.) Midland Implement Company, Inc.  
(406) 248-7771
- 10.) Midwest Turf & Irrigation, Inc.  
(402) 895-8900
- 11.) MTI Distributing, Inc.  
(763) 592-5600
- 12.) Professional Turf Products  
(817) 785-1900
- 13.) Reinders, Inc.  
(262) 786-3300
- 14.) Simpson Norton Corporation  
(623) 932-5116
- 15.) Smith Turf & Irrigation L.L.C.  
(704) 393-8873
- 16.) Spartan Distributors, Inc.  
(616) 887-7301
- 17.) Storr Tractor Company  
(908) 722-9830

- 18.) Turf Equipment & Irrigation  
(801) 566-3256
- 19.) Turf Equipment & Supply Company, Inc.  
(410) 799-5575
- 20.) Turf Products L.L.C.  
(860) 763-3581
- 21.) Turf Star Western  
(800) 585-8001
- 22.) Wesco Turf Inc.  
(941) 377-6777

### Canadian Golf Partners (a-z)

- 23.) Oakcreek Golf and Turf Inc.  
(403) 279-2907
- 24.) Turf Care Products Canada  
(905) 836-0988







***Always solving. Always evolving.***

**#1 in Golf Irrigation & Equipment\***

**[www.toro.com](http://www.toro.com)**

**5825 Jasmine Street  
Riverside, CA 92504-1183  
Phone: 877-345-8676  
Fax: 800-862-8676**

**©2025 The Toro Company  
All Rights Reserved**

**PN: 25-5003-IG**

We reserve the right to improve our products and make changes in the specifications and designs without notice and without incurring obligation.

Products depicted in this brochure are for demonstration purposes only. Actual products offered for sale may vary in design and features.

\* Based on market share data from National Golf Foundation Turf Brand Health Survey 2022. This statement has not been evaluated or endorsed by any regulatory agency.



**[facebook.com/Toro.Company](https://facebook.com/Toro.Company)  
[twitter.com/torogolf](https://twitter.com/torogolf)  
[youtube.com/toro](https://youtube.com/toro)**